

UNRECORDED

~~CONFIDENTIAL~~

CLASSIFIED

FM 4-15

WAR DEPARTMENT

COAST ARTILLERY
FIELD MANUAL

✽

SEACOAST ARTILLERY
FIRE CONTROL AND POSITION
FINDING

5 November 1943

Dissemination of restricted matter.—The information contained in restricted documents and the essential characteristics of restricted material may be given to any person known to be in the service of the United States and to persons of undoubted loyalty and discretion who are cooperating in Government work, but will not be communicated to the public or to the press except by authorized military public relations agencies. (See also par. 18b, AR 380-5, 28 Sep 1942.)

UNCLASSIFIED

REGRADED _____ BY AUTHORITY

OF E.O. 10801

BY BAKERS ON 5 AUG 81

R

COAST ARTILLERY FIELD MANUAL
SEACOAST ARTILLERY

FIRE CONTROL AND POSITION FINDING

CHANGES }
No. 1 }

WAR DEPARTMENT,
WASHINGTON 25, D.C., 7 JULY 1944.

FM 4-15, 5 November 1943, is changed as follows:

■ 28. APPROXIMATE FORMULAS.—These formulas may * * * the relationship is:

$$\text{parallax (degrees)} = 57 \frac{AB}{AT}$$

or

$$\text{parallax (mils)} = 1,000 \frac{AB}{AT}$$

■ 46. AZIMUTH INSTRUMENT M1910A1 (DEGREES) (fig. 17).—
a. *Description.*

(2) The base provides * * * the horizontal movement. Its principal parts are the yoke, the traversing mechanism, the azimuth scale, micrometer, and the leveling mechanism. The telescope is * * * two level vials.

■ 104. DESCRIPTION OF BOARD.

c. *Ballistic correction mechanism.*

(4) The ballistic correction * * * (fig. 78), is plotted. On the newer charts, the elevation scale is in the form of an elevation-height of site grid. (See app. XII.)

■ 105. MOUNTING THE CHARTS. *a. General.*

(2) Where the guns are equipped with range drums and utilize range-range relations on the percentage corrector tape, considerable inaccuracy may result in angular travel computation if the range drum setting, as read from the percentage corrector, is set on the range scale of the ballistic correction chart. In this case, * * * percentage corrector M1. The procedure is discussed in detail in appendix XII.

(3) (Added.) Special corrections must be made on some older type ballistic charts to take care of time of flight errors caused by height of site. On newer charts, an elevation-height of site grid has been added. These modifications are covered fully in appendix XII.

b. Ballistic correction chart.

(3) Mount the ballistic * * * tighten the screws. If using a chart having an elevation-height of site grid (see app. XII), set index to zero elevation on the zero height of site line.

■ 127. CASE III ADJUSTMENT.

c. Aiming point and aiming rule.—Azimuth circles are * * * of the gun. If a fixed aiming point is used, this parallax introduces an error into all azimuths except that at which the orientation was made as mentioned in paragraph 124. It is desirable * * * to sight displacement. (See par. 132.)

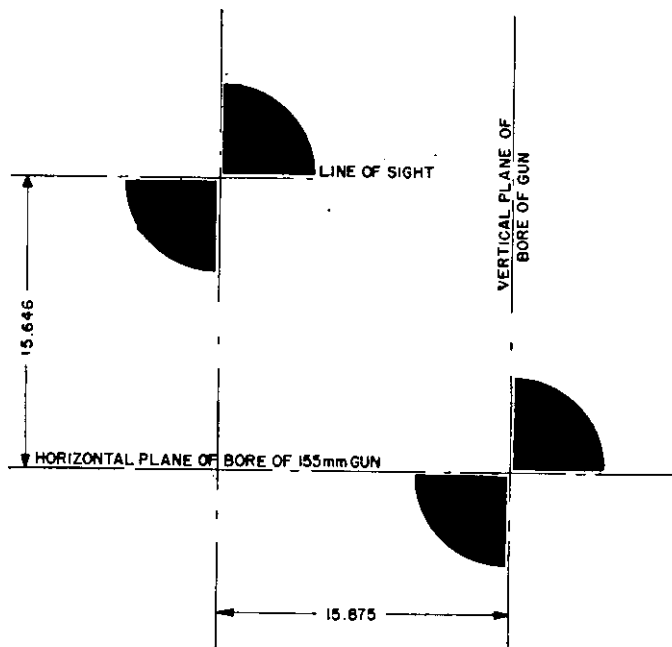

FIGURE 108.—Testing target for 155-mm gun G.P.F. equipped with quadrant sight M1918A1.

■ 211. MECHANICAL SOLUTION.

* * * * *

b. Application of data to the computer.

* * * * *

(14) The rate of change of range (\dot{R}_0) and the linear rate of lateral displacement ($R_0 \dot{A}_0$) are carried to the predictor mechanism which uses these rates in the solving of the prediction formulas. The computer solves * * * and adjustment corrections.

* * * * *

APPENDIX IV

MANEUVERABILITY OF NAVAL VESSELS

■ 3.

* * * * *

b. When the rudder * * * the drift angle. The average drift angle for a battleship is 10° ; that for a destroyer, 5° (see fig. 160).

* * * * *

FIRE CONTROL AND POSITION FINDING

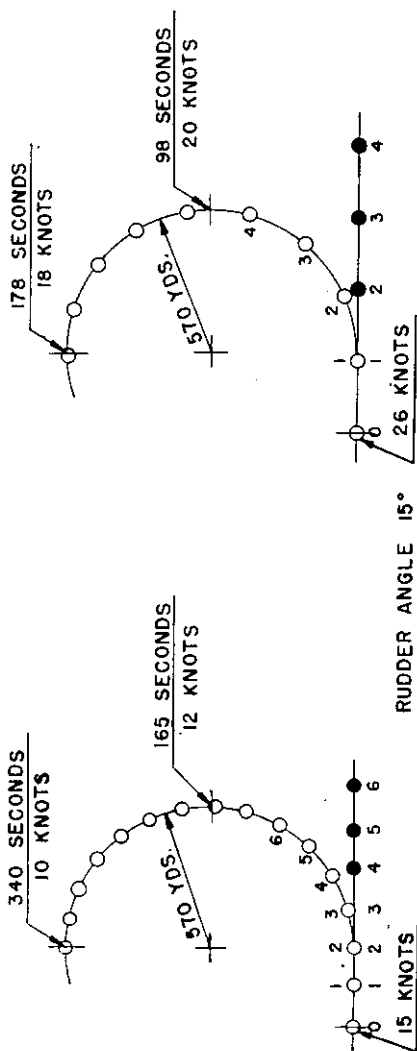

FIGURE 164.—Normal turns of an average battleship taken at 20-second intervals.

APPENDIX VI

CONSTRUCTION OF CHARTS AND SCALES FOR
SEACOAST ARTILLERY FIRE CONTROL INSTRUMENTS

■ 10. RANGE-ELEVATION SCALE FOR PERCENTAGE CORRECTOR M1.

* * * * *

c. A graphical method * * * on the scale. For example, the elevation marking for 440 mils should be placed opposite the range of 13,790 yards and that for 460 mils opposite the range of 14,100 yards. Figure 178 could * * * the 5-mil marks.

* * * * *

APPENDIX VII

INSTRUCTIONS FOR OBTAINING CHARTS AND SCALES
FOR SEACOAST FIRE CONTROL INSTRUMENTS
FROM THE COAST ARTILLERY BOARD, FORT MONROE,
VIRGINIA.

■ 3. AVAILABLE CHARTS AND SCALES.—Table I lists charts and scales available at the Coast Artillery Board, Fort Monroe, Virginia. This list will * * * writing these requests. The numerals following each item listed should be used in entering table II to determine the information which should be submitted to identify properly the chart or scale desired. The examples cited * * * all necessary information.

TABLE I.—*Available charts, scales, and plans*

* * * * *

4. *Deflection board M1.*

a. Wind and drift chart (1) (2) (3) (4) (5) (6).

Example: 2 each—Wind and drift chart for deflection board M1 for 155-mm guns M1 and M1A1 on mobile carriage M1; firing high-explosive shell M101 with point-detonating fuze M51, normal and supercharge, based on Firing Tables 155-S-1, azimuth in degrees and hundredths, elevation in mils, height of site, 100 feet.

* * * * *

APPENDIX X

DERIVATION OF PREDICTION FOR GUN DATA
COMPUTER M1

■ 1. SYMBOLS.—The following symbols * * * 192 and 194):

*	*	*	*	*
A_o	Azimuth of the line from G_1 to T_o (the present azimuth).			
$\overset{\circ}{A}_o$	Angular rate of change of present azimuth (radians per second).			
A_p	Azimuth of the line from G_1 to T_p (the predicted azimuth).			
*	*	*	*	*
R_o	Distance G_1 to T_o (present range).			
$\overset{\circ}{R}_o$	Rate of change of R_o (yards per second).			
R_p	Distance G_1 to T_p (predicted range).			
R_p'	Corrected predicted range.			
$R_o \overset{\circ}{A}_o$	Linear rate of lateral displacement (yards per second).			
t	Time of flight to T_p .			
*	*	*	*	*

■ 2. PREDICTION FORMULA FOR R_p .

c. From T_p , the * * * intersects at E . Now ET_o represents the product $\overset{\circ}{R}_o t$. With G_1 as * * * with radius $G_1 E$.

NOTE.— ET_o is the * * * the line $G_1 T_o$.

Then

$$R_p = R_o + ET_o + FT_p \tag{1}$$

$$ET_o = \overset{\circ}{R}_o t \text{ (see above)} \tag{2}$$

$$FT_p = R_p - G_1 F = R_p - G_1 E \tag{3}$$

$$G_1 E = R_p \cos \Delta A \quad (4)$$

$$FT_p = R_p - R_p \cos \Delta A = R_p (1 - \cos \Delta A) \quad (5)$$

From the power series

$$\cos \Delta A = 1 - \frac{\Delta A^2}{2!} + \frac{\Delta A^4}{4!} - \frac{\Delta A^6}{6!} + \dots \quad (6)$$

Substituting these values from (2) and (9) in (1)

$$R_p = R_o + \overset{\circ}{R}_o t + R_p \frac{\Delta A^2}{2} \quad (10)$$

By substitution of (10), we get

$$\begin{aligned} R_p &= R_o + \overset{\circ}{R}_o t + \left(R_o + \overset{\circ}{R}_o t + R_p \frac{\Delta A^2}{2} \right) \frac{\Delta A^2}{2} \\ &= R_o + \overset{\circ}{R}_o t + R_o \frac{\Delta A^2}{2} + \overset{\circ}{R}_o t \frac{\Delta A^2}{2} + R_p \frac{\Delta A^4}{4} \end{aligned} \quad (11)$$

Since $R_p \frac{\Delta A^4}{4}$ is very small, the term may be dropped.

$$\text{Then } R_p = R_o + \overset{\circ}{R}_o t + R_o \frac{\Delta A^2}{2} + \overset{\circ}{R}_o t \frac{\Delta A^2}{2} \quad (12)$$

$$\text{Then, by factoring } R_p = (R_o + \overset{\circ}{R}_o t) \left(1 + \frac{\Delta A^2}{2} \right) \quad (13)$$

Equation (13) gives of the target. If the range is decreasing, $\overset{\circ}{R}_o$ will be negative. (See fig. 193.)

■ 3. PREDICTION FORMULA FOR A_p .—In figure 194, of range prediction.

$$ET_p = R_o \overset{\circ}{A}_o t \quad (14)$$

$$R_p \Delta A = PT_p \quad (15)$$

$$ET_p = PT_p \text{ (for small angles, the chord equals its arc)}$$

$$R_p \Delta A = ET_p \text{ (by substitution)} \quad (16)$$

$$R_p \Delta A = R_o \dot{A}_o t \text{ (from (14))} \quad (17)$$

$$\Delta A = \frac{R_o \dot{A}_o t}{R_p} \quad (18)$$

$$A_p = A_o + \Delta A \text{ (by definition)} \quad (19)$$

$$A_p = A_o + \frac{R_o \dot{A}_o t}{R_p} \quad (20)$$

a. This assumes an increase in azimuth; that is, \dot{A}_o is positive. If travel is counterclockwise, \dot{A}_o will be minus.

b. Both predicted range and predicted azimuth are corrected for nonstandard ballistic conditions in the final solution.

FIRE CONTROL AND POSITION FINDING

APPENDIX XII (ADDED)

MODIFICATION OF RANGE OR ELEVATION SCALES ON BALLISTIC CHARTS FOR DEFLECTION BOARD M1

Paragraphs

SECTION I. General	1-5
II. Modification of older type ballistic charts	6-8
III. Elevation-height of site grid	9-12

SECTION I

GENERAL

■ 1. GENERAL.—Attention is called in paragraph 105a (2) and (3) to the possible necessity for correcting elevation or range scales on ballistic charts for deflection boards M1 when percentage corrector readings incorporate height of site corrections or range-range relation corrections made to accommodate a particular range disk. Attention is also called to the elevation-height of site grid appearing on the newer ballistic charts. The purpose of this appendix is to give a more detailed explanation of such modifications.

■ 2. PREPARATION OF BALLISTIC CHARTS.—*a.* In firing tables, time of flight and effects due to nonstandard ballistic conditions, as well as drift and rotation of the earth effects, are set forth as values corresponding to various level point ranges or quadrant elevations for zero height of site. Ballistic charts for deflection boards essentially are graphical representations of firing table data and the ordinate scale used initially in preparing the chart is the firing table range or quadrant elevation. Corresponding time of flight values are plotted opposite this scale. All range corrections for nonstandard conditions, except height of site but including tide, computed on the range correction board and applied on the percentage corrector to obtain corrected range or elevation can also be applied directly to this initial range or elevation scale on the ballistic chart for purposes of obtaining proper deflection ballistic corrections and time of flight values corresponding to the corrected range.

b. Under certain circumstances, ballistic charts prepared in the manner described in *a* above require modifications. These depend on the form in which range or elevation data are sent to the guns and how height of site correction or corrections for nonstandard ammunition (for guns equipped with range disks) are made.

(1) *Charts positioned according to range.*—In fixed batteries that are laid in elevation by means of a range disk, the height of site correction is taken care of in the graduation of the range disk. For batteries of this type, the ballistic chart on the deflection board is made with a range scale for positioning the chart. If the ammunition is the same as that for which the range disk is graduated, the range sent to the guns corresponds to a quadrant elevation corrected for everything except height of site and therefore may be used to position the ballistic chart (constructed for zero height of site) on the deflection board without error, regardless of the height of site of the battery. If the battery is using ammunition other than that for which the range disk is graduated, a range-range relation tape is used on the percentage corrector to obtain suitably corrected range readings for the guns. If these readings are used in positioning a ballistic chart bearing a range scale not similarly corrected, errors are introduced in the deflection ballistic correction and also in the time of flight value.

(2) *Charts positioned by means of elevation scale.*—If guns at an appreciable height of site are pointed in elevation by means of an elevation quadrant or indicator, the elevation sent to the guns is in mils (or, in a very few cases, degrees) and the quadrant elevation is that corresponding to a level point range equal to the map range corrected for all nonstandard conditions including height of site. If this elevation is used in positioning a ballistic chart bearing an elevation scale based on zero height of site, here again errors are introduced in the deflection ballistic correction and in the time of flight values.

■ 3. DEFLECTION BALLISTIC ERRORS.—Deflection ballistic errors introduced under the circumstances described in para-

graph 2 ordinarily are small and, were it not for the fact that another and more serious error is introduced in angular travel computation (for case II pointing) on the deflection board M1, they probably could be neglected. This error in angular travel computation results from reading a false time of flight value. (In the case of the universal deflection board, this consideration does not apply because angular travel computations are performed independently of the board for case II pointing. If desired, modification of the range or elevation scale of the ballistic chart can be accomplished in the same manner as described for the deflection board M1 in sections II and III of this appendix; however, such modifications usually can be regarded as unnecessary.)

■ 4. TIME OF FLIGHT ERRORS.—Since errors in determining time of flight values from the deflection board M1 are caused by using range or elevation readings which have been corrected for nonstandard ammunition or height of site, it follows that these errors, as well as deflection ballistic errors, can be eliminated by applying similar corrections to the range or elevation scale of the ballistic chart. Time of flight values should not be changed when modifying range or elevation scales.

■ 5. DESIRABILITY OF CORRECTING SCALES.—Errors in direction can be taken care of by adjustment of fire; however, it is desirable to have the first rounds fall as close to the target as possible. Methods employed in modifying range or elevation scales for deflection board M1 ballistic charts are explained in sections II and III.

SECTION II

MODIFICATION OF OLDER TYPE BALLISTIC CHARTS

■ 6. GENERAL.—The method of modification will depend on the way the chart was originally constructed. Generally speaking, the desired result is that the elevation (or range) scale used to position the chart will be so graduated that when the chart is positioned with the quadrant elevation (or range disk setting) opposite the elevation (range) index, the arc corresponding to the corrected range to the target (uncorrected for height of site) will be under the wind and drift pointer. The method of regraduating the elevation (or range) scale will depend on what scales are already on the chart.

■ 7. BATTERIES POINTING GUNS IN ELEVATION BY MEANS OF RANGE DISKS.—*a. Using standard ammunition.*—If the range disk is graduated for the same type ammunition as that being used, no correction is necessary (see par. 2b (1)).

b. Using nonstandard ammunition.—A range disk setting scale should be graduated on the ballistic chart, using the original range scale as a base and the percentage corrector tape (for the ammunition being used) as the source of data. The range corresponding to any range disk setting can be determined from the percentage corrector tape. The graduation on the new scale is then placed opposite the corresponding range graduation on the old scale. For example, if a range disk setting of 9,000 yards is opposite 9,120 yards on the logarithmic range scale of the percentage corrector tape, then the graduation for 9,000 yards on the new scale should be plotted opposite 9,120 yards on the original range scale. The graduations should be plotted in sufficient number to insure accuracy. Intermediate graduations can then be plotted by interpolation.

■ 8. BATTERIES POINTING GUNS IN ELEVATION BY MEANS OF ELEVATION QUADRANTS OR INDICATORS.—*a. Charts having both range and elevation scales.*—These charts are corrected for new heights of site by graduating a new firing elevation

(elevation sent to guns) scale. Each firing elevation graduation is plotted opposite the corresponding range, on the range scale. Corresponding ranges are determined from the percentage corrector tape as described in paragraph 7b. The old elevation scale (for zero height of site) may be bleached out if desired, to make room for the new scale.

b. Charts having elevation scale but no range scale.—

(1) The graduation of the new elevation scale on this type of chart requires the use of firing tables and some computation. The process is essentially the same as in *a* above except that there is no range scale to use as a base. The computations are not difficult but confusion may result if care is not taken to avoid it. The process consists of determining (from the percentage corrector tape) corresponding ranges for firing elevations (elevations sent to guns), converting these ranges into firing table elevations, and plotting firing elevations opposite corresponding firing table elevations on the elevation scale. This is best explained by an example.

Example: A battery of 6-inch guns M1900 firing shot AP Mk. XXXIII (FT 6-E-2) located at a height of site of 518 feet has a ballistic chart constructed for zero height of site. The chart has a uniform elevation scale along the right-hand side but no range scale. It is desired to construct a new elevation scale so that the chart will be correct for the height of site of the battery. The battery has a percentage corrector tape corrected for height of site.

(2) Prepare a table such as table I. In column 1, list the new graduations it is desired to locate. These may be taken 100 mils apart except at high and low elevations, where it may be necessary to plot every 50 mils or even every 10 mils for necessary accuracy. (This can be determined after the plotting has been started.) Turn the percentage corrector tape until each elevation in column 1 is under the index line and read the corresponding range from the logarithmic range scale. List these ranges in column 2. From table A of the firing tables, obtain the quadrant elevations corresponding to these ranges and list in column 3. On the original elevation scale locate the graduations listed

COAST ARTILLERY FIELD MANUAL

in column 3, and mark and label with values in column 1. Thus the 300-mil graduation on the new scale is found to be opposite the 309-mil graduation on the old scale. If, as will usually be the case, there is not room to plot the new scale on the chart, the scale distance of each new graduation will have to be computed and the old elevation scale will have to be bleached out before the new scale can be plotted. Mark the origin of the old scale by making a pinhole at the zero elevation mark. Measure the old scale to determine the number of mils per inch and compute the scale factor, that is, the inches per mil. Multiply each value in column 3 by the scale factor and list the results in column 4. Now bleach out the old scale, being careful not to spoil the time of flight scale. Locate the new graduations by laying off the distances given in column 4, measuring each distance from the pinhole marking the origin, and label with the values in column 1. Intermediate graduations may be interpolated.

TABLE I.—*Tabulation of problem in paragraph 8b (2)*

Scale factor $\frac{1}{80}$ inch = 1 mil

1 Firing quadrant elevation (mils)	2 Range (yards)	3 QE from firing table (mils)	4 Scale distance (inches)
100	11,120	115.8	1.45
200	15,560	211.0	2.64
300	18,800	309.0	3.86
400	21,460	408.1	5.10

SECTION III

ELEVATION-HEIGHT OF SITE GRID

■ 9. GENERAL.—From sections I and II it is seen that the elevation scale on the ballistic chart should be different for each height of site. In order to make it unnecessary to plot a special elevation scale for each battery, an elevation-height of site grid (see fig. 195) has been added to charts issued recently. A modified elevation index (see fig. 196) is also supplied to facilitate positioning the chart for any height of site within the limits of the grid.

■ 10. DESCRIPTION OF THE GRID.—The right-hand edge of the grid is the same as the older elevation scale for zero height of site. The left-hand edge is the elevation scale corrected for the maximum height of site for which the chart is constructed. Across the top and bottom of the grid are height of site scales. The curves are so plotted that a vertical line through any particular height of site graduation in the top or bottom scales will intersect the curves and give the proper elevation scale for that particular height of site. For fixed batteries, if the height of site is given, the Coast Artillery Board will issue these charts with the height of site line drawn in the proper position. For mobile batteries, the height of site line is omitted.

COAST ARTILLERY FIELD MANUAL

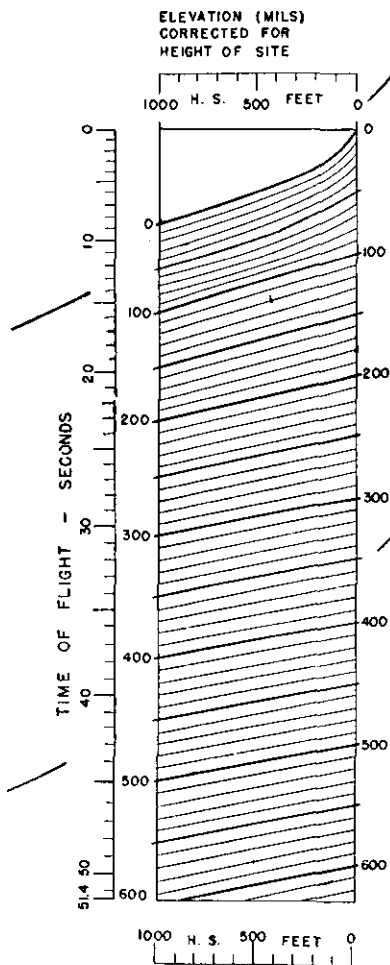

FIGURE 195.—Elevation-height of site grid, ballistic chart for deflection board M1.

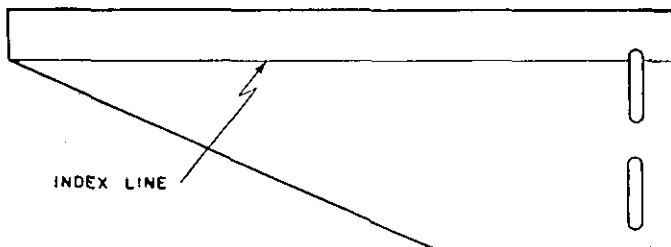

FIGURE 196.—Modified elevation index, deflection board M1.

■ 11. MODIFIED ELEVATION INDEX.—The modified index is made of xylonite. It is provided to replace the original metal index when the grid type chart is used. It should be positioned to read zero elevation at zero height of site when the ballistic chart is positioned with the zero elevation arc at the reading edge of the wind pointer. A small paper pointer may be pasted on the index to assist in setting to the proper elevation. To position the paper pointer, move the chart until the height of site scale is under the index line scribed on the xylonite and then paste the pointer so that the tip is on the index line and over the proper height of site graduation. When a mobile battery moves, it is necessary to reset the paper pointer to the new height of site.

■ 12. OPERATION.—Once the paper pointer has been positioned, the operation is exactly the same as described in section IV, chapter 12. Proper time of flight values appear under the horizontal line of the index when the chart is positioned for the elevation read from the percentage corrector.

COAST ARTILLERY FIELD MANUAL

[A.G. 300.7 (19 Jun 44).]

BY ORDER OF THE SECRETARY OF WAR:

G. C. MARSHALL,
Chief of Staff.

OFFICIAL:

J. A. ULIO,
Major General,
The Adjutant General.

DISTRIBUTION:

As prescribed in paragraph 9a, FM 21-6, except
D 4(5), CA Sch (200); B 4(5); R 4(5); Bn 4(5);
C 4(10); Def Comds (5); HD (5).

For explanation of symbols, see FM 21-6.

UNCLASSIFIED

FM 4-15

**COAST ARTILLERY
FIELD MANUAL**



**SEACOAST ARTILLERY
FIRE CONTROL AND POSITION
FINDING**



Dissemination of restricted matter.—The information contained in restricted documents and the essential characteristics of restricted material may be given to any person known to be in the service of the United States and to persons of undoubted loyalty and discretion who are cooperating in Government work, but will not be communicated to the public or to the press except by authorized military public relations agencies. (See also par. 186, AR 380-5, 28 Sep 1942.)

UNITED STATES
GOVERNMENT PRINTING OFFICE
WASHINGTON : 1943

UNCLASSIFIED

WAR DEPARTMENT,
WASHINGTON 25, D. C., 5 November 1943.

FM 4-15, Fire Control and Position Finding, is published for the information and guidance of all concerned.

[A. G. 300.7 (6 Sep 43).]

BY ORDER OF THE SECRETARY OF WAR:

G. C. MARSHALL,
Chief of Staff.

OFFICIAL:

J. A. ULIO,
Major General,
The Adjutant General.

DISTRIBUTION:

Bn and H4 (5) ; C 4 (10).

(For explanation of symbols see FM 21-6.)

TABLE OF CONTENTS

	Paragraphs	Page
CHAPTER 1. General.....	1-4	1
CHAPTER 2. Recognition and indication.....	5-9	2
CHAPTER 3. Fire control and position finding systems.		
SECTION I. General.....	10	6
II. Azimuth measurement.....	11-12	8
III. Tracking.....	13-19	9
CHAPTER 4. Firing data.....	20-24	15
CHAPTER 5. Displacement.		
SECTION I. General.....	25-27	20
II. Azimuth difference.....	28-31	21
III. Range difference.....	32-34	27
IV. Elevation difference.....	35-37	30
CHAPTER 6. Timing of position finding system.....	38-44	34
CHAPTER 7. Observation instruments.		
SECTION I. General.....	45	41
II. Azimuth instruments.....	46-47	41
III. Depression position finders.....	48-52	50
IV. Self-contained range finders.....	53-57	70
CHAPTER 8. Reference numbers.....	58-62	90
CHAPTER 9. Prediction and plotting board accessories.		
SECTION I. Prediction.....	63	94
II. Plotting board accessories.....	64-70	96
CHAPTER 10. Plotting boards.		
SECTION I. 110° plotting boards M1915 and M1918.....	71-73	107
II. Plotting boards M3 and M4.....	74-75	112
III. Plotting and relocating boards M1923 (Clove) and M1.....	76-79	121
CHAPTER 11. Range correction devices.		
SECTION I. General.....	80-81	138
II. Wind component indicator.....	82-84	143
III. Range correction board M1A1.....	85-88	147
IV. Other models of range correction boards.....	89-93	153
V. Percentage corrector M1.....	94-95	154
CHAPTER 12. Direction correction devices.		
SECTION I. General.....	96	161
II. Universal deflection board.....	97-100	162
III. Angular travel computer.....	101-102	169
IV. Deflection board M1.....	103-109	171
CHAPTER 13. Pointing methods and instruments.		
SECTION I. General.....	110-113	202
II. Pointing in elevation.....	114-123	203
III. Pointing in direction.....	124-137	219
CHAPTER 14. Spotting systems and devices.		
SECTION I. General.....	138-141	256
II. Spotting board M3.....	142-147	261
III. Other spotting boards.....	148-149	274
IV. Range rake.....	150	276

TABLE OF CONTENTS

	Paragraphs	Page
CHAPTER 15. Fire adjustment devices.		
SECTION I. Fire adjustment board M1.....	151-154	278
II. Bracketing adjustment chart.....	155-157	287
CHAPTER 16. Fire control system for 3-inch seacoast batteries.....	158-164	294
CHAPTER 17. Alternate methods.		
SECTION I. Principles of alternate fire con- trol methods.....	165	300
II. One-station fire control system.....	166-171	303
III. Modified one-station method using time-range board.....	172	315
IV. Central control.....	173-174	320
V. Gun commander's control.....	175-176	324
VI. Temporary and stand-by fire control system for 90-mm AMTB batteries.....	177-188	326
CHAPTER 18. Landward firing with seacoast armament.		
SECTION I. General.....	189-190	336
II. Fire control and position finding.....	191-194	337
III. Preparatory measures.....	195-199	340
CHAPTER 19. Gun data computer M1.		
SECTION I. General description and opera- tion.....	200-207	343
II. Typical horizontal base prob- lem.....	208-211	350
III. Summary.....	212-213	355
CHAPTER 20. Gun data computer M8.		
SECTION I. Description and operation.....	214-221	358
II. Theory.....	222-224	364
CHAPTER 21. Radio direction finding equip- ment (radar).....	225-228	367
CHAPTER 22. Organization and duties of range section and of other battery fire control personnel.		
SECTION I. Range section.....	229-231	370
II. Duties of range section details.....	232-234	373
III. Other battery fire control per- sonnel.....	235-237	380
IV. Training.....	238-245	381
CHAPTER 23. Functioning of fire control and position finding systems.		
SECTION I. General.....	246	386
II. Action before target is as- signed.....	247	388
III. Action when target is assigned.....	248-251	389
IV. Functioning when using other equipment.....	252-255	392
V. Functioning of spotting system.....	256	393
CHAPTER 24. Fire control and position finding for subcaliber practice.....	257-262	394
CHAPTER 25. Care and preservation.....	263-267	395
APPENDIX I. Glossary.....		399
II. Distances to horizon.....		411
III. Orientation of depression position finder in range on datum point above waterline.....		412

TABLE OF CONTENTS

	Page
IV. Maneuverability of naval vessels-----	414
V. Theory of displacement corrector, deflection board M1-----	422
VI. Construction of charts and scales for seacoast artillery fire control instruments-----	434
VII. Instructions for obtaining charts and scales for seacoast fire con- trol instruments from the Coast Artillery Board, Fort Monroe, Vir- ginia-----	460
VIII. Basic theory of spotting boards M2, M3, and M7-----	464
IX. Pointing 155-mm gun with artillery telescopes-----	467
X. Derivation of prediction for gun data computer M1-----	478
XI. List of references-----	488
INDEX-----	487

COAST ARTILLERY FIELD MANUAL

FIRE CONTROL AND POSITION FINDING

(This manual supersedes FM 4-15, 29 July 1940, and C 1, 5 May 1942.)

CHAPTER 1

GENERAL

■ 1. **PURPOSE.**—The purpose of this manual is to provide a guide for the technical training of the personnel employed in the determination and application of firing data for sea-coast artillery.

■ 2. **SCOPE.**—This manual, on the principles of fire control and position finding, includes the design and operation of all instruments and devices used by position finding and gun pointing details, and the functioning of these details as a whole. The contents of the manual apply to both fixed and mobile seacoast artillery. As soon as mobile artillery is emplaced in position for firing at naval targets, the principles of fire control and position finding, as laid down for fixed artillery, apply.

■ 3. **REFERENCES.**—More detailed information on fire control instruments and on related subjects may be found in the references listed in appendix XI.

■ 4. **DEFINITIONS.**—There are certain terms used throughout this manual, the meanings of which should be understood before beginning a study of the text. These appear in the glossary, appendix I, which should be read carefully before proceeding with the study of the manual.

CHAPTER 2

RECOGNITION AND INDICATION

■ 5. GENERAL.—Recognition, indication, and assignment of targets are of primary importance. Any system used must be simple, positive, and universal in its application, so that when a commander assigns a target there will be in the mind of the subordinate no doubt as to the target intended. A knowledge of the characteristics of each of the various types of vessels, both war and commercial, is necessary for their ready recognition by observers, gun pointers, and spotters. They may best be recognized at long range by their silhouettes—the outline of the solid features of the ship as seen at a distance. Silhouettes of warships may be found in pertinent standard publications, training films, film slides, and film strips. Silhouettes of all possible targets should be prepared and posted in the various stations of coast artillery commands. Silhouettes are often classified for convenience by using the number of funnels and masts as a basis; for example, class 1-2, where the first digit (1) indicates the number of funnels, and the second digit (2) the number of masts. (See fig. 1.)

■ 6. OBSERVER TRAINING.—Observers should be trained to recognize the different classes of naval vessels from their silhouettes. As aids in this training, charts showing silhouettes or outlines of both friendly and enemy naval vessels should be supplied to each observation station. In addition, posters of friendly and enemy aircraft, merchant vessels, and small craft should be provided.

■ 7. HARBOR DEFENSE WATER AREAS.—a. In order that targets may be indicated, it is necessary that the water areas adjacent to a harbor defense be subdivided. The method of accomplishing this subdivision will vary in different harbor defenses depending upon the geography and hydrography. A typical method is shown in figure 2. If the harbor defense shown included forts at one or more of the islands, each fort would make its own subdivision. The harbor defense



(1-0)



(1-0)



(1-1)



(1-2)



(1-2)



(2-1)



(2-2)



(2-2)



(3-1)



(3-2)



(4-1)



(4-2)

FIGURE 1.—Classification of ships for identification.

commander, in assigning a target from his command post to a groupment or group at one of these islands, would relocate and indicate the target with respect to the subdivisions of that fort.

b. (1) In assigning target A (fig. 2) to groups on Newton Point, the harbor defense commander would indicate it, TARGET, BEACH; in assigning target B, TARGET, TEAK. If there were more than one ship in the TEAK subarea it would be necessary to indicate the target more exactly. Thus, target B might be indicated TARGET, TEAK RIGHT, directing attention

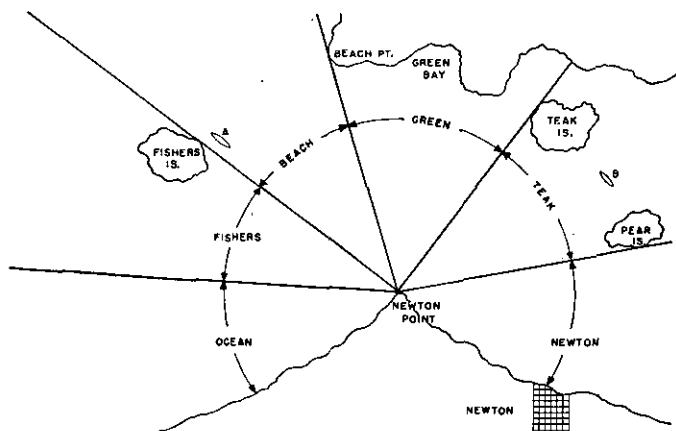

FIGURE 2.—Subdivision of harbor defense water area.

to a particular target toward the right limit of the TEAK subarea. The commander must be as definite as necessary in his indication of the target. Where there are several targets of the same type in the same subarea, the commander may give the approximate azimuth and range of the particular target, the target in this case being relocated so that the azimuth and range given will locate the target with reference to the station or battery to which assigned. Thus, target B might be indicated TARGET, TEAK RIGHT, AZIMUTH 232° , RANGE 18,000.

(2) Another method of relocating a target is by reference to an oriented grid which has been superimposed on a map

of a water area or subarea. In this system, large squares are lettered and subdivided into smaller squares which are numbered. The grid system has an advantage in that the target area can be readily located by all stations, thus reducing the confusion that might arise from observers having different points of view.

Typical target indications using such a system would be, TARGET, A14 and TARGET, B26.

■ 8. CONTENTS OF COMMANDS.—Commands employed in indicating and assigning a target to subordinate units should be as brief as the situation permits and leave no doubt as to their meaning. This will assure maximum speed in bringing effective fire on the target. For details concerning contents of seacoast artillery commands see FM 4-5 .

■ 9. OBSERVING AND AIMING POINT.—The observing and aiming point for observers, gun pointers, and spotters is some prominent feature of the target with which the vertical wire of the telescope can be readily alined. Unless otherwise designated by the officer assigning the target, the observing and aiming point is as follows:

- a. For vessels having funnels—leading funnel.
- b. For vessels having masts but no funnels—leading mast.
- c. For other vessels—the point designated by the officer assigning the target.

CHAPTER 3

FIRE CONTROL AND POSITION FINDING SYSTEMS

	Paragraphs
SECTION I. General.....	10
II. Azimuth measurement.....	11-12
III. Tracking.....	13-19

SECTION I

GENERAL

■ 10. GENERAL.—*a.* The function of a fire control and position finding system is to furnish data in the proper form for use in pointing the guns of a battery for firing at a target. In seacoast artillery, the guns must be pointed for firing at a moving target. The ideal system would furnish firing data instantaneously and continuously. With the present standard plotting room and data transmitting equipment, the operation is neither instantaneous nor continuous except where a gun data computer is used. There is a lapse of time between the instant an observation is taken on a target and the instant the guns are fired with the firing data that were calculated as a result of that observation. This interval between observation and firing is called the "dead time." Its length depends on the time necessary to calculate the firing data with the desired accuracy and apply them to the guns.

b. In a 3-inch rapid fire battery, case II pointing (par. 113*b*) is used. The ranges and times of flight are short and the dead time is negligible. The problem of determining firing data is comparatively simple. (Refer to ch. 16 on 3-inch guns.)

c. For a battery of 6-inch caliber or larger, the operation of determining firing data for a moving target is divided into the following steps:

(1) *Tracking.*—Includes observing and plotting successive positions of the target.

(2) *Location of set-forward point.*—Consists of determining the future position of the target, that is, its position at the end of the time of flight.

(3) *Relocation.*—Consists of determining the range and direction of the future position of the target (set-forward point) from the directing point.

(4) *Calculation of firing data.*—Consists of converting the relocated data into corrected firing data for use in pointing the guns.

d. Excessive dead time would afford the target undue opportunity to avoid the fire by maneuvering. On the other hand too short a dead time would not permit performance of the necessary operations with suitable accuracy. (See also par. 42d.)

e. The four standard systems of position finding in use by seacoast artillery are the horizontal base, vertical base, self-contained base systems, and radar. In all of these systems the procedure is similar. They differ only in the method of locating the target. At least two standard systems are usually made available for each battery. The standard systems may be supplemented by alternate systems consisting of different combinations of elements of the standard systems. The personnel of a battery should be trained and prepared to use all of the standard systems and alternate systems.

f. The correct operation of fire control equipment requires the proper and accurate orienting of instruments, plotting boards, and guns. In order to secure maximum efficiency in the harbor defense fire control system, it is essential that the data for the orientation of the equipment be complete and accurate and based on a uniform system throughout any one harbor defense. The first step in providing accurate orientation data is to provide a local plane projection which includes the stations and fields of fire of the harbor defense batteries. This projection should have negligible distortion and should facilitate the rapid and simple conversion of geographic coordinates to grid coordinates. Since the verniers on fixed gun azimuth circles were installed to read azimuths from true south, the map projection must be one that will not result in the grid south diverging from true

south by more than the one-degree adjustment provided in the vernier. The military grid coordinate system is based on a polyconic projection. In the majority of harbor defenses, the military grid system cannot be used because the divergence of grid south from true south exceeds 1° . The Lambert conformal conic projection has been used by the Coast and Geodetic Survey in mapping almost all harbor defenses because it has three important advantages—

(1) A high degree of accuracy is obtainable by the use of this projection over a limited area such as a harbor defense.

(2) The divergence when using a local grid system between grid south and true south is small.

(3) The conversion of geographic to grid coordinates and the computation to obtain the distance and azimuth between two points whose coordinates are known are comparatively simple. More detailed information will be found in TM 4-225.

SECTION II

AZIMUTH MEASUREMENT

■ 11. ANGULAR SYSTEM.—In all standard position finding systems, one of the elements of the data measured in locating the position of the target is called the "azimuth." Azimuth is the horizontal angle measured in a clockwise direction from a selected reference line passing through the position of the observer to the horizontal projection of the observer-objective line (line of sight from the observer to the objective; in this case, the target). For fixed seacoast artillery, the reference line is a horizontal line parallel to the true south line at the origin of the coordinates. (See TM 4-225.) Any instrument which will correctly measure horizontal angles will measure azimuths.

■ 12. ANGULAR UNITS.—The angular unit of measurement of all horizontal angles for all seacoast artillery, except as stated below for certain 155-mm guns, is the degree, an angle which is $\frac{1}{360}$ of a circle. Azimuths expressed in degrees ordinarily are measured to the nearest 0.01 of a degree. The angular unit of measurement of all horizontal angles for 155-mm guns which have not been modified to use the degree system

(see note) is the mil, an angle which is $\frac{1}{6400}$ of a circle. Thus, a degree is equal to 17.778 mils, and 9 degrees are equal to 160 mils. Azimuths expressed in mils are measured to the nearest mil. For practical purposes, in small angles, a mil may be taken as the angle which intercepts an arc (or chord) equal to $\frac{1}{1000}$ of the range; for example, at 10,000 yards, 1 mil intercepts approximately 10 yards.

NOTE.—As rapidly as possible, all sighting and other equipment for seacoast artillery using the mil as the azimuth unit will be replaced with new or modified equipment using degrees and hundredths.

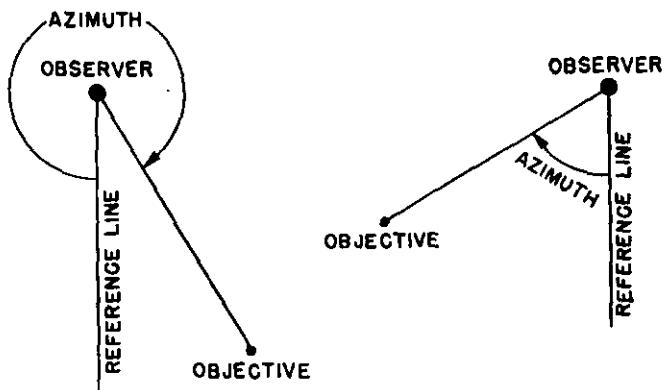

FIGURE 3.—Azimuth measurement.

SECTION III

TRACKING

(FOR BATTERIES NOT EQUIPPED WITH GUN DATA COMPUTERS)

■ 13. PRINCIPLES COMMON TO ALL SYSTEMS.—The first step in all position finding systems is locating the position of the target with respect to the observation stations of the battery. This operation, called "tracking," consists of locating at regular intervals of time, by observation from one or more stations, successive positions of the target and plotting those

positions on a plotting board. The time interval between successive observations is called the "observing interval" and is usually either 15 or 20 seconds in length. The observing intervals are indicated by TI (time interval) bells or buzzers which sound simultaneously in all stations of the battery.

■ 14. HORIZONTAL BASE SYSTEM.—*a. Description.*—(1) In the horizontal base system, the target is located by the method of intersection used in surveying in which the direction of the target from two known points is determined. In the triangle involved, one side and the two adjacent angles are known. The solution is arrived at graphically on the plotting board. The system requires a base line, the azimuth and length of which have been accurately determined by surveying (see TM 4-225); two observation stations, one at each end of the base line and each containing an instrument for measuring azimuths; a plotting board; and the necessary communication lines.

(2) The plotting board represents to scale the field of fire of the battery. On it are located in their proper relation to each other the observation (base-end) stations, and the directing point (the point for which the firing data are to be determined). Figure 4 illustrates the relation between the installations in the field and the set-up on the plotting board.

(3) The observation station nearer the directing point is usually called the primary station. The station at the other end of the base line is called the secondary station. The base line of a horizontal base system is called "right-handed" if the secondary station is to the right of the primary station, and "left-handed" if it is to the left, as viewed from behind the base line facing the field of fire.

(4) The base line for a horizontal base system should conform to the following principles:

(a) Its length should be from one-fourth to one-third of the maximum range of the battery it will serve.

(b) Its direction should be approximately perpendicular to the center line of the field of fire of the battery it will serve.

(c) The base-end stations should have sufficient height above sea level to afford a field of view to seaward beyond the maximum range to be measured. (See app. II.)

(d) The base line should be so located and of such length as to provide the maximum possible effective area in the field of fire of the battery. The effective area of the base line is the area containing only those positions of the target for which the intersection angle B^1-T-B^2 is greater than 15° and less than 165° .

(5) It is advantageous to use a shorter base line for sub-caliber practice as the ranges are smaller and therefore the intersection angle at the target is such that the location can be more accurately determined. For the same reason, the spotting base line should also be shorter.

b. *Operation.*—The observers at the base-end stations sight and follow with the vertical cross wires of their instruments the target assigned by the battery commander. At the sound of the signal to read, (see par. 39) the observers stop following the target with their instruments, while the readers read the azimuths. They then resume tracking. Each reader is equipped with a telephone head set, connecting him to an operator, called an arm setter, in the plotting room. There the successive observations are plotted on the plotting board. The plotting board has an arm for each of the two observation stations and each arm may be set in azimuth. Each arm setter sets his arm to the azimuth read by the corresponding reader. The point of intersection of the arms represents to scale the position of the target at the instant the observations were taken. This point is marked by the plotter. The operation is repeated at the sounding of each successive TI bell. The points are called "plotted points." A line joining the plotted points represents the track or path of the target.

■ 15. VERTICAL BASE SYSTEM.—a. *Description.*—In the vertical base system, the target is located by the offset method used in surveying, in which the direction and distance of the target from a known point are determined. The direction is determined by reading the azimuth as in the horizontal base system. The distance is determined by the depression angle method which involves the solution of a vertical right triangle of which one leg is the desired range, the other leg is the effective height of the observation instrument above the target, and the hypotenuse is the line of

sight from the observer to the target. The known angle is the complement of the angle between the hypotenuse and the

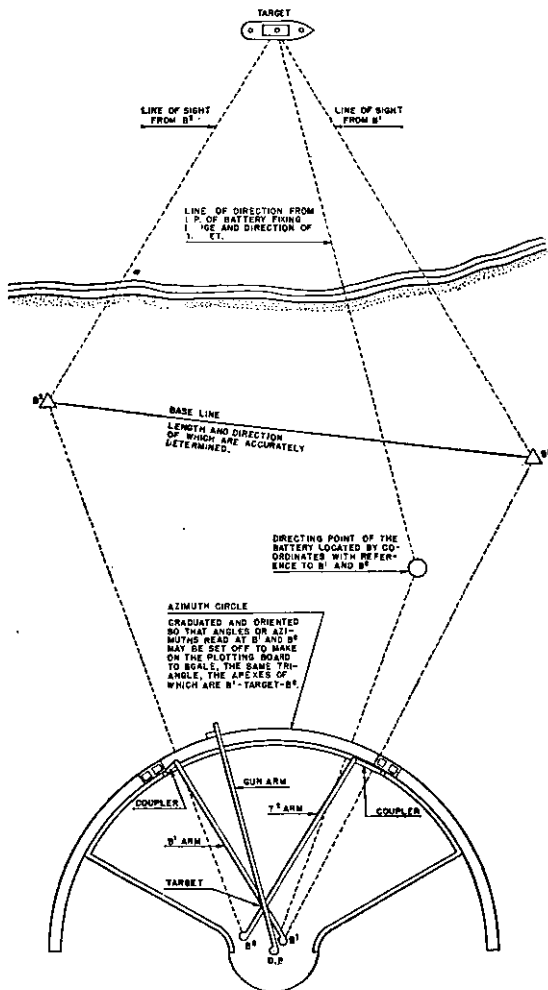

FIGURE 4.—Relation between plotting board and field of fire.

known side, corrected for refraction. It is the angle through which the line of sight must be depressed from the horizontal to intersect the target and is called the depression angle. The triangle is solved mechanically by the observation instrument called a "depression position finder." This system requires but one observation station, the azimuth and range to the target being read from the same instrument.

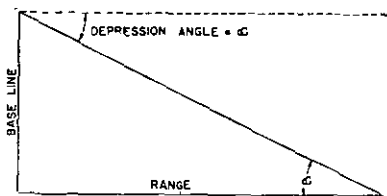

FIGURE 5.—Simple vertical base system.

b. Operation.—The observer tracks the target in azimuth with the vertical cross wire as in the horizontal base system. At the same time he tracks the target in range with the horizontal cross wire. In the plotting room, only one arm of the plotting board is used. The azimuth and range are received from the reader at each sounding of the TI bell. The arm setter sets the arm in azimuth and repeats the range to the plotter, who marks the point at that range by means of range graduations along the edge of the arm.

■ 16. SELF-CONTAINED BASE SYSTEM. *a. Description.*—In the self-contained base system, the target is located by the offset method as in the vertical base system. The direction is determined by reading the azimuth as in the other systems. The range is determined by means of a self-contained range finder of either the coincidence or stereoscopic type. For more on the principles of operation and accuracy limitations of these instruments, refer to chapter 7. (Also see FM 4-10.)

b. Operation.—The operation of tracking with this system is similar to that of the vertical base system except that azimuths are usually read from a separate instrument. Although it is more difficult to read ranges as the TI bell sounds in this system than in the vertical base system, observers can be trained to furnish ranges regularly on or sufficiently near the instant the TI bell sounds.

■ 17. RADAR.—When using radar, the target is located as explained in chapter 20 and the plotting board is used as for the self-contained base system.

■ 18. ALTERNATE BASE LINES AND ALTERNATE STATIONS.—For batteries employing the horizontal base system, several alternate base lines are frequently provided in order that use may be made of the base line allowing the greatest accuracy under existing conditions of visibility, target position, and target course. Figure 6 illustrates a set-up in which B^1-B^2 and B^1-B^3 are primary and alternate base lines, respectively, all stations of which are accurately located. Those stations of the horizontal base system which have sufficient height of site may be provided with depression position finders for use in a vertical base system, thus offering a choice of two systems.

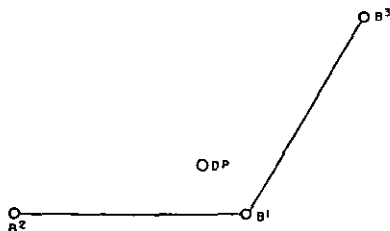

FIGURE 6.—Alternate base lines.

■ 19. ALTERNATE SYSTEMS. Alternate systems (ch. 17) possess features of reduced accuracy that are acceptable and are to be used only when all the standard systems break down or are put out of action. Possible methods include—

a. Use of data determined from a station outside the battery (either a group command station or the directing point of an adjacent battery), and their conversion to suitable firing data by means of range difference or azimuth difference charts.

b. Estimation of data from the guns by means of comparison with known ranges and azimuths of reference points, such as buoys in the field of fire, with subsequent adjustment as a result of observation of fire.

CHAPTER 4

FIRING DATA

■ 20. ELEMENTS OF UNCORRECTED FIRING DATA (fig. 7).—The set-forward point (see par. 63) having been located on the plotting board, a direction and a distance known as the "uncorrected firing data" must be determined for transformation into suitable data for the actual pointing of the gun.

a. It is obvious that a gun must be pointed in direction. This may be accomplished by either direct or indirect methods. If the target can be seen from the gun, the gun sight may be used. The sight may be pointed at the target and the gun set to diverge from the line of sight by the amount of the angular travel of the target during the time of flight. If the target cannot be seen from the gun, the gun is pointed in azimuth at the azimuth of the set-forward point and fired at the expiration of the dead time. In the first method, used in case I and in case II pointing, the desired element of the uncorrected firing data is the uncorrected deflection; in the second method, used in case III pointing, the desired element is the uncorrected azimuth. From figure 7 it may be seen that in both cases the gun is pointed in the same direction.

b. In addition to being pointed in direction, the gun must be pointed so that the projectile will fall at the desired distance from the gun. This may be done by varying the angular elevation of the gun and, since the horizontal may be readily established, the elevation is measured from the horizontal. This is called the "quadrant elevation." If the relation between the range and the quadrant elevation can be established, the range to the set-forward point may be used as the other element of the uncorrected firing data. Hence, the other element of the uncorrected firing data is the uncorrected range. It is the same for all cases of pointing.

■ 21. DETERMINATION OF UNCORRECTED FIRING DATA.—*a. Case III pointing.*—In case III pointing, the uncorrected range and the uncorrected azimuth may be read from the plotting board by bringing the gun arm up to the set-forward point.

b. Case II pointing.—In case II pointing, the uncorrected range, being the same as for case III, may be read from the plotting board as before. The uncorrected deflection is the angular travel of the target during the time of flight. To obtain it, there must be some means of determining the

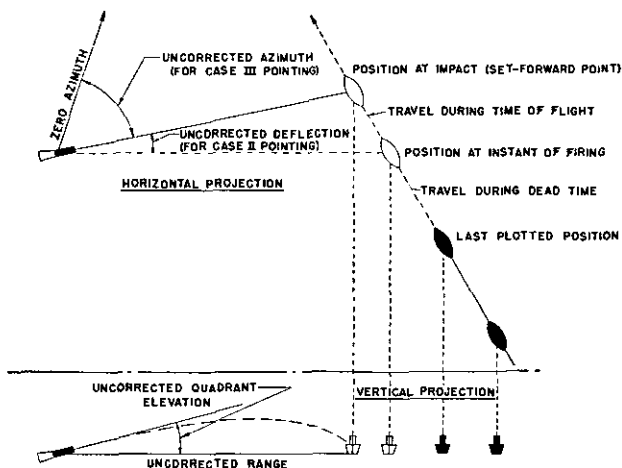

FIGURE 7.—Uncorrected firing data.

rate of angular travel of the target with respect to the directing point. That rate being known, it may be multiplied by the time of flight to the set-forward point. The range to the set-forward point having now been determined, the time of flight used in this operation is that corresponding to that range, as given in the firing tables. The rate of angular travel is determined from data obtained on the plotting board. The multiplication is performed graphically on either the deflection board or a special device called an angular travel computer. The functioning of these instruments is discussed in chapter 12.

■ 22. NECESSITY FOR CORRECTIONS FOR NONSTANDARD BALLISTIC CONDITIONS.—In order to compare the results of firings held at different times and places and take into account the conditions that actually exist at the time of firing, the range elevation relation is constructed for certain assumed ballistic conditions called "standard." Conditions at the battery at the time of a firing are very seldom exactly the same as those which are considered standard. Therefore it is necessary to consider and correct for those nonstandard conditions. To meet this problem, the firing tables include, in addition to the data for standard conditions, tables of differential effects by means of which necessary corrections may be made.

■ 23. CORRECTIONS TO RANGE.—*a.* Corrections to the range for the following nonstandard conditions are ordinarily made in the plotting room:

(1) Variations in muzzle velocity, including powder temperature effects.

(2) Variations in atmospheric density.

(3) Variations in atmospheric temperature (elasticity).

(4) Height of site, including tide. (See note below.)

(5) Wind.

(6) Rotation of the earth.

(7) Variations in weight of projectile.

b. These corrections are determined by a range correction board and are applied to the uncorrected range by an instrument called a "percentage corrector," the result being the firing range (or firing elevation) which is sent to the guns. Figure 8 (vertical projection) is a graphical representation of the application of corrections to the uncorrected range. Due to the various nonstandard conditions, it is necessary to elevate the gun to the elevation corresponding to the corrected range in order to hit the target which, in this example, is actually at a shorter range.

NOTE.—For fixed seacoast batteries in which each gun is laid in range by means of a range disk, the height of site of each gun above the datum plane (mean low water) is known, and the correction for this is incorporated in the graduations on the range disk on the gun. In such cases the correction for tide, however, is still made in the plotting room. For mobile artillery which is pointed in range by setting elevations and for guns equipped with an electrical data transmission system, the height of site correction is not made on the pointing equipment and therefore the correction for both height of site and tide must be made in the plotting room.

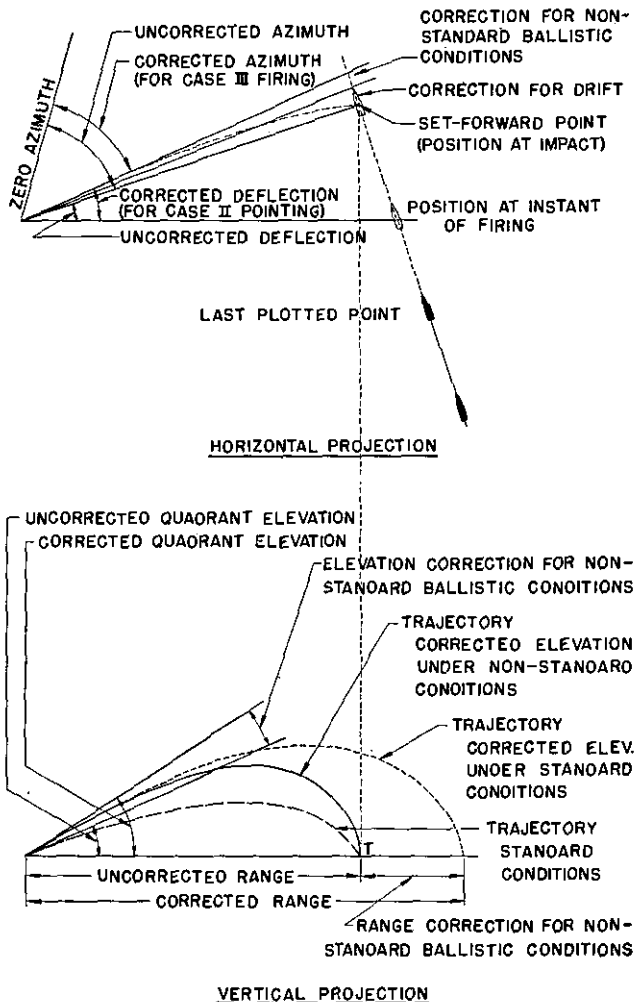

FIGURE 8.—Elements of corrected firing data.

■ 24. CORRECTIONS TO AZIMUTH OR DEFLECTION.—*a.* To the azimuth or to the deflection shown in figure 7, corrections for drift and for the following nonstandard conditions are ordinarily made in the plotting room:

(1) Wind.

(2) Rotation of the earth.

b. These corrections are determined and applied to the uncorrected azimuth or deflection by a deflection board, the result being the firing azimuth (or firing deflection) which is transmitted to the guns. Figure 8 (horizontal projection) shows a graphical representation of the application of these corrections to the uncorrected firing data.

CHAPTER 5

DISPLACEMENT

	Paragraphs
SECTION I. General	25-27
II. Azimuth difference	28-31
III. Range difference	32-34
IV. Elevation difference	35-37

SECTION I

GENERAL

■ 25. DEFINITIONS.—The following terms should be understood before proceeding with the study of this chapter:

- a. Relocation.
- b. Directing point (DP).
- c. Gun displacement.
- d. Gun parallax.
- e. Gun difference.
- f. Azimuth difference.
- g. Range difference.
- h. Elevation difference.

See glossary, appendix I, for pertinent definitions.

■ 26. RELOCATION.—In all the standard systems that employ the plotting board, relocation is performed mechanically on that instrument. It is accomplished by establishing the position of the directing point in the proper relation to that of the other points on the board and providing means for reading the azimuth and the range from the directing point to the target. However, it is sometimes necessary or desirable to relocate independent of the plotting board. Furthermore, it is often necessary, after having data referred to the directing point, to determine corrections to apply to these data in order to use them at other locations. These corrections to azimuth and range are known respectively as azimuth difference and range difference. The methods described in this chapter, sections II to IV, inclusive, are intended for use

in these latter cases. Since a plotting board is necessary when using a two-station system (except where data computers are used), relocation without the use of a plotting board would probably be confined to batteries using one-station systems.

■ 27. DIRECTING POINT.—*a. Two-gun batteries.*—In some of the older fixed two-gun batteries, the guns are fairly close together and the directing point has been taken as the point midway between the guns. The more modern batteries, however, have the guns spaced at a considerable distance so that it is necessary to make a displacement correction. In this case, No. 1 gun is usually taken as a directing point and a displacement correction is made for No. 2 gun.

b. Four-gun batteries.—In four-gun batteries, such as 155-mm batteries, the directing point may be taken halfway between No. 2 and No. 3 guns if all four guns are close together. The firing data computed for the directing point would be used on all four guns. If the 155-mm battery is dispersed by platoons, the directing point can be taken halfway between the two guns of one platoon and the firing data computed for the directing point would be used on the two guns of this platoon. A displaced point would be chosen halfway between the two guns of the other platoon and the firing data computed for the directing point would be corrected for the displacement of this point. These data would be used on the two guns of this other platoon. Or, any one of the four guns may be chosen as the directing point of the battery and the data computed for the directing point would be corrected for the displacement of each of the other guns. In this case, each gun would receive different firing data.

SECTION II

AZIMUTH DIFFERENCE

■ 28. APPROXIMATE FORMULAS.—These formulas may be used to determine an approximate value for azimuth difference when other means are not available. In situations similar to that shown in figure 9, where the triangle formed is

either right or isosceles, and for values of the parallax angle of less than 400 mils, the relationship is:

$$\text{parallax (degrees)} = 57 \frac{AB}{AT}$$

or

$$\text{parallax (mils)} = 1,000 \frac{AB}{AT}$$

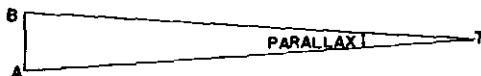

FIGURE 9.—Parallax diagram for approximate formulas.

■ 29. GENERAL FORMULA.—For practical purposes the formula below is satisfactory for general use. In figure 10, A is a point from which the range and azimuth to T are known. It is desired to find the parallax angle p , having given the azimuth of AB and the displacement d . Thus:

$$\frac{\sin p}{AB} = \frac{\sin BAT}{BT}$$

But

$$AT = BT \text{ (approximately)}$$

Therefore

$$\sin p = \frac{AB \sin BAT}{AT}$$

Angle BAT is obtained from the known azimuths of AT and AB .

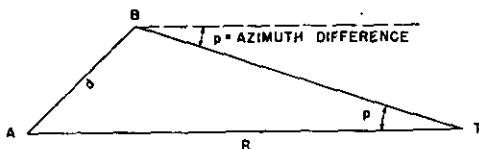

FIGURE 10.—Parallax diagram for general formula.

■ 30. AZIMUTH DIFFERENCE CHART.—*a. General.*—The chart in figure 11 is actually a graphical solution of the general formula given in paragraph 29. It consists of equally spaced

horizontal lines labeled in azimuth differences within an azimuth circle, and a rotating arm, graduated in a particular manner, with ranges. The device is operated simply by setting the movable arm to the azimuth of the target and reading the azimuth difference from the horizontal line opposite the range.

b. *Example.*—Construct a graphical chart for the determination of azimuth differences for point *B* when the ranges and azimuths to the target from point *A* are known, and the field of fire is from 90° to 290° . The azimuth from *A* to *B*

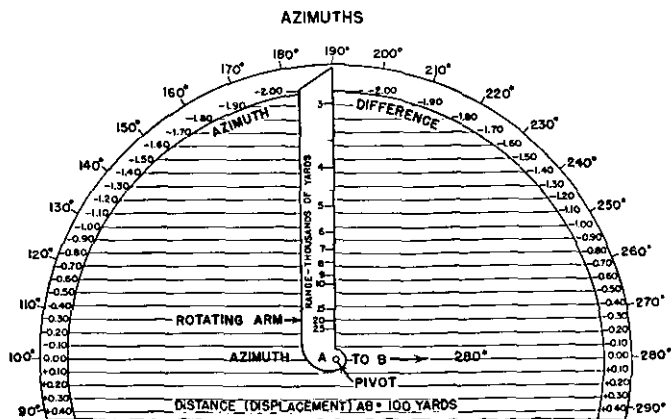

FIGURE 11.—Azimuth difference chart.

is 280° , and the distance *AB* is 100 yards. Since at any particular azimuth the azimuth difference increases as the range decreases, the size of the chart required may be limited by selecting, as the minimum range to be covered, a range as great as practicable. For this example the minimum range is assumed to be 3,000 yards.

In figure 11 the horizontal lines are drawn first. Any convenient uniform spacing is used. There must be a sufficient number of lines to accommodate the maximum azimuth difference. Since the azimuth difference for a given range is a maximum when the angle *BAT* is 90° , the number of lines required is determined by a solution of the general formula,

using that value of the angle and the value of the minimum range already selected. This solution follows:

$$\sin p = \frac{AB \sin BAT}{AT}$$

$$\sin p = \frac{100 \sin 90^\circ}{3000}$$

$$\sin p = 0.03333$$

$$p = 1.91^\circ$$

Therefore

In figure 11 the horizontal lines are spaced at intervals, each representing 0.10° of azimuth difference. Lines up to 2.00° will be sufficient in this case. In practice the lines would be spaced at intervals representing 0.05° . To determine

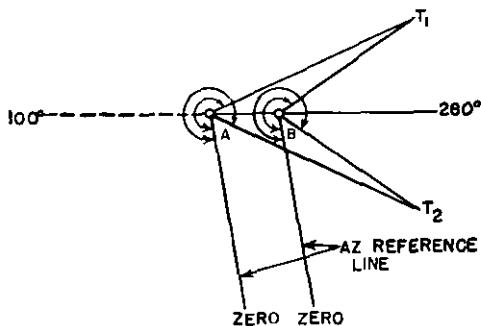

FIGURE 12.—Determination of sign of azimuth differences.

which azimuth differences are plus and which are minus, a simple sketch should be made. For the example given, figure 12 shows the situation. From this figure it can be seen that the azimuth of BT_1 is less than the azimuth of AT_1 , and the azimuth of BT_2 is greater than the azimuth of AT_2 . Thus, in computing the azimuth of B, it can be seen that for targets below AB (target azimuths between 280° and 100°), all azimuth differences will be positive and should be added to the azimuth of AT; and for targets above AB (target azimuths between 100° and 280°), all azimuth differences are negative and should be subtracted from the azimuth of AT. The azimuth circle is next drawn and graduated. It will be noted that the azimuth difference will be zero for all ranges

when the target is in prolongation of the line *AB*, which occurs at azimuths of 280° and 100° . The 280° graduation, therefore, is placed on the azimuth circle on the right side of the chart in prolongation of the line *AB*. Other graduations are placed by means of a protractor. In the figure, graduations are placed and marked 10° apart. Intermediate graduations may be added as desired. In order to place range graduations on the rotating arm, it should be rotated to a point where the angle *BAT* is 90° . Target azimuth 190° is such a point. In this case the general parallax formula in paragraph 29 takes the form:

$$\sin p = \frac{d}{\text{range}} \quad (\text{where } d = \text{displacement})$$

since $\sin \text{BAT}$ is unity. From this formula the following table is prepared for use in graduating the rotating arm:

Range	<i>d</i> /range	<i>p</i> in degrees	Range	<i>d</i> /range	<i>p</i> in degrees
3,000	0.0333	1.91	8,000	0.0125	0.72
3,500	.0286	1.64	9,000	.0111	.63
4,000	.0250	1.43	10,000	.0100	.57
4,500	.0222	1.27	15,000	.0067	.38
5,000	.0200	1.15	20,000	.0050	.29
6,000	.0167	.96	25,000	.0040	.23
7,000	.0143	.82			

The rotating arm is constructed to solve azimuth difference when the line *AB* and the line *AT* are perpendicular to each other. For any other azimuth the rotating arm graphically multiplies the range by the sine of the angle between the line *AB* and the line *AT* and therefore solves completely the general parallax formula.

■ 31. APPLICATION OF AZIMUTH DIFFERENCE.—If the guns are pointed by means of a deflection (cases I and II), each gun sight, with proper deflection setting applied, is directed at the target. Therefore, no correction for displacement is made to the deflection. If guns are pointed by means of an azimuth, it may be necessary to apply an azimuth difference correction due to displacement. It is desirable that guns

be pointed in direction with accuracy sufficient to insure that the lateral error caused by errors in pointing does not exceed 10 yards or 0.03° . For any particular value of angular error, the lateral deviation is directly proportional to the range. The following table shows the ranges at which the small errors in pointing will cause a lateral deviation of 10 yards:

Errors in pointing (degrees)	Range (yards)	Errors in pointing (degrees)	Range (yards)
0.01	57,296	0.04	14,324
.02	28,648	.05	11,459
.03	19,099	.06	9,549

If the guns are close to the directing point it may be possible to obtain the required accuracy for all service ranges by pointing the guns parallel to each other without correction. Where the field of fire is narrow, sufficient accuracy may be obtained by causing the guns to converge at a central point in the field of fire when all are set with the azimuth from the directing point to the central point. The methods of adjusting guns to converge or to fire parallel to each other are discussed in chapter 13. When parallax is so large that a mean correction will not suffice, the usual method is to make the parallax correction in the plotting room and then send separate azimuths to the individual guns. The deflection board M1 is equipped with a displacement corrector so that azimuths may be determined for two separate points. There is also a scale on this instrument where the value of the parallax correction can be read. In the absence of instruments of the required type, an azimuth difference chart must be used to make parallax corrections. The transmitter of the data transmission system M5 has means of applying parallax corrections.

SECTION III

RANGE DIFFERENCE

■ 32. FORMULA.—In figure 13 the range difference from points *A* and *B* is calculated for point *T*. Angle *BAT* can be obtained from the known azimuths of *AB* and *AT*.

$$AX = d \cos BAT \quad (\text{where } d = \text{displacement}) \quad (1)$$

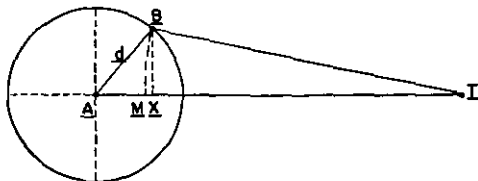

FIGURE 13.—Range difference.

Actually, the range difference is *AM*, which is obtained by swinging an arc from *B* with *T* as a center. For all practical purposes $AX = AM$ and equation (1) may be written:

$$\text{range difference} = d \cos BAT \quad (2) \quad \checkmark$$

It can be seen from the formula that range difference is not considered to be affected by changes in range but only by changes in azimuth to the target.

■ 33. RANGE DIFFERENCE CHART.—*a. General.*—A range difference chart (fig. 14) is actually a graphical arrangement of the solution by formula. The chart consists of an azimuth circle with an auxiliary scale showing the range difference opposite the corresponding azimuths.

b. Example.—Construct a chart of range differences from a point *B* to *T* when the range and azimuth from *A* to *T* are known. The azimuth from *A* to *B* is 60° and the displacement is 100 yards. Show the values of range difference to the nearest 10 yards. (A maximum range difference of 100 yards will be used until the actual difference becomes smaller than 95 yards, when a value of 90 yards will be used until the actual value becomes less than 85 yards, when 80 yards will be used, and so on.) In order to locate the points where a

change takes place, construct a table from the formula in equation (2) (par. 32), which can be rewritten as follows:

$$\cos BAT = \frac{\text{range difference}}{d}$$

1	2	3	4			
Range difference (yards)	Cos <i>BAT</i>	Angle <i>BAT</i> (degrees)	Azimuths			
100	1.00	0	60		240	
95	.95	18	42	78	222	258
85	.85	32	28	92	208	272
75	.75	41	19	101	199	281
65	.65	49	11	109	191	289
55	.55	57	3	117	183	297
45	.45	63	357	123	177	303
35	.35	70	350	130	170	310
25	.25	76	344	136	164	316
15	.15	81	339	141	159	321
5	.05	87	333	147	153	327
0	.00	90	330	150	150	330

The angles shown in column 3 are taken to the nearest degree. The values of the angles apply to each quadrant. The range differences, however, are positive for two quadrants and negative for the other two. The foundation of the chart in figure 14 is based on the azimuth circle of figure 13. The example gives the displacement as 100 yards and the azimuth from *A* to *B* as 60°. The maximum range differences are then at target azimuths of 60° and of 240°. The former range difference is -100 yards and the latter is +100 yards. According to the table, 100 yards is the range difference until the target azimuth changes 18° on either side of the 60° and 240° graduations. Marks are, therefore, drawn at 60±18 and 240±18, or at target azimuths of 78, 42, 258, and 222. The next marks are at 60±32 and 240±32 or at 92, 28, 272, and 208 for a difference of 90 yards. Other marks are located in similar manner from data obtained in column 4. Zero

range differences are at target azimuths 150 and 330. Tabulating these data in table form aids in the construction of the range difference chart.

■ 34. APPLICATION OF RANGE DIFFERENCE.—When the displacement is small, the gun difference (range difference) is negligible. Due to nature of the terrain, the size of the guns, or the need for protection, the guns of a battery might some-

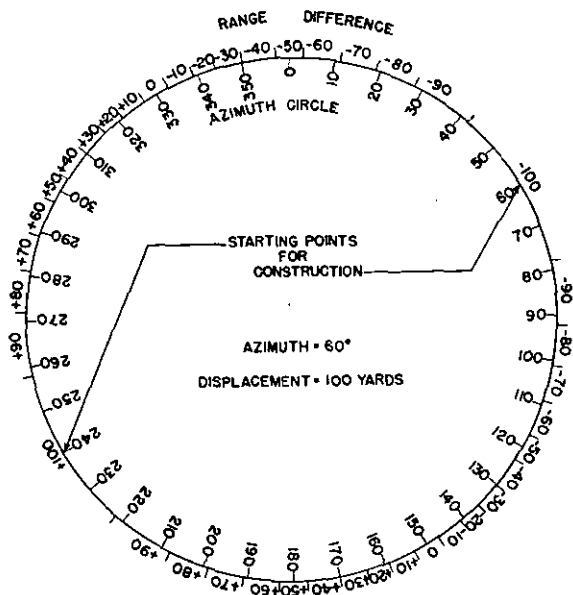

FIGURE 14.—Range difference chart.

times be widely separated, in which case corrections should be made for gun differences. When ranges are set in yards by means of range disks, the corrections may be made either in the plotting room or at the guns. The range may be furnished for each individual gun by determining the range difference from a range difference chart. In this case, the correction is applied in the plotting room. When corrections in yards are made at the guns, an arrow is painted on the edge of the rotating platform so that it can be seen

from the elevating handwheel. This arrow is used as an index to a scale painted on the emplacement, touching and concentric with the gun platform. The scale is a range difference chart. The correction indicated on the scale by the arrow, when the gun is pointed in azimuth, is applied to the range received from the plotting room before it is set on the range disk. If the guns are laid in elevation in angular units, corrections must be applied by means of an elevation difference chart.

SECTION IV

ELEVATION DIFFERENCE

■ 35. GENERAL.—The solution of elevation difference requires the use of firing tables or of a chart based on the firing tables. The general formula for range difference (see par. 32 and fig. 13) is:

$$\text{range difference} = d \cos BAT \quad (\text{where } d = \text{displacement})$$

If d in the equation is changed into elevation at the range under consideration, the resulting equation produces the elevation difference for that particular range. While range difference for all practical purposes is affected by changes in azimuth only, elevation difference is, in general, affected both by changes in range and by changes in azimuth. An examination of firing tables will prove that a change in range of 100 yards at a range of 15,000 yards requires an elevation change different from that required for an equal change at a range of 5,000 yards.

■ 36. ELEVATION DIFFERENCE CHART.—*a. General.*—The elevation difference chart (fig. 15) consists of an azimuth circle with a rotating arm, graduated in range and pivoted at the center of the circle. To operate the device, the arm is turned to the azimuth of the target, and the elevation difference is read on that vertical line which is opposite the range.

b. Example.—Construct a chart of elevation differences in mills for a 16-inch gun M1919, using 2,100-pound AP projectile and full charge (Firing Tables 16-B-1), low angle fire only, up to a range of 44,300 yards.

NOTE.—Above 44,300 yards the range is approaching the maximum. At this point the change in elevation corresponding to a change of 100 yards in range is very large and is not shown accurately in the firing tables.

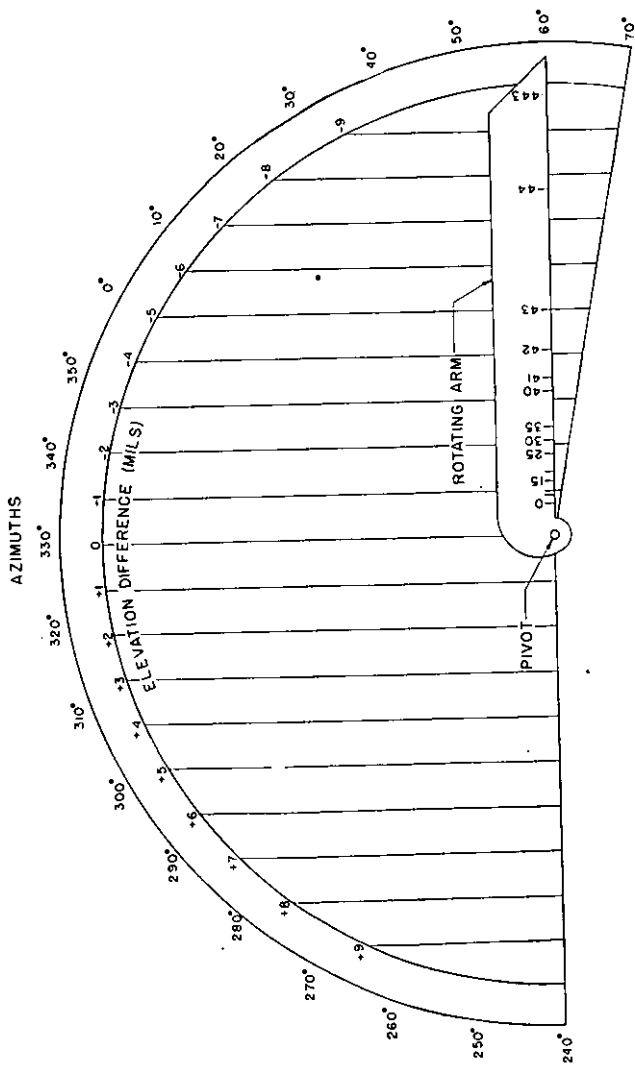

FIGURE 15.—Elevation difference chart.

The azimuth from the directing point to the offset gun is 60° and its displacement is 110 yards. The field of fire of this gun is from 240° through 360° to 70° azimuth. An azimuth circle of any convenient radius is constructed first, placing 60° , the azimuth to the offset gun, opposite the horizontal radius (fig. 15). Next, the vertical lines are drawn. They are equally spaced and must be sufficient in number to accommodate the maximum elevation difference. The maximum elevation difference in this case will be for a gun difference of 110 yards at 44,300 yards range (Firing Tables 16-B-1 show for 100 yards 8.9 mils) which is 9.8 mils. By visualizing this example and referring to paragraph 32 (including fig. 13), and to paragraph 33 (including the table), it can be seen that all values of elevation difference to the right of the vertical line through the pivot are negative and those to the left are positive. The rotating arm is graduated in range to produce the proper elevation difference where the gun difference is a maximum (that is, where it is equal to the displacement, which is 110 yards), in this case at target azimuth 60° . The following table shows the data to be used in graduating the rotating arm. It shows in column 3 the

1	2	3
Range (yards)	Change in elevation (mils) for change in range of 100 yards	Change in elevation (mils) for change in range of 110 yards
0	0.6	0.7
5,000	.8	.9
10,000	.9	1.0
15,000	1.1	1.2
20,000	1.3	1.4
25,000	1.6	1.8
30,000	1.9	2.1
35,000	2.2	2.4
40,000	2.9	3.2
41,000	3.2	3.5
42,000	3.7	4.1
43,000	4.5	5.0
44,000	7.0	7.7
44,300	8.9	9.8

elevation difference corresponding to a range change of 110 yards at each of the ranges shown in column 1.

To locate the graduations on the rotating arm, the arm is set at azimuth 60° or 240° . Each graduation for ranges indicated in column 1 in the table can now be placed on the arm so that it coincides with the proper elevation difference graduation (listed in column 3) as indicated by the vertical lines on the chart. For example, the zero range graduation (elevation difference= 0.7 mils) is placed on the arm at a point seven-tenths of the distance from the zero vertical line to the 1-mil vertical line, and the 30,000-yard range graduation (elevation difference= 2.1 mils) is placed at one-tenth the distance from the 2-mil vertical line to the 3-mil vertical line. Since, from the general formula:

$$\text{range difference} = d \cos BAT$$

It follows that, with the rotating arm graduated to solve the elevation difference for the distance d , rotation of the arm to another azimuth will multiply graphically by $\cos BAT$ (see fig. 13), thereby giving a general solution for elevation difference.

NOTE.—If more than one kind of ammunition (including sub-caliber) is to be used, the vertical lines should be sufficient in number to accommodate the ammunition with the greatest elevation difference so that when ammunition is changed it will be necessary to change only the rotating arm on the chart.

■ 37. APPLICATION OF ELEVATION DIFFERENCE.—When ranges are set in terms of angular units, as quadrant elevations, the corrections are determined by means of an elevation difference chart (fig. 15) in the plotting room, and the elevation is sent to each gun. The transmitter of the data transmission system M5 has a dial for the application of elevation difference corrections to the individual guns.

CHAPTER 6

TIMING OF POSITION FINDING SYSTEM

■ 38. GENERAL.—Since most targets engaged by seacoast artillery are moving targets, it is essential that a position finding system be designed for such targets. With the exception of systems using the gun data computers which give continuous and instantaneous data, observations by azimuth instruments give the position of the target only at the time of observation. Since there is an appreciable time between the observation of data and the firing of the guns, it is necessary that data be obtained for definite instants of time. Because of this, a timing system for position finding must be used in order to establish regular instants of observation and firing. This chapter discusses the relationship between timing and position finding systems.

■ 39. TIME INTERVAL BELLS.—*a.* Time interval bells (TI bells) furnish the basis for timing in position finding and fire control systems. A suitable time interval is chosen (see par. 41); for example, 20 seconds. Each 20-second interval is denoted by the sounding of a bell or buzzer.

b.—There are two systems of time interval bells. One system has three consecutive bells sounding on the last 3 seconds. The other system sounds four bells, one 5 seconds before the end of the interval and the other three on the last 3 seconds, consecutively. In either case, all but the last bell of each system are warning bells. The final bell of one time interval is exactly 20 seconds apart from the final TI bell of the next interval. When TI bell is mentioned hereafter in this discussion, it refers to the final TI bell of the series.

c. Bells or buzzers sound simultaneously in all stations of the battery, in the plotting room, and at the gun position. In fixed installations, bells are normally utilized in all elements of the battery installation. In mobile batteries, bells or buzzers are utilized in the plotting room and stations. In some instances, the sound of the buzzer is superimposed on

the reader's telephone line for distant observation stations to avoid laying a long separate line for the TI system. In mobile batteries a howler, rather than a bell, is normally used at the gun position.

■ 40. OPERATIONS AFFECTING TIMING.—a. With the present system of position finding and calculation of firing data, the supply of data is not continuous except when a gun data computer is used. The position of the target at each 15- or 20-second interval is plotted, and the firing data calculated from a given observation are correct only for the instant for which calculated. Therefore coordination is necessary between the operation of calculating firing data and the operations of loading, pointing, and firing the gun.

b. Since the firing data are correct only for a given instant, the instant of firing the gun must be determined, and firing data must be calculated for that instant; or data must be calculated for use at some future time and the gun must be fired at the predetermined instant. TI bells serve as a basis for this coordination. The operations necessary in the process of preparation of firing data, and the firing of the guns using that data are:

- (1) Observation on the target and transmission of the observed data to the plotting room.
- (2) Plotting of the observed position of the target.
- (3) Location of the set-forward point.
- (4) Relocation.
- (5) Calculation of corrected firing data.
- (6) Transmission of those data to the guns.
- (7) Restoration of the guns to the loading position (after firing of the preceding round).
- (8) Loading the guns.
- (9) Pointing the guns.
- (10) Firing the guns.

NOTE.—See discussion of flow of data in chapter 22.

c. Some of these operations take place concurrently, while some cannot be performed until certain others have been completed. The first four steps are all performed on the plotting board. The first six steps are consecutive. The first five steps are performed in the plotting room, and the

sixth step consists of telephoning or otherwise communicating the firing data to the gun position. With a well-trained range section the first six operations can conveniently be performed in 15 to 20 seconds. After the first six steps are completed, the pointing and firing of the guns then fall in order. Restoration of the guns to loading position and loading of the guns (steps 7 and 8) may be performed during computation of firing data in the plotting room. However, the last two steps, pointing and firing the guns, cannot be performed until firing data are available at the gun position. The time required for the pointing and firing of the guns is dependent upon the type and the caliber of the gun and the efficiency of the gun section.

d. Because observations are taken at chosen intervals of time, the operations in the plotting room must be repeated periodically with new data. New firing data are transmitted periodically to the guns.

■ 41. TIME INTERVALS.—The time between the instant the observation is made and the instant the data leave the plotting board is generally longer than the time taken to get data from the plotting board to the gun position. Therefore, the time interval between observations should be so chosen that an observation can be made and the data on that observation cleared through the plotting board before the sounding of the next TI bell. This interval between successive observations on the target is called the observing interval. During the observing interval the set-forward point is located on the plotting board, relocation takes place, firing data are calculated, and those data are transmitted to the guns. With the higher speeds and greater maneuverability of modern ships and the increased times of flight due to longer ranges of newer guns, the necessity for keeping the length of the observing and predicting intervals at a minimum assumes added importance. An observing interval of 15 or 20 seconds (indicated by the time interval bell), and a predicting interval of equal length will usually fulfill all conditions satisfactorily. Normally the observing interval should not exceed 20 seconds. In a 155-mm gun battery, the observing interval may be 15 or 20 seconds. In case II

firing, a 15-second observing interval is recommended. In case III, a 20-second observing interval is recommended.

■ 42. CHOICE OF OBSERVING INTERVAL.—*a.* The choice of an observing interval is dependent upon a number of factors. It is dependent on the time required for the observed data to clear the plotting board. If 18 seconds are required between the instant of observations on the target and the delivery of relocated data from the plotting board, it would be useless to choose a 15-second observing interval. In determining the length of time required for data to clear the plotting board, the possible sustained rate of clearing data rather than an occasional maximum rate must be considered. The firing interval of the guns, that is, the time between successive firings of the gun, is also a factor in choosing the observing interval. Since observation should be made on the bell and the gun fired on the bell, the firing interval should be equal to or be some multiple of the observing interval. The firing interval must also be chosen with a view to sustained operation under actual service conditions. The maximum length of the firing interval is limited only by the tactical situation, but the minimum length of the firing interval for case III operation is limited by the observing interval. For case II pointing, the firing interval may be less than the observing interval when the interpolator on the percentage corrector is used. In any event, firing data must be furnished for the minimum firing interval.

b. Normal rates of fire for target practice for each type of armament are prescribed in TM 4-235. However, it should be remembered that the effectiveness of the battery is measured in hits-per-gun-per-minute. Therefore, firing should be conducted at the maximum rate which can be sustained with accuracy. Battery commanders should strive through training to increase the rates of fire of their batteries to exceed the acceptable minimum rates.

c. As examples in the choice of a time interval assume that in the 155-mm battery, data can be cleared from the plotting board in 13 seconds at a sustained rate and that the firing interval of the guns is 15 seconds. In this case the TI bells would be put on a 15-second basis and a 15-second observing

interval would be utilized. Data would be available for the guns to fire upon any 15-second TI bell. On the other hand, in the case of a major caliber battery, the data might be cleared from the plotting board in 13 seconds, but the firing interval of the gun is 40 seconds. In this case, a 20-second time interval would be chosen. Firing data would go to the guns on each 20-second bell for firing on the next bell.

d. Another consideration is dead time. (See app. I.) It is the interval required for observation and transmission of the observed data to the plotting room, calculation of firing data in the plotting room, transmission of firing data to the guns, and the pointing and firing of the guns. The dead time in any particular battery can be determined only by timing the progress of the data through the various elements in the battery. Dead time is usually assumed as a multiple of the time interval. For example, if the dead time in a particular battery is found actually to be 18 seconds, and the battery is operating on a 15-second time interval system, the dead time is assumed to be 30 seconds. When more than one combination of observing and firing intervals is possible, the combination selected should be the one which will give the shortest dead time.

■ 43. FURNISHING DATA.—Data may be transmitted to the guns on or before each TI bell so that after each bell has sounded there will be available at the gun emplacement fresh data for firing on the next bell. Some battery commanders prefer to have the data sent to the guns immediately following the TI bell. This avoids confusion as to which bell the data on the board applies. Firing data should be available for each TI bell irrespective of the length of the firing interval. Then, if a gun has a firing interval of 45 seconds and for any reason is unable to fire on the proper bell, it may be fired on the next 15-second bell instead of waiting for the following firing interval.

■ 44. EXAMPLES.—In the following example, flow of data from the observation stations to the guns is represented by the stepped line in the upper portion of the diagram (fig. 16). The positions O_1 , O_2 , O_3 , O_4 , and O_5 represent the TI bells upon

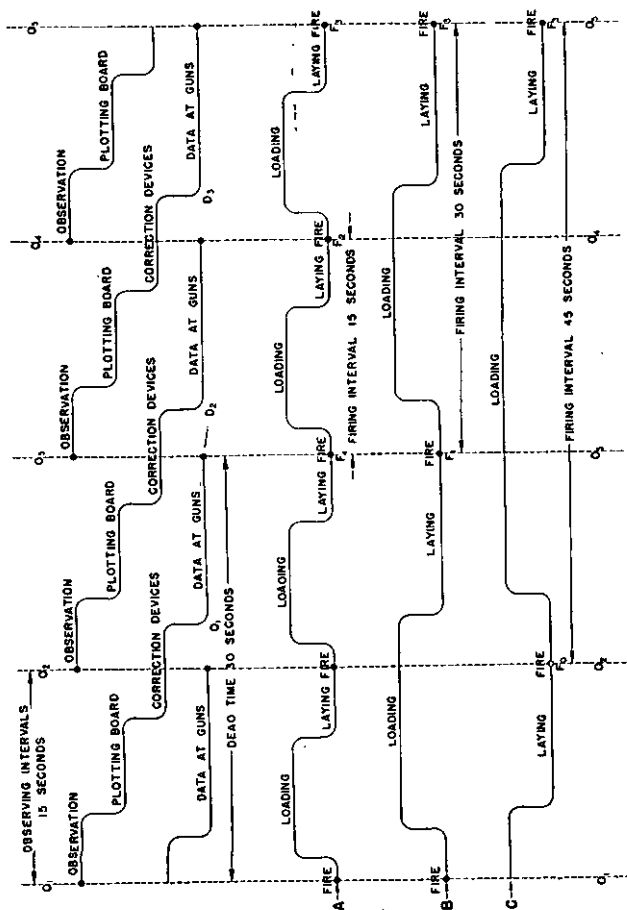

FIGURE 16.—Timing of position finding system.

which observations are made at 15-second intervals and the horizontal distance between successive observations represents 15 seconds. By following the stepped line starting from O_1 , it will be seen that the data obtained on this observation are still going through the correction devices at the instant O_2 when the next observation is started. The O_1 data do not reach the guns until some time after time O_2 . Likewise, the data started from O_2 will not arrive at the guns until some time after TI bell O_3 . From the above, it can be seen that if the gun is to be fired on TI bell O_3 , it must be laid with data obtained from observation on O_1 giving a dead time of 30 seconds. The horizontal distances along each step indicate approximately the time consumed in each step, while the points marked D_1, D_2, D_3 indicate the time the data arrive at the gun. If the firing interval is 15 seconds, the loading and firing cycle can be indicated by the wavy line marked A and the gun will be fired on each set of data received. In this case, the gun will be fired on TI bell O_3 on data based on observation made on TI bell O_1 . This is indicated as F_1 . Similarly, the gun is fired on TI bell O_1 on data obtained by observation taken on O_2 . This is indicated as F_2 . If the firing interval is 30 seconds, represented by line B , and the gun is fired (F_1) on TI bell O_3 on data obtained from the observation taken on O_1 , the gun cannot be fired again until TI bell O_5 , by which time the data from observation taken on TI bell O_3 have reached the guns. In this case, the data from observation on O_2 would not be used. In a similar manner, it can be shown that if a firing interval is 45 seconds, the gun will be fired on the data from every third observation as shown on line C .

CHAPTER 7

OBSERVATION INSTRUMENTS

	Paragraphs
SECTION I. General	45
II. Azimuth instruments.....	46-47
III. Depression position finders.....	48-52
IV. Self-contained range finders.....	53-57

SECTION I

GENERAL

■ 45. CLASSIFICATION.—Observation instruments used in position finding are classed as azimuth instruments, depression position finders, and self-contained range finders. An azimuth instrument is an instrument used for the purpose of measuring horizontal angles (usually azimuths). Some models are also equipped for measuring small vertical angles. Instruments of this class are principally for use with the horizontal base system. In addition, they are used with the self-contained base system. (See sec. IV.) A depression position finder (D. P. F.) is an instrument used for measuring ranges by the depression angle method and for measuring horizontal angles (usually azimuths). Instruments of this class are for use primarily with the vertical base system. They may be used also with the horizontal base system in lieu of an azimuth instrument. A self-contained range finder is an instrument used for measuring ranges by direct observation. There are two types of instruments, the coincidence type and the stereoscopic type. The self-contained range finder is furnished for use with rapid-fire batteries.

NOTE.—For a complete discussion on the accuracy to be expected from the various types of observation instruments, see FM 4-10.

SECTION II

AZIMUTH INSTRUMENTS

■ 46. AZIMUTH INSTRUMENT M1910A (DEGREES) (fig. 17).—*a. Description.*—This instrument is furnished to seacoast

artillery for use in measuring horizontal angles. It is not designed to measure vertical angles.

(1) The telescope contains an optical system consisting of an objective lens, Porro erecting prisms, and eyepiece. Two eyepieces are furnished, one giving 10-power and one giving 15-power magnification. A reticle is inserted in the system ahead of the eyepiece with provisions for moving the reticle into the plane in which the image is cast. The reticle consists of a piece of glass on which are etched a vertical line, which serves as the vertical cross wire, and a splash scale

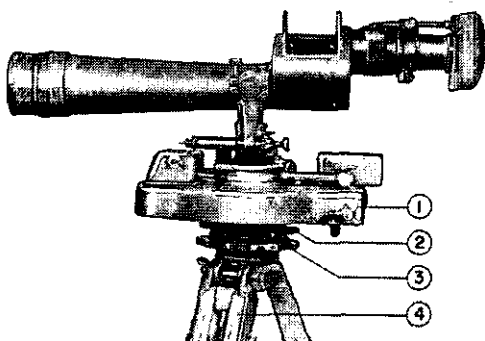

1. Base.

2. Leveling screws.

3. Leveling plate.

4. Tripod, type A.

FIGURE 17.—Azimuth instrument M1910A1 (degrees).

which is in position as the horizontal cross wire. The scale is graduated in degrees from 1.6° on the right to 4.4° on the left with a least graduation of 0.02° and with 3° as the normal (or zero deviation). (See pars. 58 and 59.) The splash scale is for use when the instrument is employed for spotting. (See ch. 14.) It is provided with a movable pointer called a "splash pointer." If the cross wires intersect the target at the instant of splash, and if the pointer is moved independently to the center of the splash, the scale indicates in reference numbers the angular correction as viewed from that station. Some older models of this instrument, and those designated as M1910, have the splash scale on a trans-

parent piece of celluloid in the lower part of the field. The least graduation on the splash scale of this older model is $.05^\circ$.

(2) The base provides means of holding the telescope, of imparting to it motion in vertical and horizontal planes, and of measuring the horizontal movement. Its principal parts are the yoke, the traversing mechanism, the azimuth scale

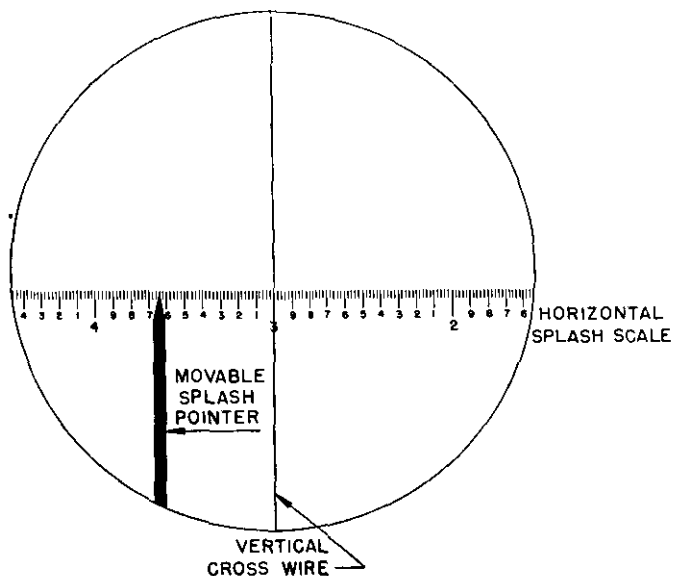
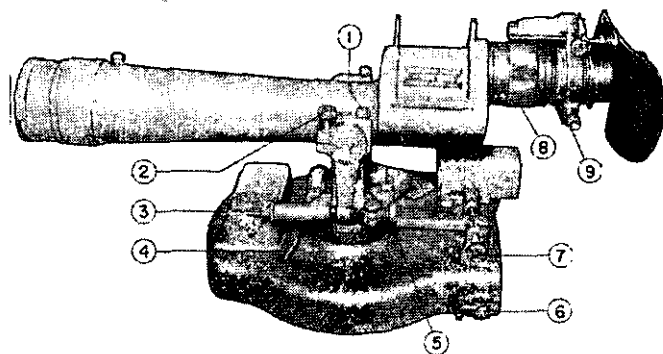

FIGURE 18.—Splash scale, azimuth instrument M1910A1.

micrometer is graduated in hundredths of a degree. When and micrometer, and the leveling mechanism. The telescope is supported by bearings in the yoke, allowing about 40° of movement in a vertical plane, although scales are not provided for measuring vertical angles. The instrument is traversed in slow motion by operating the azimuth worm crank, which turns the housing relative to the worm gear. The worm may be disengaged to allow fast traversing by hand and reengaged without disturbing the orientation of the instrument. The azimuth scale is graduated in degrees; the



- | | |
|--|-------------------------------------|
| 1. Yoke cap clamping screw. | 6. Throw-out lever. |
| 2. Depression clamping screw. | 7. Azimuth slow-motion thumb-screw. |
| 3. Adjusting screw knob. | 8. Focusing nut. |
| 4. Azimuth clamping screw. | 9. Lead screw. |
| 5. Depression slow-motion thumb-screw. | |

FIGURE 19.—Azimuth instrument M1910A1—left side.

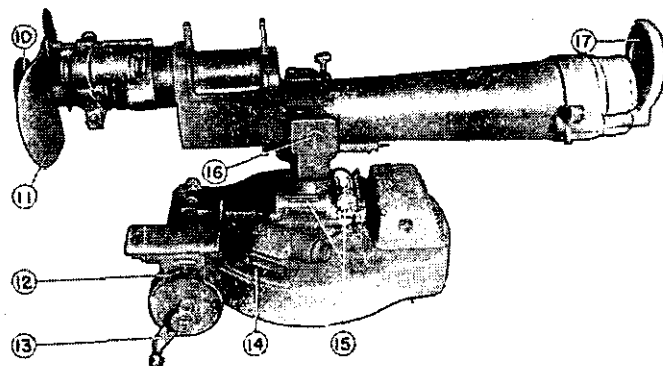

- | | |
|-------------------------|---------------------------|
| 10. Eyepiece. | 14. Azimuth scale window. |
| 11. Mask (eye shade). | 15. Levels. |
| 12. Micrometer. | 16. Yoke. |
| 13. Azimuth worm crank. | 17. Objective shutter. |

FIGURE 20.—Azimuth instrument M1910A1—right side.

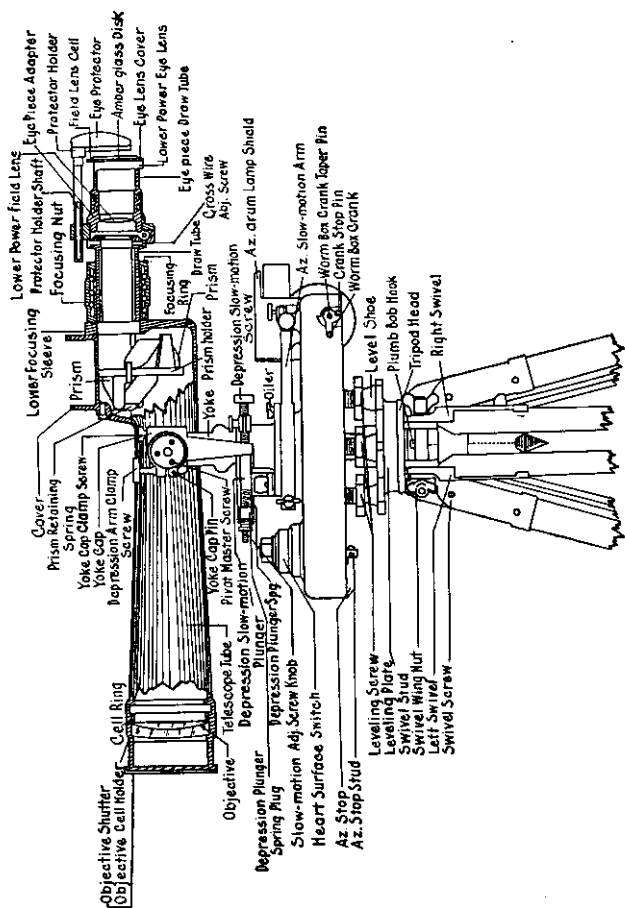

FIGURE 21.—Azimuth instrument M1910A1—detailed drawing.

micrometer is graduated in hundredths of a degree. When orienting provision is made for traversing the telescope and yoke independent of the housing. For convenience in operation, however, the eyepiece end of the telescope should be slightly to the left of the azimuth worm crank. The leveling mechanism consists of a leveling plate, four leveling screws, and two level vials.

(3) The tripod consists of a tripod head and three adjustable legs. The base screws onto the tripod head. Pier mounts, consisting of tripod heads on concrete or steel supports, are usually provided in permanent base-end stations of fixed seacoast artillery.

b. Adjustment and orientation.—The steps in adjustment and orientation of this instrument consist of locating the instrument exactly over the point representing the base-end station, leveling the instrument, focusing the eyepiece, removing parallax by properly focusing the objective lens, and making the instrument read the correct azimuth of a point when sighted on that point. The complete operation of setting up, adjusting, and orienting is as follows:

(1) *Locating.*—Set up the tripod and adjust it to the proper height. Suspend the plumb bob from the center of the tripod. Place the tripod so that the plumb bob will be centered over the station marker and that the tripod head will be approximately level. Attach the base and mount the telescope in the yoke. When using the pier mount, the operation of locating the instrument is accomplished by mounting it on the mount provided.

(2) *Approximate orientation.*—Set the azimuth index and subscale to read the azimuth of a datum point visible from the station. If the eyepiece is not approximately to the rear of the azimuth slow-motion arm, loosen the azimuth clamping screw, swing the telescope to its proper position, and tighten the azimuth clamping screw. Using the azimuth slow-motion thumbscrew, adjust the azimuth slow-motion arm to the approximate center of its lateral movement. Loosen all four leveling screws and, without turning the tripod, rotate the upper part of the mount relative to the leveling plate until the telescope points approximately at the datum point, taking care not to score the leveling plate or unscrew it from the tripod head. In setting up the M1910

instrument, an older model, this method of approximate orientation is not possible because one of the leveling shoes is attached to the leveling plate. Therefore, the entire tripod must be rotated until the telescope is pointed approximately at the datum point. Otherwise, the operation is the same.

(3) *Leveling*.—(a) See that all four leveling screws have a uniform and *moderately* firm bearing on the leveling plate. Release the traversing worm by rotating the throw-out lever and traverse the instrument until one of the levels is parallel to two diagonally opposite leveling screws. Turn these screws by turning thumbs simultaneously either toward or away from each other until the bubble of that level is centered. The bubble will follow the direction of motion of the left thumb. Without traversing the instrument, center the bubble of the other level by means of the two remaining leveling screws, readjusting each bubble for any error caused by centering the other.

Caution: In turning the leveling screws, maintain the uniformly moderate bearing of all screws on the plate; if the screws bind, loosen one screw and proceed with the operation. Binding of the screws will bend the spindle and make correct leveling of the instrument impossible in the future.

(b) Traverse the instrument through 180° and check the level. If a bubble departs from the center, correct one-half of the variation by the appropriate level adjusting screw at the end of the level vial holder. Relevel the instrument and check by rotating 180° and again note the position of the bubbles. Repeat the complete operation until the level bubbles remain centered for any position of the telescope in azimuth.

(4) *Focusing eyepiece*.—This operation consists of screwing the eyepiece in or out to bring out most distinctly the roughness of the cross wires. It should be done with the telescope pointed toward the sky. This adjustment will be constant for a given observer.

(5) *Focusing objective and removal of parallax*.—Direct the telescope at the datum point and move the objective lens in or out by means of the focusing nut until there is no parallax of the cross wires; that is, no apparent movement of the

cross wires across the image of the datum point as the eye is moved across the eyepiece. The cause of parallax is the lack of coincidence between the focal plane of the objective lens and the plane of the reticle. It is often impossible to remove parallax completely from both the vertical and the horizontal cross wires. In azimuth instruments, the complete parallax adjustment should be made for the vertical cross wire. This adjustment will be constant for a given instrument. As there is always a possibility that the eyepiece is not focused exactly on the cross wires, it is very important that the objective lens be focused to eliminate parallax, as previously described. If this results in a blurred image, the eyepiece should be used to bring the image into sharp focus. This eyepiece adjustment will depend upon the vision of the observer who makes the adjustment. If used by another observer, he should adjust the instrument for clearness of vision by focusing the eyepiece and not the objective.

(6) *Exact orientation.*—After all previously mentioned adjustments have been made, reset the instrument to the azimuth of the datum point, loosen the azimuth clamping screw, and bring the vertical cross wire of the telescope approximately on the datum point. Tighten the azimuth clamping screw and, using the azimuth slow-motion thumbscrew, bring the vertical cross wire exactly on the datum point. Clamp the azimuth slow-motion thumbscrew. Check all adjustments and reorient if necessary. If possible, the orientation should be checked on at least one other datum point.

c. Operation.—The instrument is operated by one man, an observer, who is assisted by a reader during tracking. The observer receives by telephone the command assigning the target. He directs the vertical cross wire of his instrument on the target and reports, "On target." At the command **TRACK**, he tracks the target, keeping the vertical cross wire on the designated observing point by turning the azimuth worm crank. At the intervals indicated by the **TI** bell, he stops tracking momentarily to permit the reader to transmit the azimuth to the plotting room.

■ 47. **AZIMUTH INSTRUMENT M1918 (mils).**—*a.* At present this instrument may be furnished for use with 155-mm guns.

(See note, par. 12.) It is similar to the M1910A1 instrument. The main differences are—

(1) The telescope is smaller and lighter.

(2) The powers of the two eyepieces furnished are 10 and 20 instead of 10 and 15.

(3) The instrument is equipped to measure vertical angles from -300 mils to $+500$ mils. (The elevation scale has 10-mil divisions; the elevation micrometer, 0.2-mil divisions.)

(4) The azimuth scale is graduated in 10-mil divisions and the azimuth micrometer is graduated in 0.1-mil divisions.

(5) The telescope reticle has a horizontal cross wire. The splash scale is a considerable distance below the horizontal cross wire and is graduated in mils in both directions from the center. (See fig. 23.)

b. The adjustment, orientation, and operation are the same

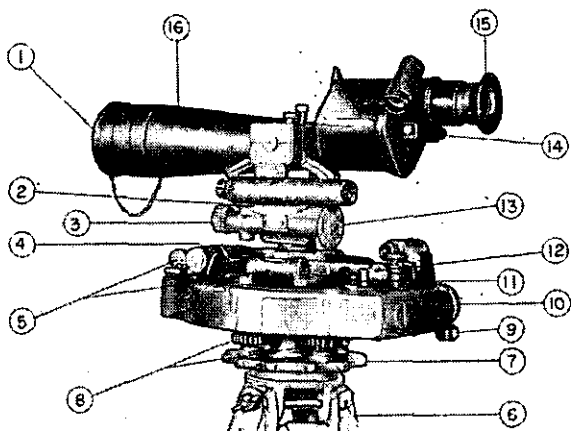

- | | |
|-------------------------|-------------------------------------|
| 1. Objective cap. | 10. Azimuth micrometer. |
| 2. Elevation scale. | 11. Throw-out lever. |
| 3. Elevating worm knob. | 12. Azimuth slow-motion thumbscrew. |
| 4. Rheostat. | 13. Elevation micrometer. |
| 5. Levels. | 14. Lead screw. |
| 6. Tripod, type H. | 15. Eyepiece. |
| 7. Leveling plate. | 16. Telescope. |
| 8. Leveling screws. | |
| 9. Azimuth worm crank. | |

FIGURE 22.—Azimuth instrument M1918 (mils).

as for the M1910A1 instrument except that there is no provision for eliminating parallax, since the telescope is of the fixed focus type.

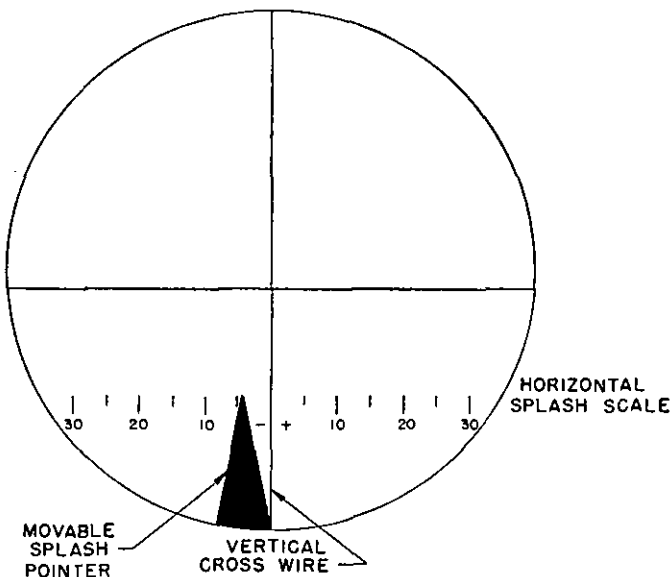

FIGURE 23.—Splash scale, azimuth instrument M1918.

SECTION III

DEPRESSION POSITION FINDERS

■ 48. RANGE FINDING BY DEPRESSION ANGLE METHOD.—*a.* The method of range finding by means of the depression angle is used by depression position finders employed in the vertical base position finding system. By this method the range to the target is determined by measuring the angle at the instrument between the horizontal and the line from the instrument to the waterline of the target, and by indicating on a graduated scale the product of the cotangent of that angle and the height of the instrument above the

target. In this method the effect of the curvature of the earth must be considered. The problem is illustrated in figure 24, where O represents the position of the observer at a height OM above sea level, the arc MT represents the surface of the sea, and T the position of the target on the sea. By sighting on the target the angle d is measured. This angle combined with the true height OM will give a range MP , whereas the desired range is NT ($=MT'$). This range could be computed by using a corrected depression

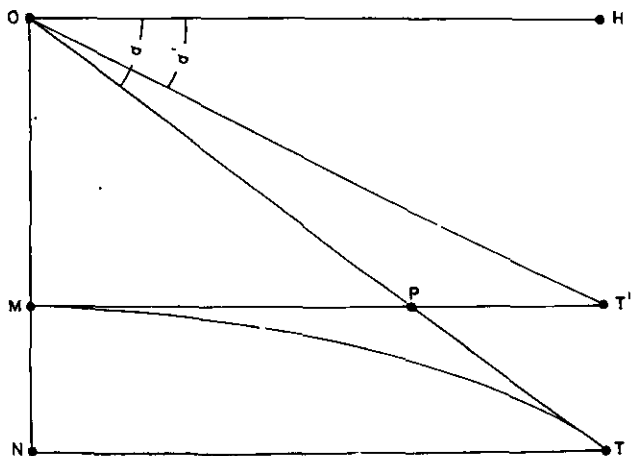

FIGURE 24.—Effect of curvature of earth on line of sight.

angle d' or by using a corrected height of instrument ON . The latter method is used in seacoast artillery instruments. The instruments are designed to correct for curvature of the earth, without appreciable error, at all values of the depression angle.

b. The problem is further complicated by atmospheric refraction. As the rays of light pass from the target to the observer, they are bent downward so that the apparent change in the height of instrument due to curvature of the earth is less than the true change. The effect of refraction is illustrated in figure 25 which is similar to figure 24.

Because of refraction, a ray of light from the target will reach the observer by the curved path TO and the target will appear to be on the line OR . As in the case of curvature alone, the desired range is the range NT but the proper height of instrument is the height OP . The amount of refraction is extremely variable, and the variations from normal can be detected only by checking the instrument on two datum points, one of long and one of short range.

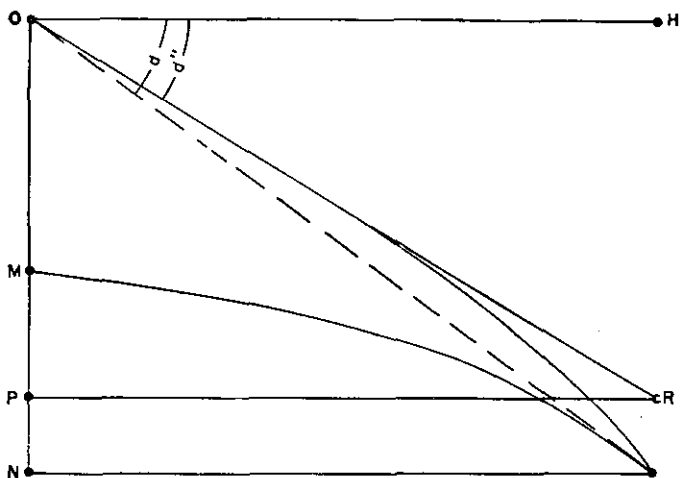

FIGURE 25.—Effect of atmospheric refraction on line of sight.

c. Corrections for curvature of the earth and for normal refraction are made on the instruments by graduating the range disks for the corrected height of instrument OP (fig. 25). Provision is made on all instruments to compensate automatically for changes in the effect of curvature and normal refraction due to changes in range. Small changes in the height of instrument due to tide and changes in refraction from normal may be corrected for without appreciable error. These adjustments are discussed in detail in the paragraphs dealing with the separate instruments.

■ 49. SWASEY DEPRESSION POSITION FINDER (fig. 26).—*a. Description.*—The Swasey D. P. F. is an instrument equipped to measure horizontal angles and to measure ranges by the depression angle. It may, therefore, be used in either a horizontal or a vertical base system. (See par. 45.)

(1) The telescope contains an optical system similar to that of the azimuth instrument but with a larger field and more illumination. Eyepieces are furnished for 12- and 20-

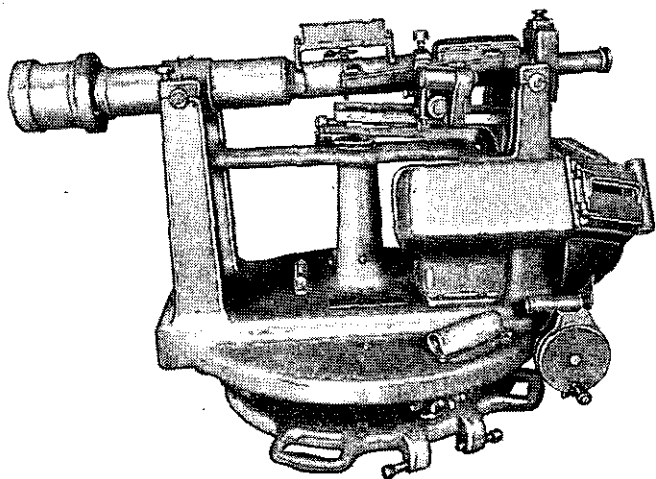

FIGURE 26.—Swasey depression position finder.

power magnifications. A vertical wire and a horizontal wire are carried in a slide in the micrometer box, allowing vertical motion of the slide. The instrument does not have an interior splash scale.

(2) The cradle provides means of supporting the telescope, of imparting to it motion in vertical and horizontal planes, and of making the adjustments necessary to permit reading correct azimuths and ranges. The traversing mechanism is similar to that of an azimuth instrument. The azimuth scale is graduated in degrees; the azimuth micrometer is graduated in hundredths of a degree. The range drum is

graduated to indicate every 10 yards of range between 1,500 and 12,000 yards. The leveling mechanism is similar to that of an azimuth instrument.

(3) The base is a heavy metal casting which supports the cradle and telescope.

b. Adjustment and orientation.—The steps in adjustment and orientation of this instrument consist of leveling, focusing the eye-piece, focusing the objective lens to remove parallax, checking the range drum for telescope level, adjusting the range for curvature of the earth, refraction, and tide, and making the instrument read the correct azimuth of a point when sighted on that point. Small adjustments in azimuth may be made by means of the azimuth setscrews. Large adjustments in azimuth can be made only by unbolting the pedestal from the floor and rotating the entire assembly until the telescope is pointing at the datum point or close enough to it so that the difference can be taken up by the azimuth setscrews. With this exception the adjustments are similar to those outlined in paragraph 51*b* for the depression position finder M1907. The additional adjustments not discussed in that paragraph are as follows:

(1) *Telescope level.*—After the instrument is leveled, the range crank should be rotated until the level on the top of the telescope indicates that the telescope is horizontal. The range disk reading should then be TELESCOPE LEVEL. If it is not, loosen the screws attaching the range drum, to the bevel gear and, holding the telescope horizontal, rotate the range drum until it reads TELESCOPE LEVEL. Tighten the holding screws. The bubble of the level should then remain stationary while the height slide is moved to any position.

(2) *Range adjustment.*—After the check for telescope level, the range adjustment may be made. As the first step, set the height slide so that the reading on the height scale is that of the instrument corrected for the tide. Select two datum points, D_L at a range somewhat longer and D_s at a range somewhat shorter than the ranges over which it is expected to work. Using the range crank, set the range drum at the reading of D_L and direct the telescope at that datum point; bring the horizontal cross wire to the water line of that datum point by means of the micrometer screw,

located above and just forward of the eyepiece. Using the range crank, set the range drum at the reading of D_s and direct the telescope at this datum point. Next, bring the horizontal cross wire all the way to the water line of this datum point by means of the height slide pinion. Repeat these two operations until correct readings on both D_L and D_s can be obtained by operating only the azimuth drum handle and the range crank. This adjustment should be repeated at intervals, the frequency depending on the extent of the variation in tide and refraction.

c. Operation.—The instrument is operated by one man, an observer, assisted by a reader. For the vertical base system, the observer tracks the target, keeping the vertical cross wire on the designated observing point by turning the azimuth drum handle, and the horizontal cross wire on the water line of the target by turning the range crank. At the intervals indicated by the TI bell, he stops tracking momentarily to permit the reader to transmit, first, the azimuth and, second, the range to the plotting room. For the horizontal base system the target is tracked in azimuth only.

■ 50. THE ERDMAN COMPENSATOR.—The Swasey depression position finder is so designed that it can be used only for a specific height of site with some adjustment possible to allow for changes of tide. Obviously, this will make it necessary to have each instrument especially calibrated for the location at which it is to be used. To avoid this inconvenience, a compensating mechanism, known as the Erdman compensator, is included in two other depression position finders, M1907 and M1 (to be described in pars. 51 and 52), to allow operation over a limited range of heights of site. The range scale for these instruments is graduated for a height of site intermediate between the maximum and minimum height of site for which these instruments are designed. The compensating mechanism, however, is introduced to permit the use of the same range scale for different heights of site above and below that for which the range scale was calibrated. This compensator makes use of a cam to introduce correction.

Example (see fig. 27) : Let D represent the position of an observer at a height DO above sea level and B the position of an object on the surface of the sea which is shown by the arc, OB , of a circle. The horizontal range to be determined is BK . Due to the refraction of the atmosphere, a ray of light leaving B will reach D by the curved path, BD . A tangent, DC , drawn to this curve at D gives the range to be determined, BK as now represented by the side, CG , of the right-angled triangle, DCG . Let us call the effective height of site b , and the necessary range R , and the angle of depression α .

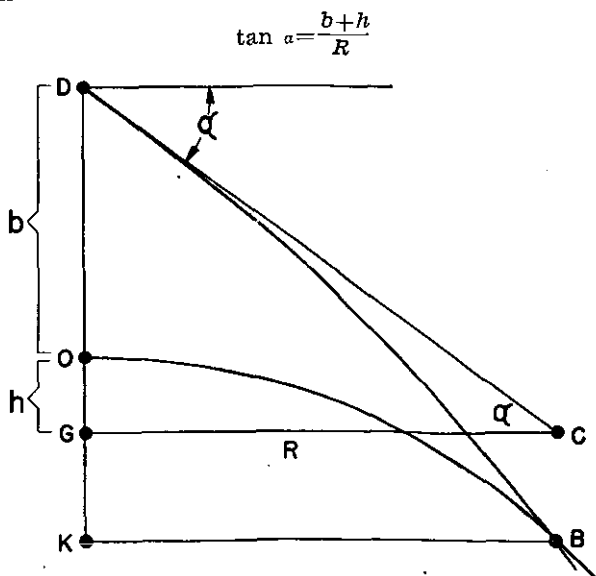

FIGURE 27.—Effect of curvature of earth and refraction.

Examine figure 28 on the depression position finder. In figure 28, r represents the horizontal distance from (5) in figure 29 to the vertical plane through the horizontal axis of the telescope. Let t be the distance from the horizontal plane through the trunnions of the telescope to the top of the

tangent screw (5) in figure 29. The acute angle formed at the trunnions is designated as:

$$\tan \alpha = \frac{t}{r}$$

$$R = \frac{b+h}{\tan \alpha}$$

$$R = \frac{(b+h)r}{t}$$

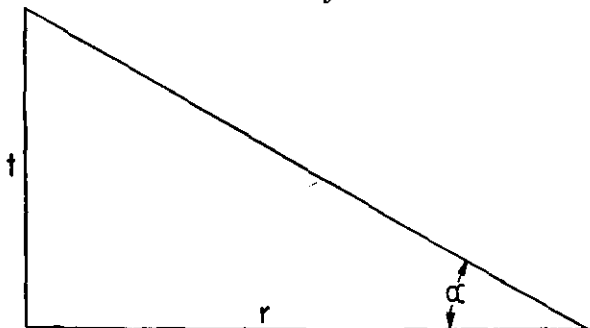
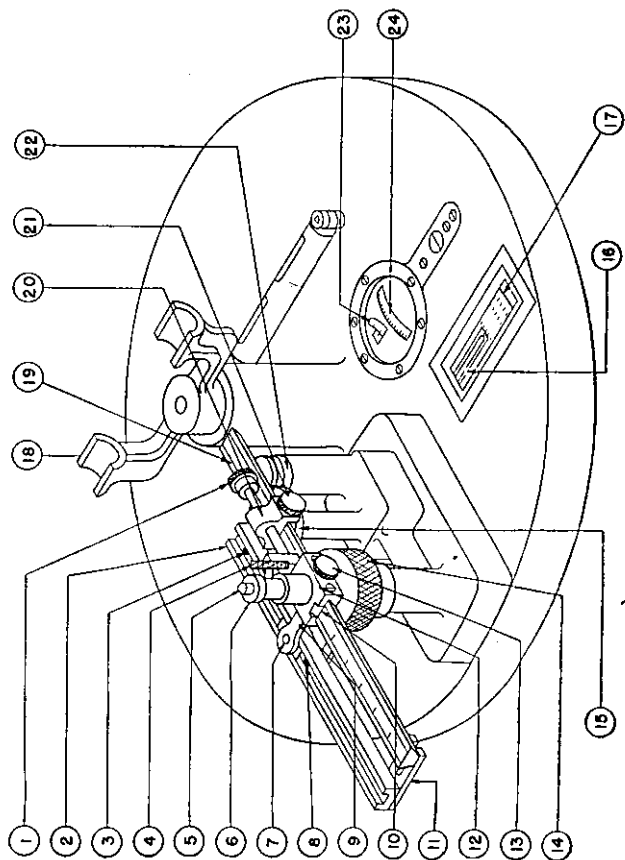

FIGURE 28.—Depression position finder triangle.

The tangent height in the compensating mechanism is called t . If the range remains constant and the height of site b is increased, the slide block is moved along the tangent screw rail toward the trunnions of the telescope, resulting in a change in the value of r corresponding to the change in the value of b . The compensating screw pin (moving with the slide block) pressing against the telescope causes the value of alpha to increase. As the slide block is moved, the compensating screw moves vertically a distance such that the lift due to the movement of the slide block, together with the vertical motion of the compensating screw, changes the angle of the telescope to position it so that the target is waterlined at the range indicated on the range dial. The above is also true when the height of site is decreased, in which case the slide block is moved away from the trunnions of the telescope instead of toward them, and the angle of depression is decreased instead of increased. It is evident, therefore, that the base length r varies for different heights of site above sea



1. Slide block adjusting screw.
2. Compensating bar.
3. Cam pin.
4. Compensating screw thumb-screw.
5. Compensating screw pin (fulcrum pin, tangent screw).
6. Compensating screw.
7. Rack pin.
8. Compensating bar pivot.
9. Rack.
10. Index of height of site.
11. Compensating bar guide.
12. Slide block.
13. Slide block thumbscrew.
14. Rear tangent screw nut.
15. Compensating cam.
16. Range pointer.
17. Range scale.
18. Telescope trunnion yoke.
19. Tangent screw rail, height scale.
20. Adjusting screw nut.
21. Adjusting screw nut thumb-screw.
22. Front tangent screw nut.
23. Azimuth scale.
24. Azimuth subscale.

FIGURE 29.—Erdman compensator, depression position finder M1907.

level. In addition, the value of r for any height of site is such that the vertical movement of the slide block and rail (resulting from turning the rear tangent screw nut) required in going from maximum to minimum range is the same for all heights of site, and the compensating mechanism introduces a correction which makes it possible to use the same range disk for different heights of site within the limits of the instrument.

■ 51. DEPRESSION POSITION FINDER M1907 (fig. 30).—*a. Description.*—The D. P. F. M1907 is a later type of instrument than the Swasey instrument. The M1907 type is issued in 15 classes, each class being specially designed for use at a different range of heights (except that classes *DM* and *DMM*

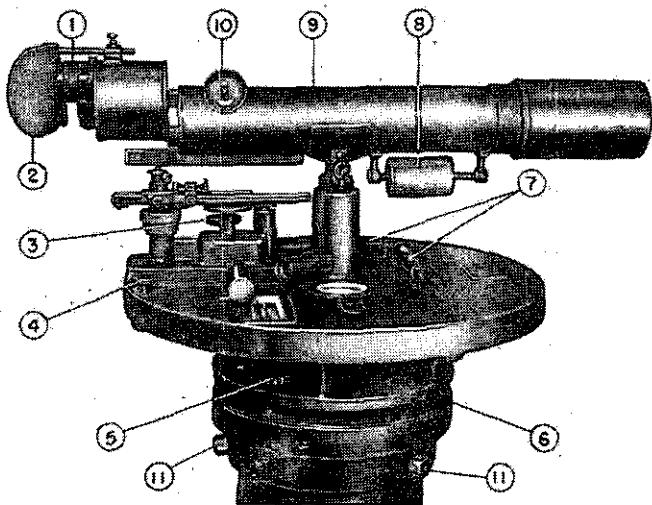

- | | |
|-------------------------|-----------------------|
| 1. Shutter sleeve. | 7. Levelling bubbles. |
| 2. Eye shade. | 8. Counterweight. |
| 3. Azimuth knob. | 9. Telescope. |
| 4. Table clamping knob. | 10. Focusing knob. |
| 5. Levelling screws. | 11. Cap Screws. |
| 6. Pedestal cap. | |

FIGURE 30.—Depression position finder M1907.

have the same range of heights; see table) with the classes overlapping so as to cover all heights from 35 to 35,000 feet. In this way, a much greater degree of flexibility of use is obtained than is possible with the older type. The instruments have interchangeable depression mechanisms, height scales, and range dials, making it possible and convenient to convert an instrument from 1 class to another.

D. P. F. M1907

Class	Heights for which designed (feet)	Limits of graduation on range scale (yards)—minimum, maximum
A.....	35-80	1,500-12,000
B.....	60-145	1,500-12,000
BM.....	60-145	1,500-15,000
C.....	125-300	1,500-12,000
CM.....	125-300	1,500-20,000
D.....	280-600	1,500-12,000
DM.....	280-800	1,500-20,000
DMM ¹	280-800	1,500-20,000
DM1.....	380-1,140	2,000-20,000
DMM1.....	380-1,025	2,000-20,000
AA.....	25-60	1,000-6,000
DD.....	160-400	1,000-6,000
EE.....	300-750	1,000-6,000
E.....	90-210	600-9,000
F.....	165-400	600-9,000
G.....	1,200-3,500	2,500-25,000
H.....	280-760	5,000-30,000
K.....	310-900	3,000-25,000

¹ Differs from DM in minor structural details.

(1) *Telescope*.—The optical system is similar to those previously described. Eyepieces are provided for 15- and 25-power magnifications. A counterweight (8) is furnished for adjusting the balance of the telescope.

(2) *Elevating mechanism*.—The elevating mechanism consists of a rear tangent screw nut and front tangent screw nut which are rotated to elevate and depress the telescope. The Erdman compensator previously described operates be-

tween these tangent screws and the telescope to introduce the compensation for heights of site other than that for which the range scale is graduated.

(3) *Table assembly.*—The table and body serve the same purpose as the cradle of the Swasey D. P. F. Their mechanical features are, however, somewhat different.

(a) The method of indicating azimuths is unique. There are three scales: the azimuth scale, concentric with the ver-

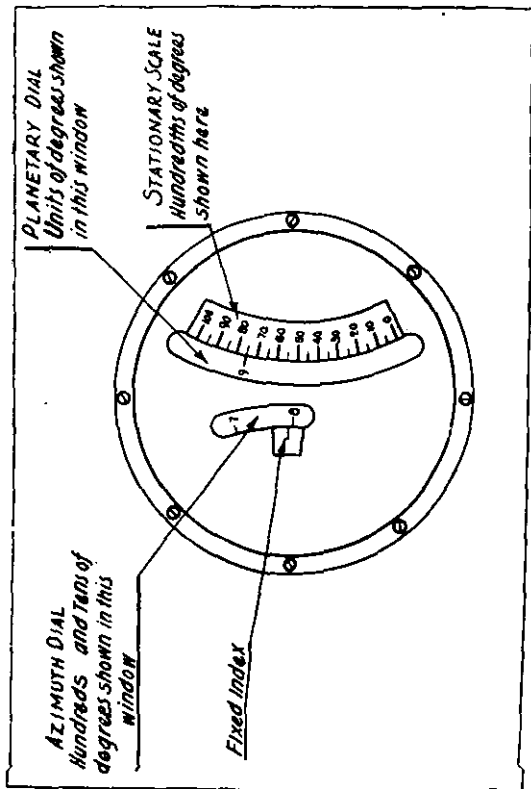

FIGURE 31.—Azimuth indication on depression position finder M1907.

tical axis of the instrument, on which are read the hundreds and tens of degrees; the azimuth subscale geared to rotate once for each 10° , on which are read the units of degrees; and the subscale vernier next to the subscale, on which are read the hundredths of a degree. The number to be read on the azimuth scale is the one in coincidence with or above the index; the number to be read on the subscale is the one that registers with some portion of the subscale vernier. The hundredths of a degree are read from the subscale vernier where the unit degree mark of the subscale registers on the vernier. The method of indicating azimuths is illustrated in figure 31.

The azimuth indicated in the figure is 79.75° .

(b) The range is indicated on a dial instead of a drum. The minimum and maximum ranges indicated depend upon the class of the instrument.

(c) The leveling mechanism has only three leveling screws, of which any two may be used together to level in one direction. The third screw should then be used with each of the others to level in the other direction, taking up one-half of the adjustment with each pair.

(4) *Base*.—The base or pedestal is similar to the one previously described for the Swasey D. P. F.

b. *Adjustment and orientation*.—(1) *General*.—The steps in adjustment and orientation of this instrument are leveling, focusing the eyepiece, focusing the objective to remove parallax, and adjusting azimuth and range. The focusing of the telescope is accomplished in a manner similar to that described for the azimuth instrument M1910A1, the objective being focused by the focusing knob.

(2) *Leveling*.—The instrument is leveled by the following procedure:

(a) Traverse the instrument until one of the bubbles is parallel to a line through two of the leveling screws. For the purpose of this discussion, call these two screws Nos. 1 and 2. The third screw is called No. 3.

(b) Center the bubble mentioned above by means of screws Nos. 1 and 2. This is done by turning the two screws simultaneously in opposite directions, both thumbs moving in or

both moving out, the bubble moving in the same direction as the left thumb.

(c) The other bubble is brought halfway to the center by using screws 1 and 3 and is brought the remaining distance by means of screws 2 and 3.

(d) Relevel the first bubble and repeat the entire procedure until both bubbles remain level.

NOTE.—If the second bubble is off level very far, it may be difficult to judge the halfway point in the adjustment. In this case bring the bubble halfway between the point where it becomes visible in the tube and the center position of the bubble.

(e) Rotate the instrument 180° and check the bubbles to see if they remain centered. If so, the bubbles are in adjustment. If either bubble moves away from the center position, that bubble is out of adjustment and should be adjusted by ordnance personnel.

(3) *Azimuth adjustment.*—Select a datum point of known azimuth. Turn the table by rotating the azimuth knob until the known azimuth is indicated on the azimuth dials, then clamp the table to the body of the instrument. Loosen the three pedestal cap screws. Insert the large adjusting pin in the hole in the side of the pedestal cap and turn the cap until the vertical cross line in the telescope coincides with the datum point. This procedure may disturb the level of the instrument. Level again and check by sighting on the datum point. Repeat until a correct setting is obtained, then tighten the three pedestal cap screws.

(4) *Range adjustment.*—(a) Having ascertained the condition of the tide at the moment, set the slide block (12) along the tangent screw rail (19) to that point on the height scale (on the tangent screw rail) which corresponds to the present height of the instrument in feet and clamp the slide block by means of the thumbscrew.

(b) Select two datum points, D_L at a range somewhat longer and D_s at a range somewhat shorter than the ranges over which it is expected to work.

(c) Point the telescope in direction at D_L and turn the rear tangent screw nut (14), which operates the depression mechanism, until the range pointer indicates the range of D_L . If the horizontal cross wire of the telescope is not on the water

line of the datum point, unclamp the compensating screw thumbscrew (4) and turn the compensating screw (6) until coincidence is established. The thumbscrew should then be tightened.

(d) Point the telescope in direction at D_s and turn the rear tangent screw nut (14) until the range pointer indicates the range of this datum point; bring the horizontal cross wire to the water line of this point by moving the slide block by means of the slide block adjusting screw (1). The adjusting screw nut (20) must be held fixed by the adjusting screw nut thumbscrew (21) while making the adjustment, and the slide block thumbscrew (13) must be loosened.

(e) Repeat these two operations until correct readings on both D_L and D_s can be obtained by operating only the azimuth hand wheel and the rear tangent screw nut. Tighten the slide block thumbscrew (13).

(f) This adjustment should be repeated at intervals, the frequency depending on the extent of the variation in tide and refraction. (See appendix III for discussion of range setting when datum point is not water lined.)

c. *Operation.*—(1) *General.*—The instrument is operated as described in paragraph 49c for the Swasey D. P. F. The target is tracked in azimuth by means of the azimuth knob (3) (see fig. 30) on the table at the left of the telescope and in range by means of the rear tangent screw nut (14) (see fig. 29).

(2) *Precautions.*—(a) The depression mechanism should not be operated until the height setting has been made.

(b) The instrument should not be forced against the stops provided for minimum and maximum depression.

(c) The eye shade (2) (fig. 30) should be kept in place at all times to preserve the proper balance of the instrument.

(d) When the 15-power eyepiece is used, the counterweight (8) (fig. 30) should be screwed all the way out; when the 25-power eyepiece is used, it should be moved in slightly.

(e) The operator, when tracking, should be careful not to disturb the balance by resting his head against the eye shade.

NOTE.—For a more complete discussion of this instrument refer to TM 9-1685.

■ 52. DEPRESSION POSITION FINDER M1 (figs. 32 and 33).—*a. Description.*—The D. P. F. M1 is the standard instrument

now issued for use with seacoast artillery. It is similar to the D. P. F. M1907. It is issued in eleven classes covering all heights of instrument from 74 to 1,395 feet and from 2,250 to 4,100 feet. The eyepiece of this instrument may be set for any desired power from 10 to 30. Amber and blue ray

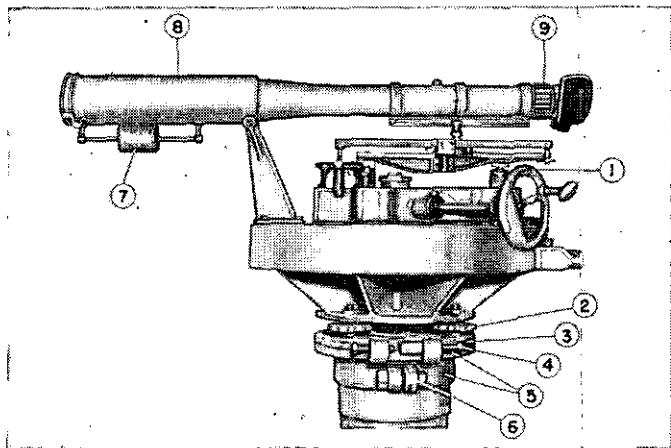

- | | |
|----------------------------|--|
| 1. Drive shaft handwheel. | 6. Leveling plate support clamping bolt. |
| 2. Leveling screws. | 7. Counterweight. |
| 3. Leveling plate. | 8. Telescope. |
| 4. Fine adjustment screw. | 9. Focusing collar. |
| 5. Leveling plate support. | |

FIGURE 32.—Depression position finder M1.

filters are provided for use when desired. The method of indicating azimuths is by an azimuth scale giving degrees and an azimuth micrometer indicating hundredths of a degree. The range is indicated by a pointer moving across a moving scale. The minimum and maximum ranges indicated depend upon the class of the instrument.

b. Orientation (azimuth).—The instrument is oriented in the following manner:

(1) Set the azimuth scale and micrometer to the azimuth of a datum point.

(2) Loosen the clamping bolt (6) of the leveling plate sup-

port (5) and rotate the plate until the telescope points approximately to the datum point.

(3) Tighten the clamping bolt of the leveling plate support and loosen the three cap screws under the lower plate and by means of the fine adjustment screws (4) (loosen one and tighten the other) make the fine adjustment to bring the

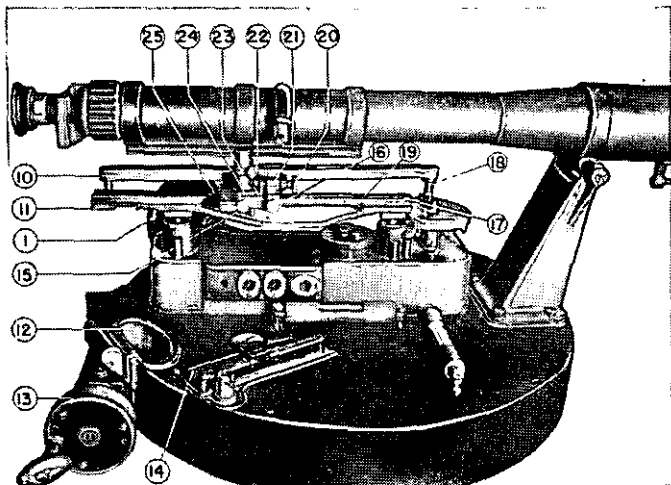

- | | |
|---|---|
| 1. Drive shaft handwheel. | 17. Tangent screw rail. |
| 10. Compensating bar. | 18. Cam pin. |
| 11. Compensating bar guide. | 19. Height scale. |
| 12. Azimuth scale. | 20. Adjusting screw. |
| 13. Azimuth micrometer. | 21. Adjusting screw nut. |
| 14. Range scale. | 22. Compensating screw thumb-screw. |
| 15. Compensating screw nut thumb-screw. | 23. Compensating screw. |
| 16. Adjusting screw nut thumb-screw. | 24. Compensating screw nut (slide block). |
| | 25. Height scale index. |

FIGURE 33.—Erdman compensator, depression position finder M1.

telescope's vertical cross wire into coincidence with the datum point. The plate should be kept leveled during these sighting adjustments.

(4) Tighten the cap screws.

D. P. F. M1

Class	Heights for which designated (feet)	Limits of graduation on range scale (yards)—minimum, maximum
1.....	74-135	1,500-20,000
2.....	100-182	2,000-24,000
3.....	150-272	2,500-30,000
4.....	260-475	2,500-38,000
5.....	350-650	2,500-45,000
6.....	450-810	5,000-50,000
7.....	575-1,045	5,000-55,000
8 ¹	750-1,395	3,000-60,000
9.....	751-1,375	5,000-60,000
10.....	625-1,160	2,500-45,000
12.....	2,250-4,100	10,000-80,000

¹ Class 8 is not fitted for use over 54,000 yards at heights below 1,000 feet and 56,000 yards at heights above 1,000 feet.

c. Adjustment for range.—(1) Before determining ranges it is essential to calibrate the instrument to secure accurate results. Three operations are necessary for complete calibration as described below. (See figs. 32 and 33.)

(a) Determine the height of tide and the corresponding height of the instrument above sea level, which height is the initial height of the instrument with the height of tide added or deducted. Slide the compensating screw nut along the tangent screw rail until the height scale index registers the height of the instrument above sea level. Clamp the compensating screw nut to the tangent screw rail at this setting. Frequent checks on tide should be made and the height corrected accordingly, as a small change in height setting will affect the range.

(b) Direct the telescope in azimuth on a datum point near the maximum working range of the instrument and rotate the drive shaft handwheel until the range of the datum point is indicated by the pointer on the range scale. If the horizontal cross wire in the telescope does not coincide with the water line of the datum point, unclamp the thumbscrew on the compensating screw and revolve the compensating screw,

raising or lowering the fulcrum pin until coincidence is obtained. The thumbscrew should then be tightened. This operation is termed "initial setting."

(c) After obtaining the initial setting of the instrument, direct the telescope in azimuth on a datum point near the minimum working range of the instrument and rotate the drive shaft handwheel until the horizontal cross wire in the telescope coincides with the water line of the datum point. If the range indicated by the pointer agrees with the range to the datum point, refraction is normal and the instrument is adjusted. If, due to abnormal refraction, the indicated range differs from the true range, the instrument is made to read the correct range by means of the drive shaft handwheel, and the compensating screw nut is moved along the height scale until the datum point is again water lined. After any movement of the compensating screw nut, the instrument is again trained on the distant datum point and adjusted by means of the compensating screw, as in the initial adjustment. The adjustments on the near and far datum points must be repeated until both indicated ranges are correct. Best results will be obtained by selecting datum points having maximum range near the maximum limits of the range scale and minimum range approximately one-third of the maximum range. This gives closer calibration for maximum ranges and therefore greater accuracy at long ranges. Minimum ranges corresponding to the minimum on the range scale should not be used unless other datum points are not available. (For orientation on datum points located on land, see appendix III.)

(2) To determine the range of a target, rotate the drive shaft handwheel until the horizontal cross wire in the telescope falls on the water line of the target. The range is then indicated on the range scale opposite the pointer.

d. Operation.—The instrument is operated as described in paragraph 49c for the Swasey D. P. F. The target is tracked in azimuth by means of the handwheel on the azimuth micrometer (13) and in range by means of the handwheel (1) (figs. 32 and 33). The same precautions apply to this instrument as to the M1907 D. P. F. (par. 51c).

NOTE.—For a more complete discussion of this instrument, refer to TM 9-1695.

SECTION IV

SELF-CONTAINED RANGE FINDERS

■ 53. GENERAL.—*a.* The self-contained base system utilizes range finders having the base line within the instrument itself. It may be used for determining range in rapid fire batteries or as an alternate method for other batteries at ranges within its capabilities. (See FM 4-10.) The self-contained range finders used in seacoast artillery are of either the coincidence type or the stereoscopic type. The coincidence types are limited standard and will be used as long as the present supply lasts but no new ones are being built. The stereoscopic type is substitute standard and will be issued when current supplies of coincidence range finders are exhausted. Both instruments solve a right triangle, one leg of which is a self-contained base line which is compared to the range to be determined; therefore, the angles to be measured are extremely small.

b. The triangle to be solved by a coincidence range finder is as shown in figure 34. AB is the base line, C is the target,

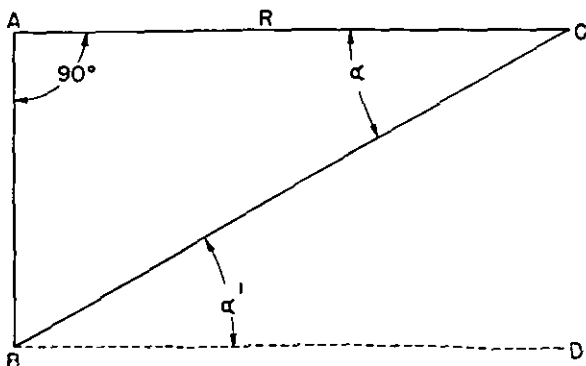

FIGURE 34.—Coincidence range finder triangle.

and AC is the range R . The length of the base line AB and the angle BAC (90°) are maintained constant by the construction of the instrument. By examining the figure it can be seen that α is equal to α' when

BD is parallel to AC and in the same plane as AC . The instrument, in effect, measures the angle alpha. Since in this right triangle, if the angle alpha and the base line AB are known, the range R can be determined by the tangent function of alpha.

$$\tan \alpha = \frac{AB}{R}$$

$$R = \frac{AB}{\tan \alpha}$$

Consequently, the apparatus which measures the angle alpha may be graduated in terms of range. As the value of alpha increases, the range decreases, and when the value of alpha decreases, the range increases. The change in alpha therefore registers a change in the range.

■ 54. PRINCIPLES OF COINCIDENCE RANGE FINDERS.—For measuring range by the coincidence method, there are two standard instruments: the 9-foot instrument and the 15-foot instrument. Each of these coincidence range finders is named for the length of its base line. Because of its longer base line, the 15-foot instrument is more accurate than the 9-foot instrument. The principles of the 9-foot and the 15-foot instruments are practically the same. In general, the construction of these two range finders is also similar in that each consists of a long tube having a window at each end behind which are mounted penta prisms. These prisms reflect the light from the target or object viewed through the optical systems into the eyepiece at the middle of the tube. The field of view is divided horizontally into two halves, one of which comes through the left penta prism and one through the right. The small angle α in figure 34 is determined by a measuring wedge which is used to bring the two partial images into coincidence. The method of doing this is slightly different for the two instruments and will now be explained in detail.

■ 55. 15-FOOT COINCIDENCE RANGE FINDER.—*a. Theory of 15-foot instrument.*—In the 15-foot instrument, the base of the triangle is the distance between the centers of the penta objective prisms at each end of the telescope body. The angle between the base line and the line to the target from the left-hand end of the range finder is constant and is a

right angle, and the angle between the base line and the line to the target from the right-hand end of the range finder is the variable angle. When coincidence is obtained the range in yards may be read directly on the scale or range indicator. When the upper and lower halves of the image are coincident, and when the instrument is in proper adjustment, the two lines of sight from the ends of the base of the range finder will meet at a point situated at the range indicated on the range scale. The telescope body contains separate optical systems in each half which transmit light to a common field eyepiece so that the partial images of the target may be seen simultaneously. The telescope system in the right half forms an erect partial image in the lower half of the field, while the system in the left forms an erect partial image in the upper half of the field.

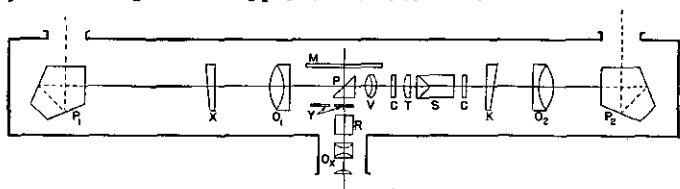

FIGURE 35.—Optical system of 15-foot coincidence range finder.

The contents of each system are outlined as follows:

Left telescope system

Left penta objective prism

(P_1)

Correction wedge (X)

Left objective lens (O_1)

Right telescope system

Right penta objective prism

(P_2)

Right objective lens (O_2)

The measuring wedge (K)

Parts contained in both systems

Coincidence prism (S)

Collective lens (T)

Magnification lens (V)

Erecting prism (P)

Ray filter lenses (Y)

Ocular prisms (R)

Eyepiece lenses (O_x)

Range scale (M)

Astigmatizer lenses (C)

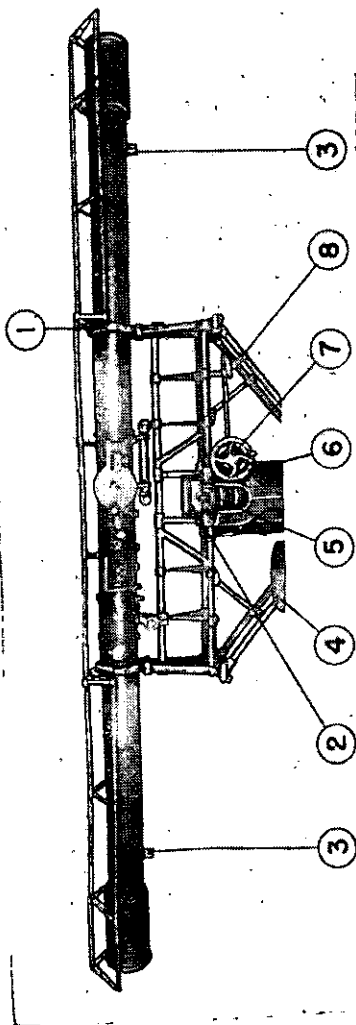

1. Bearing rings.
2. Adjustable rheostat.
3. Calcium chloride cells.
4. Observer's seat.
5. Azimuth circle.
6. Azimuth handwheel.
7. Micrometer drum.
8. Throw-out crank handle.

FIGURE 36.—15-foot coincidence range finder.

The optical system of this C. R. F. is composed of lenses and prisms. P_1 and P_2 are penta objective prisms; O_1 and O_2 are objective lenses used for focusing; M is a range scale. The correction wedge X appears on the left-hand side. The measuring wedge K appears on the right-hand side of the instrument and its position when coincidence is established measures the size of the variable angle. The lenses marked C are the astigmatizer lenses. S is the coincidence prism and T is the collective lens. V is the magnification lens. P is the erecting prism, R is an ocular prism, and O_x are the eyepiece lenses. The ray filter lenses are lettered Y . The penta prisms P_1 and P_2 turn the rays of light through an angle of 90° . The light rays entering on the right-hand side are reflected through the telescope to coincidence prism (S) reflecting the lower half of the image, while the light rays entering on the left-hand side are reflected through the telescope to the coincidence prism (S) reflecting the upper half. When coincidence is obtained, the image is magnified by V and the composite image is erected by P through to the ocular prism R , where it is turned through an angle of 90° to the eyepiece lenses.

b. Description.—The instrument is 17 feet long. It is composed of the pedestal mount and telescope body. The pedestal mount is the stationary stand about which the telescope body rotates. It serves as a support for the telescope body. Attached to the telescope body are the bearing rings, eyepiece, mechanical range indicator, periscopic finder, and knobs necessary for operating the instrument. Windows of optical glass are provided at each end of the instrument to admit light rays to the penta prisms. These windows are wedges of small angle and each is secured to the telescope body by screws. Each window is provided with a hinged metal protective cap. The instrument is equipped with six 6-volt lamps controlled by a three-way snap switch and an adjustable rheostat. They are arranged to throw light on the internal adjuster collimator cross wires, the interior range scale, the mechanical range indicator, the azimuth circle, and the micrometer drum. Intensity of the lights may be varied by the rheostat. Calcium chloride cells are located on the under side at either end of the telescope body. They ab-

sorb any moisture which may gather in the interior of the instrument. The eyepiece may be moved vertically by means of a screw, restoring realignment between the optical tube and the eyepiece. The rubber facepiece moves horizontally on a bar, permitting the operator to observe with either eye. Two powers are provided, giving magnifications of 15 and 28 diameters. Magnification may be changed by turning the CHANGE OF MAGNIFICATION knob, which is on top of the tube. For the higher magnification, turn clockwise; for the lower magnification, turn counterclockwise. The range indicator is designed to measure the displacement of the meas-

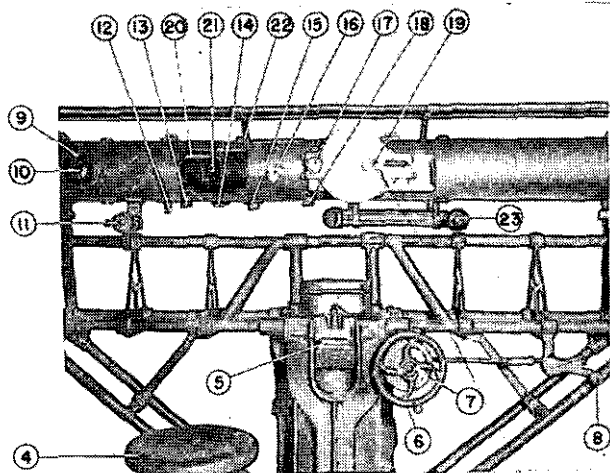

- | | |
|-----------------------------|-----------------------------------|
| 4. Observer's seat. | 15. Prism turning knob. |
| 5. Azimuth circle. | 16. Astigmatizer knob. |
| 6. Azimuth handwheel. | 17. Measuring knob. |
| 7. Micrometer drum. | 18. Wire relief knob. |
| 8. Throw-out crank handle. | 19. Mechanical range indicator. |
| 9. Correction wedge knob. | 20. Rubber face piece. |
| 10. Correction wedge dial. | 21. Eyepiece. |
| 11. Elevating knob. | 22. Change of magnification knob. |
| 12. Halving adjusting knob. | 23. Periscopic finder. |
| 13. Ray filter knob. | |
| 14. Adjusting knob. | |

FIGURE 37.—15-foot coincidence range finder—operating mechanisms.

uring wedge and is graduated in yards. The movement of the measuring wedge is approximately proportional to the square root of the range. The periscopic finder is a low-power, wide-field telescope provided for promptly finding the target. It is secured to the underside of the telescope body and to the right of the eyepiece. It is provided with a focusing head. The periscopic finder's optical system is equipped with cross wires permitting the trainer to obtain an accurate setting on the target. The objective end of the finder is in the center of rotation of the mount.

c. Adjustment.—(1) *Azimuth adjustment.*—Although the azimuth scale on the instrument is graduated to the nearest $.01^\circ$, the instrument is not accurate for azimuth measurement. It is useful, however, for roughly locating a target in azimuth. Approximate orientation is originally accomplished by placing the pedestal in the proper position. Exact orientation is accomplished by sighting the instrument on a datum point, loosening the azimuth scale cap retaining screws and the azimuth scale screws, and slipping the azimuth scale until the azimuth of the datum point is opposite the index. The micrometer drum is similarly adjusted by loosening the micrometer screw and slipping the micrometer scale. All screws are tightened after completing the adjustments.

(2) *Focusing adjustment.*—(a) Focusing is the first adjustment which must be made on the telescope body. In focusing, proceed as follows:

1. Screw the eyepiece all the way out.
2. Select a target having a background of good contrast.
3. Then gradually screw the eyepiece in until the halving line is sharply defined.

(b) Proper focusing is only attained by screwing the eyepiece inward. If the proper focusing position is passed, the process must be repeated as in (a) above.

(3) *Halving adjustment.*—The eyepiece must be focused before attempting the halving adjustment. A displacement of the inner tube in a vertical plane or a displacement of the penta objective prism will cause a shifting of the partial images in opposite vertical directions. If halving is cor-

rect, the top of the object will appear above the dividing line at the instant it disappears from the lower field when the instrument is elevated by turning the elevating knob located at the left of the eyepiece. If the partial image appears in the upper half too soon, there is an error of duplica-

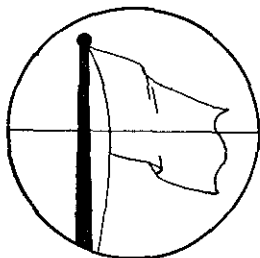

PROPER HALVING

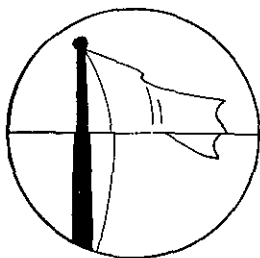

DEFICIENCY

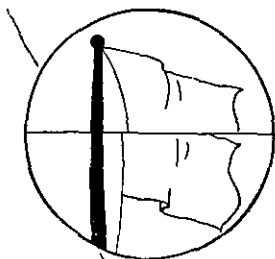

DUPLICATION

FIGURE 38.—Halving adjustment.

tion; if too late, an error of deficiency. To correct the error, the halving adjusting knob on the underside of the telescope body to the right of the elevating knob, which affects only the upper image, is rotated counterclockwise to correct deficiency. It is turned clockwise to correct duplication. The adjustment should be made before each use of the instrument. If it is in sustained use, the adjustment should be made once each $\frac{1}{2}$ hour or when a new operator

comes on duty. There are two methods of making the halving adjustment. For each method, remove the halving adjusting cap. By the first and more accurate method, the dividing line is set on a horizontal line of the object by rotating the elevating knob. The halving adjusting knob is turned until the image appears in the lower field exactly when it disappears from the upper field. To test this halving, elevate and depress the instrument by the elevating knob, observing whether the horizontal line disappears from the lower field at the same time it begins to appear in the upper field and vice versa. If not, further adjust the halving. Alternatively, the dividing line may be set on an object which preferably has a triangular outline. The object in the field eyepiece may appear partly duplicated or it may appear deficient; that is, a portion of the object may be missing. The halving adjusting knob is then rotated to correct the error.

(4) *Adjustment for range.*—There are three general methods of adjusting the instrument for range: the datum point method, the internal adjuster method, and the infinity adjustment method. In any of these cases, the wire relief knob is rotated to **RELIEVED** position and the eyepiece is focused.

(a) *Datum point method.*—Select a datum point. Set the range scale to the known range of the datum point by means of the measuring knob. If the partial images do not coincide, remove the correction wedge knob cap, look through the eyepiece, adjust the correction wedge knob until the proper coincidence of the partial images is obtained. Observe the reading on the correction wedge dial. Ten correction wedge dial readings are taken. Average them and set the dial to this average. After having completed this adjustment, replace the cap over the knurled correction wedge knob.

(b) *Internal adjuster method.*—Set the internal range scale at the infinity position by turning the measuring knob counterclockwise. Then turn the adjusting knob about one turn against a stop. The adjusting knob brings the two penta adjusting prisms in position to receive the light from one collimator and reflect it through the range finder. Upon

looking into the eyepiece, the two half images of the collimator line will appear displaced. To bring them into coincidence, unscrew the correction wedge knob cap and turn the correction wedge knob until a perfect coincidence of the two lines is made. Coincidence is obtained four more times. Observe and note each reading on the correction wedge dial, and then turn the prism turning knob marked *A-B* clockwise against its stop. This rotates the two penta adjusting prisms 90° and the rhomboid prism 180° . This brings the other collimator into use. Again obtain coincidence five times as above, noting the reading each time. The average of all ten readings is now set on the correction wedge dial which is graduated from 0 to 100. After having completed this adjustment, replace the cap over the knurled correction wedge knob, turn the adjusting knob to a stop, and the range finder will be ready for use.

(c) *Infinity adjustment method.*—When there are no objects at known range from the instrument or when the adjustment must be made at night, the moon, a bright star, or the sun may be used. The astigmatizer is employed in making this adjustment, causing the star or moon to appear as a streak of light. Turn the astigmatizer knob counter-clockwise against its stop. By means of the measuring knob, set the internal range scale* to infinity and then rotate the correction wedge knob until the lower and upper halves of the streak of light are in coincidence. At least ten readings should be taken and averaged. Set the correction wedge dial to the average of these readings. The instrument is now in adjustment for range.

(d) *Ray filter.*—The ray filter consists of a smoked lens and an amber lens and is operated by the ray filter knob located on the underside of the telescope body directly beneath the eyepiece. The smoked lens is used for observing rays of bright light, such as the sun or a searchlight. The amber lens is used to moderate exceptionally bright days.

*The internal scale is a glass strip with its divisions and figures engraved in black. The measuring wedge moves along the inside scale and indicates range. In order to adjust for coincidence, provision is made for moving the scale independent of the measuring wedge. On it is registered infinity range for adjusting the range finder at night.

d. Operation.—(1) *Tracking.*—The instrument is operated by three men: an observer, a trainer, and a reader. The observer's seat is on the left; the trainer's on the right. The reader stands behind the instrument where he can see the range scale. If a plotting board or a time-range chart is used, the reader may have a telephone connected with personnel on those instruments. The observer receives the command assigning the target and tracks the target in range. Before commencing operation, all adjustments, such as halving and coincidence, should be checked carefully. To identify a target indicated by azimuth and description, the trainer releases the clutch (if not already released), traverses the instrument to the azimuth indicated, and by sighting

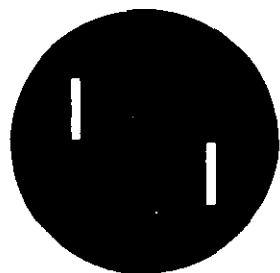

LACK OF COINCIDENCE

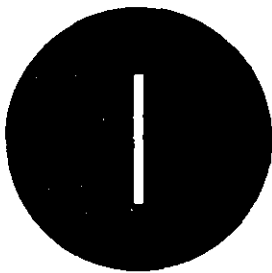

COINCIDENCE

FIGURE 39.—Astigmatizer effect on a point of light.

over the eyepiece verifies the approximate direction of the target. Releasing the clutch permits the instrument to be traversed rapidly without using the handwheel. The trainer identifies it by using the finder, bringing the intersection of the finder cross wires on the portion of the target most suitable for observation. He should select some part of the target which will allow coincidence to be made on a well-defined line perpendicular to the halving line. When on the target, the trainer engages the clutch and starts tracking. By sighting through the eyepiece, the observer brings the two partial images of the target into alinement. When coincidence is exact, he may read the range from the inside range scale, but preferably the reader reads the range from the external range scale.

(2) *Methods of reading range.*—There are two general methods of taking ranges, the first method discontinuous and the second continuous. In the discontinuous method, the operator puts the instrument out of coincidence as soon as a reading is taken. In the continuous method, the operator endeavors to maintain coincidence at all times. With well trained observers the continuous method will usually be found the more suitable at short and medium ranges with good visibility. However, at the longer ranges or with poor visibility, the discontinuous method will ordinarily be preferable. In training, the discontinuous method is taught before the continuous method is attempted, and it is well to maintain drill in the discontinuous method in order that the observer will have a critical attitude toward the coincidence he is making. During tracking with the continuous method, if the observer has any reason to doubt the correctness of his coincidence by reason of increased range or decreased visibility, he should immediately shift to the discontinuous method. In this way the discontinuous method serves as a check upon the natural tendency to stretch coincidence by maintaining the established rate of change. The observer indicates any change in system to the reader. For example, when changing from the continuous system to the discontinuous, the observer would announce, "Discontinuous," and when changing from the discontinuous to the continuous announces, "Continuous." When using the discontinuous method the observer indicates coincidence by calling, "Read."

(3) *Special precautions to insure accuracy.*—(a) To insure the greatest accuracy, the alinement of the partial images should be made on a clearly defined portion of the target. Engagement of the clutch with the worm gear permits the trainer to traverse the range finder slowly in azimuth. When the clutch is disengaged, the observer and trainer can turn themselves and the instrument rapidly and freely in azimuth. Either method of turning may be used in following a target, but it will be found convenient to release the clutch only when changing targets or when following a fast-moving target. If the clutch remains disengaged while tracking, the tracking will be jerky.

(b) The observer operates the elevating knob with his left

hand from time to time to keep the halving line on the most favorable part of the target.

(c) In using the astigmatizer for night observations, tracking should be on small rather than large luminous objects.

(d) Fifteen minutes should be the maximum duration of any one observing period. The reader, however, can read over long periods of time. Since direction as well as range of the target is required, some means must be provided for furnishing target azimuths. The range finder is not accurate enough as an azimuth-measuring instrument. Consequently, azimuths must be read from a separate azimuth instrument set up near the range finder.

■ 56. NINE-FOOT COINCIDENCE RANGE FINDER.—*a. Theory of 9-foot instrument.*—The 9-foot instrument is based on the same principles as the 15-foot instrument. However, in the 9-foot instrument the variable angle is on the left-hand side while the 90° angle is on the right-hand side. There are two dependent telescopic systems: the group in the right-hand part forms an erect partial image in the upper field, and the group in the left-hand part forms an erect partial image in the lower field. The right optical system consists of a penta objective prism (A_2) (fig. 40), an objective lens (B_2), an equal magnification lens (D), a halving glass (G), an astigmatizer lens (H_2), and the eyepiece prisms (E). The right-hand objective is of longer focal length than the left-hand, and an equal magnification lens corrects for the difference. The halving glass is rotatable about a horizontal axis. Rotation of the glass produces a vertical displacement of the pencil of rays. The astigmatizer lens, having a different curvature in its vertical and horizontal planes, produces vertical distortion of the image. The eyepiece prisms are three in number and are so arranged as to erect the image and to reflect the light up to the separating prism at such angles as to allow only those rays from the right objective to be refracted in the upper field, and only those rays from the left objective to be refracted in the lower field. The left telescopic system consists of a penta objective prism (A_1), an objective lens (B_1), a deflecting prism (K_1), and also the eyepiece prisms (E). The deflecting prism is built of two prisms

to correct for the dispersion of light. When sighting an object at distant range, the prism is in the position *K*. When sighting on an object at near range, the prism is in the *J* position.

b. Description.—(1) The instrument consists of a built-up telescope body about 9 feet long supported on a pedestal mount. Windows of optical glass are provided at each end of the instrument. These windows are ground optically flat and parallel. A penta objective prism carrier fits into the end castings and has a carefully designed framework for housing the penta objective prism. Attached to the telescope body are the bearing rings, eyepieces, working-head cover ring, inner tube, and end reflectors. The working-head cover ring includes the deflecting head coincidence adjusting slider, halving adjusting head, and the astigmatizer slider.

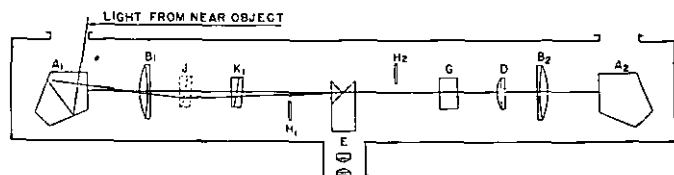
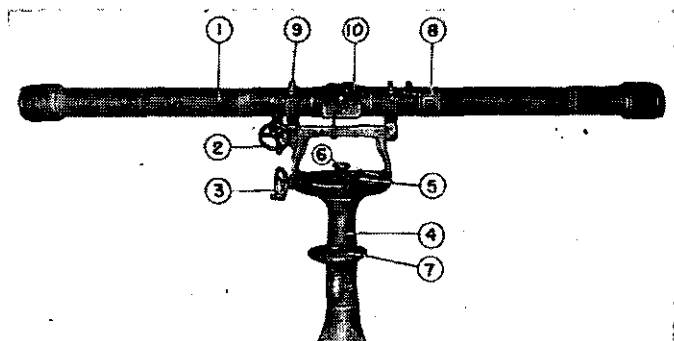

FIGURE 40.—Optical system of 9-foot coincidence range finder.

(2) There are three eyepieces. The field eyepiece is on the right and the scale eyepiece on the left. Just below the field eyepiece is situated the finder eyepiece, provided with a focusing head. The finder eyepiece pertains to an optical system independent of the optical system of the range finder. The parts of this telescopic system consist of an objective lens below the scale-illuminating window; a double-reflecting finder penta prism, which reflects the light through an angle of 90° ; and the finder prisms, which erect the image and deflect the pencil of light up into the eyepiece. At the top of the middle of the telescope body a lamp bracket is attached. Inside the bracket is mounted an ebonite holder, which carries a $4\frac{1}{2}$ -volt lamp. This lamp serves to illuminate the scale for night use. The working-head cover ring is located within reach of the observer's right hand. Its movement is limited by a stop screw, which serves also for locking the ring in the

operating or halving position. When in operation, the working-head cover ring can be positioned in two ways: all heads and sliders may be exposed, or the halving adjusting head and coincidence adjusting slider may be covered, leaving the deflecting head and the astigmatizer slider exposed. For adjusting, the working-head cover ring is positioned so that all heads are exposed.

(3) The deflecting head (roller) is mounted on the top of the telescope body at the right-hand side within convenient reach of the right hand, the thumb being left free for working the light switch (to control light illuminating range scale). The deflecting head operates the scale drum and



- | | |
|------------------------------------|-----------------------------|
| 1. Telescope body. | 6. Friction clutch. |
| 2. Elevating handwheel. | 7. Observer's seat. |
| 3. Traversing handwheel (azimuth). | 8. Working-head cover ring. |
| 4. Pedestal mount. | 9. Bearing rings. |
| 5. Azimuth disk. | 10. Eyepieces. |

FIGURE 41.—Nine-foot coincidence range finder.

deflecting prisms simultaneously by means of flexible couplings, a deflecting rod, and gear shaft. When the head is rotated, the spiral range scale is revolved past the scale index seen through the scale eyepiece (left eyepiece), the deflecting prism screw is operated simultaneously, and the deflecting prism is translated along the path of the beam of light, which enters the left end of the range finder.

(4) The coincidence adjusting slider enables the range

scale to be moved independently of the deflecting prism. When the slider is moved to the left, the coincidence gear shaft is slipped endwise so as to disengage the wheel which drives the deflecting prism screw. The driving pinion of the spiral range drum is of sufficient length to remain always in mesh with the teeth of the drum; and thus, when the slider is moved endwise, the deflecting head drives the scale drum only and not the deflecting prism screw. This enables the scale to be set at the known range after the images of the object in the field of view have been brought into exact coincidence. After the scale has been set to read the correct range, the slider is again returned to the right.

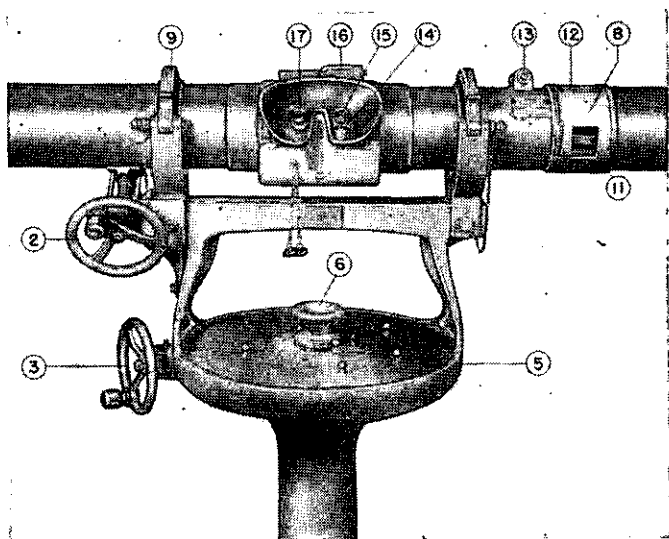

- | | |
|------------------------------------|-----------------------------------|
| 2. Elevating handwheel. | 11. Halving adjusting head. |
| 3. Traversing handwheel (azimuth). | 12. Coincidence adjusting slider. |
| 5. Azimuth disk. | 13. Light switch (lamp push). |
| 6. Friction clutch. | 14. Finder eye-piece. |
| 8. Working-head cover ring. | 15. Field eye-piece. |
| 9. Bearing rings. | 16. Lamp bracket. |
| | 17. Scale eye-piece. |

FIGURE 42.—Nine-foot coincidence range finder—operating mechanisms.

(5) The halving adjusting head (roller) is situated below the coincidence slider and operates the pivoted halving glass housing. Thus the halving glass is tilted, and the image in the upper field of the eyepiece is raised or lowered.

(6) The astigmatizer slider, by means of which the astigmatizer can be placed in the optical system to draw points of light into streaks suitable for coincidence work, is located under the working-head cover ring on the under side of the tube. To astigmatize the object in the field of view, the slider should be moved toward the middle of the instrument. The optical system of the 9-foot instrument is similar to that of the 15-foot instrument.

(7) The traversing mechanism is housed within the disk protector. Slow motion in azimuth is obtained by means of a traversing handwheel keyed to a worm shaft which is held in contact with the traversing worm wheel by an adjustable bearing. The worm wheel fits on the spindle and may be prevented from turning on the spindle by tightening the friction clutch in the center of the azimuth disk, which forces the friction cone down against the conical seat on the upper inner surface of the worm wheel. When the friction clutch is released, the instrument may be traversed freely without operation of the traversing handwheel. The azimuth disk is an adjustable disk mounted on the disk protector, and carries at its outer edge an azimuth scale.

(8) The elevating gearing consists of a rack screwed to the case of the range finder, an elevating handwheel, and an elevating worm shaft mounted on the elevating bracket bolted to the left arm of the mount.

c. Adjustment.—(1) *Azimuth adjustment.*—The 9-foot instrument, as well as the 15-foot instrument is not sufficiently accurate for azimuth determination but can be oriented for the purpose of identification of targets. Orientation may be accomplished by unscrewing the friction clutch, turning the azimuth disk to its proper setting, and screwing down the friction clutch.

(2) *Focusing adjustment.*—(a) Focusing is the first adjustment which must be made on the telescope body. In focusing, proceed as follows:

1. Screw the eyepiece all the way out.
2. Select a target having a background of good contrast.
3. Then gradually screw the eyepiece in until the halving line is sharply defined.

(b) Proper focusing is obtainable only by screwing the eyepiece inward. If the proper focusing position is passed, the process must be repeated as in (a) above.

(3) *Halving adjustment.*—An object viewed in the field eyepiece may appear partly duplicated or it may appear deficient. The same procedure is followed here for proper halving adjustment as was followed for the 15-foot instrument. The halving adjusting head is rotated down to correct deficiency and up to correct duplication.

(4) *Adjustment for range.*—Bring the image of an object at known range into accurate alinement by means of the deflecting head. If the scale does not indicate the true range of the object, move the coincidence adjustment slider to the left to disengage the deflecting prism gear. Next, set the scale to indicate the correct range by means of the deflecting head. Now push the coincidence adjustment slider to the right, reengaging the deflecting gear, and at the same time, move the deflecting head slightly to insure that the teeth of the spur wheel are engaged fully. Now, by means of the deflecting head, coincidence is obtained 10 times and the 10 readings are averaged. The scale is now set to this average, causing a corresponding movement of coincidence. Push the coincidence adjustment slider to the left and set the scale at the known range to the datum point. The scale reads the true range when the instrument is in coincidence. Return the coincidence adjustment slider to the right. On both instruments coincidence adjustment should be checked at two or more known ranges, one of which should be at as long a range as permits good definition. The errors due to faulty coincidence adjustment vary approximately as the square of the range. This adjustment should be made with great care and, when possible, under favorable weather conditions. For making observations at night when there are no objects at known range, the same procedure is followed as in the 15-foot instrument, using the astigmatizer.

d. Operation.—(1) The instrument is operated normally by one man, an observer. The adjustments are the same as explained before. To identify a target assigned to him by azimuth and description, the observer rotates the instrument slowly by turning the traversing handwheel, or for large changes in azimuth, by releasing the friction clutch and turning the instrument with his feet. After the instrument is directed to indicate the azimuth, the observer sights over the eyepiece and verifies the approximate direction of the target. He identifies it by use of the finder, bringing the intersection of the finder cross wires on the portion of the target most suitable for observation. Then, by sighting through the right (field) eyepiece and working the deflecting head, he brings the two partial images of the target into alinement. When coincidence is exact, he raises his fingers from the deflecting head and reads the range in the scale eyepiece (left), using his thumb to operate the light switch for illuminating the scale when making observations at night. To insure the greatest accuracy, the alinement of the partial images should be made on a clearly defined portion of the target. The friction clutch and the worm gear operated by the traversing handwheel permit the observer to turn the range finder slowly in azimuth. When the friction clutch is loose, the observer can turn himself and the instrument freely in azimuth. The left hand is needed both to traverse and elevate the instrument. (See also par. 55*d*.)

(2) In using the astigmatizer at night, tracking should be on small rather than large luminous objects. Proper precaution should always be taken to be sure that the partial images of the same light are made to coincide. This identification can be made by removing the astigmatizer for a moment and then placing it in the field, or by moving the astigmatizer halfway into the field, leaving the left half clear; then, by a slight motion in elevation, the object can be astigmatized if desired.

■ 57. STEREOSCOPIC RANGE FINDER.—*a.* The stereoscopic type of range finder in appearance and construction is similar to the coincidence type previously described except for the fact that both eyes are used to view the image. There are

two separate optical systems. Each eye receives an image of the target from its own optical system. The two images are fused so that the observer obtains the perception of depth. A system of measuring wedges is inserted in one optical system permitting the line of sight to be deflected to any desired position. The angle through which the line of sight is deflected will determine the distance at which the fused image appears from the observer. Each eyepiece is provided with a reticle containing a mark. When these marks are viewed with both eyes, they appear to fuse into one mark located at a fixed distance from the observer providing a reference point for the instrument. By means of the measuring wedges, the position of the target in depth is varied until the target appears at the same distance as the reference mark. The mechanism by which the measuring wedges are controlled operates an indicator which shows the range to the target when stereoscopic contact is made between the target and the reference mark. For further information on the construction, adjustment, and operation of the stereoscopic range finder, see TM 4-250.

b. The stereoscopic observer must have a high degree of depth perception in order that ranges may be read with the desired precision. Ordinarily, it can be expected that a very few men in each battery will have the necessary ability and these can be found only by testing the entire battery for depth perception. When competent men have been discovered, they must be trained thoroughly and must drill frequently to retain their skill in observing.

CHAPTER 8

REFERENCE NUMBERS

■ 58. GENERAL.—In the process of determining firing data it is necessary to apply corrections to the map range and azimuth of the target. These corrections may be either plus or minus. Experience has proved that mistakes are frequently made by erroneously applying the corrections and adjustments; that is, up instead of down, or right instead of left. To reduce the possibility of mistakes, reference number systems have been adopted. Reference number systems are groups of arbitrary numbers employed to represent actual values of units of measure used in seacoast artillery firing. In addition to reducing the possibility of mistakes, they are used to expedite the transmission of data. These reference number systems are so chosen that plus or minus or right or left designations are not necessary. A particular number is selected to represent normal or no correction, and any deviation from this number either up or down or right or left, represents the amount and direction of the actual correction to be applied. There are different systems in use for range and azimuth. For range corrections a reference number greater than normal indicates an up correction and conversely a number less than normal indicates a down correction. For azimuth and deflection corrections, reference numbers above normal indicate right corrections, numbers less than normal indicate left corrections. When applied to azimuths or deflections this rule may be followed, "Right, raise—left, lower," which means if we wish to move or correct the line of fire to the right we raise or increase the deflection or azimuth. If we wish to move or correct the line of fire to the left, we lower or decrease the value of azimuth or deflection. (For further discussion see par. 106.) Following are some examples of reference number systems used by seacoast artillery.

■ 59. DEFLECTION.—Deflection for seacoast artillery is measured in degrees and hundredths of a degree. (See note,

par. 12.) The original deflection reference number system employed numbers from 1.00 to 5.00 with 3.00 as normal. In this system a deflection of left 1.20° was represented by a reference number of 1.80 ($3.00 - 1.20$). A deflection of right 1.20° was represented by a reference number of 4.20 ($3.00 + 1.20$). Note application of the rule of "Right, raise—left, lower." (See fig. 43.) Due to the increased range of modern guns and to the higher speeds of targets, with the consequent possibility of larger deflections, this system was found to be inadequate and two new systems were introduced, one with a normal of 6.00, the other with a normal of 10.00. The principle of each is the same as shown in figure 43 for the normal of 3.00. With a normal of 10.00 a deflection of left 1.20° is represented by a reference number of 8.80 ($10.00 - 1.20$). A

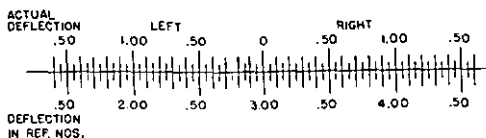

FIGURE 43.—Example of a reference number scale for deflections.

reference number system with 200 as normal is usually used to represent deflections for 155-mm guns equipped with sights graduated in mils. In any case the reference number system used on the apparatus computing the deflection must conform to the system used on the gun sight scale. For example, the sight of a certain gun has a normal of 10.00 on the deflection scale. The deflection board on which firing data are computed must also use a deflection scale having a normal of 10.00. All instruments on which deflections are set are provided with a scale of reference numbers. The interior scales of azimuth instruments (par. 46) are graduated in reference numbers for deflection but with the scale reversed so that left deviations are read greater than normal. With this arrangement the reference number of the deviation is the same as that of the deflection to be set on the gun sight in order to correct for that deviation. In all the above systems of reference numbers, an increase in deflection will cause the gun to shoot to the right and a decrease will cause

it to shoot to the left. The easy rule for remembering this, as mentioned before, is: "Right, raise—left, lower."

■ 60. ANGULAR TRAVEL.—On the plotting board M1904 angular travel is measured in degrees and hundredths of a degree. The reference numbers have a normal of 15.00. In this system an angular travel of left 1.35° is represented by a reference number of 13.65, and an angular travel of right 1.35° by a reference number of 16.35. The reference numbers on the travel computing mechanisms of the deflection board M1 are in degrees with a normal of 6.00. A reference number greater than 6.00 indicates angular travel to the right. Angular travel, as measured by the angular travel computer (par. 104), is determined in reference numbers. The system used must conform with that used on the accompanying deflection board. The rule, "Right, raise—left, lower," is still applicable. If the target is traveling left to right, the reference number indicating the angular travel of the target will be greater than normal; and conversely, if the target is traveling right to left, the reference number will be less than normal.

■ 61. WIND.—On the wind component indicator (or wind-resolving mechanism on the deflection board M1), a reference number system using 50 as normal has been adopted. The system extends from 0 through 50 to 100. For range components, a reference number of 50 indicates a range component wind of 0 miles per hour. A reference number greater than 50 indicates a range component tending to assist the projectile in flight and increase the range (tail wind). A reference number less than 50 indicates a range wind component tending to retard the flight of the projectile and decrease the range (head wind). For direction components, a reference number of 50 indicates no cross wind component. A number greater than 50 indicates a cross wind component blowing the projectile to the left. A component less than 50 indicates a cross wind blowing the projectile to the right. Range and deflection components of the wind in reference numbers from the wind component indicator are transmitted to the range correction board and deflection board, respectively. These boards employ the same refer-

ence number systems in determining corrections for wind. (See par. 84.)

■ 62. RANGE CORRECTIONS.—*a.* Range corrections are determined in percent of range to the nearest one-tenth of 1 percent. To avoid the use of plus and minus values, a reference number system is employed using 300 as normal. Values of reference numbers extend from 100 to 500 which allow a maximum correction of plus or minus 20 percent from normal. Numbers less than 300 indicate a down correction, and numbers greater than 300 indicate an up correction. Given a correction in reference numbers, the amount and

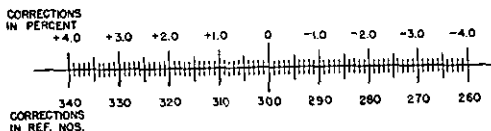

FIGURE 44.—Range correction reference number scale showing corresponding corrections in percent.

direction of the correction in percent are determined by subtracting 300 (the normal) from the reference number and pointing off one place in the result. For example, a correction of 382 indicates a correction of $382 - 300 = +8.2$ percent (up); or a reference number of 236 indicates a correction of $236 - 300 = -6.4$ percent (down). The typical range correction scale in reference numbers and corresponding corrections in percent are shown in figure 44.

b. This system is employed on the range correction board M1A1 (par. 85), and the percentage corrector M1 (par. 94).

CHAPTER 9

PREDICTION AND PLOTTING BOARD ACCESSORIES

	Paragraphs
SECTION I. Prediction.....	63
II. Plotting board accessories.....	64-70

SECTION I

PREDICTION

■ 63. LOCATION OF SET-FORWARD POINT.—*a.* During the time between the instant of observation on the target and the instant of firing the gun with data based on that observation (dead time), the target will have traveled a certain distance. During the time between the firing of the gun and the impact of the projectile (time of flight), the target will have traveled an additional distance. In order to hit the target, it is necessary to determine the travel (both in distance and direction) during the time between the instant of last observation and the instant of impact (dead time plus time of flight). The calculated position of the target at the moment of impact of the projectile is called the set-forward point. In order to locate the set-forward point, it is necessary to determine the probable path of the target during the dead time plus the time of flight. Since it is impossible to predict how a target will maneuver, it is necessary to predict along a straight line, assuming the target will travel in the same direction and at the same speed as during the measuring interval. (See appendix IV on maneuverability of naval targets.) In order to determine the distance the target will travel during the time between the instant of last observation and the instant of impact, it is necessary to determine the rate of travel and the elapsed time. The rate of travel is determined by measuring the distance (X) traveled during a measuring interval (M) and dividing this distance by the measuring interval. The elapsed time is determined by adding the dead time to the time of flight. The dead time depends upon the timing

of the position finding system (see ch. 6). The time of flight depends upon the range to the set-forward point. It can be determined quite accurately by successive approximations, but to save time in actual practice the time of flight to the last set-forward point is used. The rate of travel $\frac{X}{M}$ multiplied by the elapsed time $(t+D)$ will give the distance (Y) traveled between the instant of last observation and the instant of impact of the projectile.

b. To summarize, the problem is as follows:

Let M = measuring interval in seconds, which is usually equal to one or two observing intervals

X = number of units of travel during time M

$\frac{X}{M}$ = rate of travel (units/second)

Y = travel during time of flight plus dead time
(same units as X)

t = time of flight (seconds)

D = dead time (seconds)

In order to solve for travel from the last plotted point to set-forward point, or the distance Y , the following equation (distance = rate \times time) is set up:

$$Y = \frac{X}{M} (t + D)$$

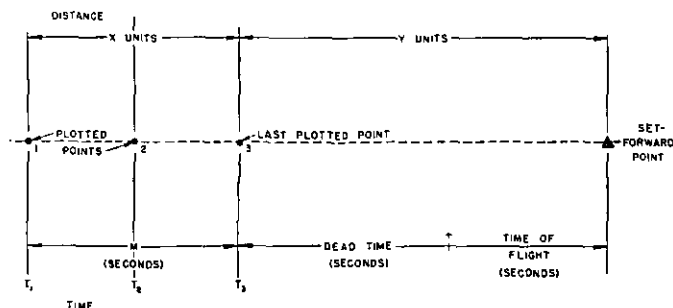

FIGURE 45.—Problem of prediction.

SECTION II

PLOTING BOARD ACCESSORIES

■ 64. GENERAL.—There are two ways of determining the travel during the time of flight plus the dead time: by means of the set-forward scale; by means of the set-forward rule and prediction scale. The set-forward chart, formerly used by some batteries, is now considered obsolete.

■ 65. SET-FORWARD SCALE.—*a. Description.*—To enable the plotting of the set-forward point by a single operation, a series of scales is sometimes constructed. These are called "set-forward scales." Each scale of the series has upon it two sets of graduations with a common zero. The scale to the left of zero is graduated in reference numbers to any convenient scale (not necessarily the same as the plotting board) and represents the travel of target X . The scale to the right is graduated to a scale $\frac{(t+D)}{M}$ times as large and represents the values of Y for corresponding values of X . Theoretically, a separate scale should be constructed for each value of t to the nearest second. In practice, however, a complete set would include scales covering times of flight, usually in 2-second intervals, from minimum to maximum range for any given battery. One set of scales is equally suitable for all scales of the plotting board but is suitable only for the particular values of D and M used in their construction. A series is therefore required for each D and M used. Such scales are not articles of issue and when desired must be constructed locally. If made of paper, they should, for convenient use, be cut up and pasted on metal strips and placed in a portable rack so that they are readily accessible to the plotter. The paper scales may be obtained upon request from the Coast Artillery Board.

b. Operation.—The plotter selects the proper scale, marked with the range or time of flight closest to that desired for the current range. He places the zero graduation of the scale at the last plotted point and measures on the X scale the distance corresponding to travel during the measuring

interval. He marks the set-forward point the same number of graduations ahead of the zero mark on the Y scale. Since this method of locating the set-forward point requires the service of only one man, no transmission of data is necessary. This removes the possibility of errors in transmission, speeds up the operation, and lessens the noise in the plotting room. In order to use the proper scale corresponding to the time of flight, an assistant would be needed to supply the proper scale. It is convenient to label the scales in range corresponding to the time of flight used in construction. In this case, the scale can be used only for one particular powder charge, projectile, and gun. The use of the set-forward scales introduces a new source of error because of the possibility that the wrong scale may be selected for the current range. A complete set of scales is necessary for each combination of D and M . It can be seen that this will lead to a large number of scales if more than one value of D or M is used.

■ 66. CONSTRUCTION OF SET-FORWARD SCALE.—*a.* From the formula $Y = \frac{X}{M}(t+D)$, the following ratio is found:

$$\frac{Y}{X} = \frac{t+D}{M}$$

b. If a situation is established where $D=15$ seconds, $M=30$ seconds, and time of flight = 20 seconds, then—

$$\frac{t+D}{M} = \frac{20+15}{30} = \frac{35}{30} = 1.16$$

$$\frac{Y}{X} = \frac{t+D}{M} = 1.16$$

$$Y = 1.16 \times X$$

c. Therefore, construct the set-forward side (right-hand side) to a scale 1.16 times as large as the travel side (left-hand side) or $Y = 1.16 \times X$.

■ 67. THE PREDICTION SCALE AND SET-FORWARD RULE.—*a. Prediction scale.*—(1) *Description.*—The prediction scale (fig. 47) is an instrument issued for use in measuring the linear travel of the target and, with a set-forward rule, in locating the set-forward point on a plotting board. The instrument

SET - FORWARD SCALES

OBSERVING INTERVAL • 15 SECONDS
 DEAD TIME • 15 SECONDS
 MEASURE TRAVEL DURING TWO OBSERVING INTERVALS

		TRAVEL	SET FORWARD POINT	TIME OF FLIGHT	RANGE
M • 30	D • 15	40 35 30 25 20 15 10 5	5 15 25 35 10 20 30 40	6	
M • 30	D • 15	40 35 30 25 20 15 10 5	5 15 25 35 10 20 30 40	8	
M • 30	D • 15	40 35 30 25 20 15 10 5	5 15 25 35 10 20 30 40	10	
M • 30	D • 15	40 35 30 25 20 15 10 5	5 15 25 35 10 20 30 40	12	
M • 30	D • 15	40 35 30 25 20 15 10 5	5 15 25 35 10 20 30 40	14	
M • 30	D • 15	40 35 30 25 20 15 10 5	5 15 25 35 10 20 30 40	16	
M • 30	D • 15	40 35 30 25 20 15 10 5	5 15 25 35 10 20 30 40	18	
M • 30	D • 15	40 35 30 25 20 15 10 5	5 15 25 35 10 20 30 40	20	
M • 30	D • 15	40 35 30 25 20 15 10 5	5 15 25 35 10 20 30 40	22	
M • 30	D • 15	40 35 30 25 20 15 10 5	5 15 25 35 10 20 30 40	24	
M • 30	D • 15	40 35 30 25 20 15 10 5	5 15 25 35 10 20 30 40	26	
M • 30	D • 15	40 35 30 25 20 15 10 5	5 15 25 35 10 20 30 40	28	
M • 30	D • 15	40 35 30 25 20 15 10 5	5 15 25 35 10 20 30 40	30	
M • 30	D • 15	40 35 30 25 20 15 10 5	5 15 25 35 10 20 30 40	32	
M • 30	D • 15	40 35 30 25 20 15 10 5	5 15 25 35 10 20 30 40	34	
M • 30	D • 15	40 35 30 25 20 15 10 5	5 15 25 35 10 20 30 40	36	
M • 30	D • 15	40 35 30 25 20 15 10 5	5 15 25 35 10 20 30 40	38	
M • 30	D • 15	40 35 30 25 20 15 10 5	5 15 25 35 10 20 30 40	40	
M • 30	D • 15	40 35 30 25 20 15 10 5	5 15 25 35 10 20 30 40	42	
M • 30	D • 15	40 35 30 25 20 15 10 5	5 15 25 35 10 20 30 40	44	
M • 30	D • 15	40 35 30 25 20 15 10 5	5 15 25 35 10 20 30 40	46	
M • 30	D • 15	40 35 30 25 20 15 10 5	5 15 25 35 10 20 30 40	48	
M • 30	D • 15	40 35 30 25 20 15 10 5	5 15 25 35 10 20 30 40	50	
M • 30	D • 15	40 35 30 25 20 15 10 5	5 15 25 35 10 20 30 40	52	
M • 30	D • 15	40 35 30 25 20 15 10 5	5 15 25 35 10 20 30 40	54	
M • 30	D • 15	40 35 30 25 20 15 10 5	5 15 25 35 10 20 30 40	56	
M • 30	D • 15	40 35 30 25 20 15 10 5	5 15 25 35 10 20 30 40	58	
M • 30	D • 15	40 35 30 25 20 15 10 5	5 15 25 35 10 20 30 40	60	

NOTE: ON EACH SCALE, TABULATE RANGE
 CORRESPONDING TO TIME OF FLIGHT.

M • 30 SECONDS, D • 15 SECONDS. SEE F.M. 4-15.

FIGURE 46.—Set-forward scales.

consists of a straight piece of metal with both edges beveled. Each beveled edge is graduated uniformly from the center outward in both directions with zero at the center. The graduations to the right or to the left represent the same units. The prediction scale need not be to the same scale as the plotting board with which it is to be used and may be constructed locally if necessary.

(2) *Operation.*—The plotter places the zero of the prediction scale on the last plotted point and measures the travel of the target during the time selected as the measuring interval of the battery. He calls off this travel to the operator of the set-forward rule, who calls back the distance to the set-forward point. This distance is measured on the plotting board along the prediction scale from the zero graduation (on the last plotted point) in the direction of travel of the



FIGURE 47.—Prediction scale.

target, and the target is set at this point, the set-forward point.

b. *Set-forward rule.*—(1) *Description.*—The set-forward rule is a device for determining with the aid of a prediction scale, the distance to the set-forward point by solving the equation $Y = \frac{X}{M}(t+D)$. (See par. 63.) This rule is not an article of issue and is usually constructed by the battery locally. The mechanical construction of the set-forward rule is similar to that of an engineer's slide rule. The body of the rule is divided by an undercut slot in which a slide travels. Mathematically, the rule is a logarithmic slide rule. The upper scale represents Y , the distance to the set-forward point, and is fixed to the body of the rule. It is graduated logarithmically in reference numbers from 100 to 4,000, with the log of 100 as the origin. Note that the scale is also labeled in parentheses in values of one-tenth of these values. These values are used for slow-speed targets. Values of X are represented on a logarithmic scale (graduated the same as Y scale), which is mounted on the movable slide. A pointer,

called a "range pointer," is attached to the X scale. The lower scale, fixed to the body of the rule below the X scale, represents logarithms of the factor $\frac{t+D}{M}$. This scale, known

as the range scale, is labeled in ranges corresponding to times of flight as determined from the proper firing tables.

(2) *Operation.*—Before tracking, the rule is "zeroed" by placing the range scale below the X scale so that the zero graduation is opposite the range pointer when the X and Y scales indicate the proportion $\frac{Y}{X} = \frac{D}{M}$. When tracking com-

mences, the operator of the rule positions the sliding X scale so that the range pointer is opposite the approximate range on the range scale called off by the plotter. When the plotter begins predicting, he measures the travel of the target during the measuring interval with a prediction scale and calls off this travel to the set-forward rule operator. The set-forward rule operator locates this travel on the X scale, and opposite it on the Y scale, reads off the distance to the set-forward point.

■ 68. CONSTRUCTION OF SET-FORWARD RULE.—*a.* When the X and Y scales are in coincidence, and $D=M$, the range pointer should be on the zero of the range scale corresponding to a time of flight of zero. If the sliding X scale is displaced until the range pointer coincides with a particular range graduation, the slide will have been displaced a distance equal to the logarithm of the the factor $\frac{t+D}{M}$. Since, in the zeroing position, the X and Y were coincident throughout their length, if the X scale is displaced an amount equal to the logarithm of $\frac{t+D}{M}$, opposite any value of X will be found a corresponding value of Y equal to $\frac{t+D}{M} \times X$.

b. The following example shows the method of constructing a range scale for a set-forward rule for a 155-mm gun

(FT 155-B-5) firing shell, HE MK III, fuze PD M46, normal charge, to meet the following conditions:

Dead time_____ 40 seconds.

Observing interval____ 20 seconds.

Measuring interval___ 40 seconds (two observing intervals).

Graduate every 500 yards and label every 1,000 yards from 0 to 14,900 yards. Scale factor is 1 log unit=15 inches.

(For illustration, the construction will be shown from 0 to 5,000 yards.)

Range	t_f	$\frac{t+D}{M}$	$\log \frac{t+D}{M}$	Scale factor $\times 15$ (inches)
0	-----	-----	-----	0.00
500	0.8	1.02	0.0086	.13
1,000	1.6	1.04	.0170	.26
1,500	2.5	1.06	.0253	.38
2,000	3.4	1.08	.0334	.50
2,500	4.4	1.11	.0453	.68
3,000	5.4	1.14	.0569	.85
3,500	6.5	1.16	.0645	.97
4,000	7.6	1.19	.0756	1.13
4,500	8.8	1.22	.0864	1.30
5,000	10.1	1.25	.0969	1.45

The range scale is now graduated in $\frac{t+D}{M}$ corresponding to time of flight and labeled in range. A new range scale is necessary for every new combination of gun, powder charge, and projectile because of the difference in time of flight. A new dead time (D) will necessitate the construction of a new range scale, but M can be changed without changing the range scale by moving the range pointer logarithmically in proportion to the change in M .

Example:

Scale of construction for—

$D = 40$ seconds $M = 40$ seconds

to be used for—

$D = 40$ seconds $M = 20$ seconds

If the initial location of the range pointer (indicating zero on the range scale when $\frac{Y}{X} = \frac{D}{M}$) is at 150 on the X scale, it is moved to 75 on the X scale, the proportion being $\frac{150}{75} = \frac{40}{20}$.

The rule is then operated in the normal manner.

c. Scales for various dead times and measuring intervals and labeled only in time of flight can be obtained from the Coast Artillery Board. From these scales, with the aid of the proper firing tables, range scales for a particular combination of powder charge, projectile, and gun can be constructed without resorting to the above calculations.

■ 69. TARG.—The targ is an instrument used to mark the successive positions of the target and to assist in the reading of azimuths and ranges on the board. It is wedge-shaped with a small projection at the apex for identifying the paper covering the plotting board.

■ 70. TIME-RANGE BOARD.—a. *Description.*—The time-range board is a device to permit the using of ranges obtained at irregular intervals in determining ranges to the target on the TI bell and ranges to the set-forward point. The purpose also is to smooth out readings that may be erratic due to irregularities of observation and to provide a graphical analysis of the values and trends of readings. The board consists of a base and a mechanism for moving a strip of paper across the base at a uniform speed. On the base a uniformly graduated scale arm is placed with the fiducial edge perpendicular to the direction of motion of the paper. When it is desired to furnish predicted ranges, a prediction scale also graduated in ranges is added (see fig. 50). This board is not an item of issue and if constructed locally may include many modifications. An electric motor or a hand-operated drum provided with a slow motion crank may be used for translating the paper. In the latter case, the man turning the drum should have a stop watch or watch with a large second hand so that he will be able to turn the drum the same number of revolutions per second and thus maintain a uniform rate of movement of the paper. A movement of between $\frac{1}{20}$ and $\frac{1}{60}$ inch per second should prove satisfactory.

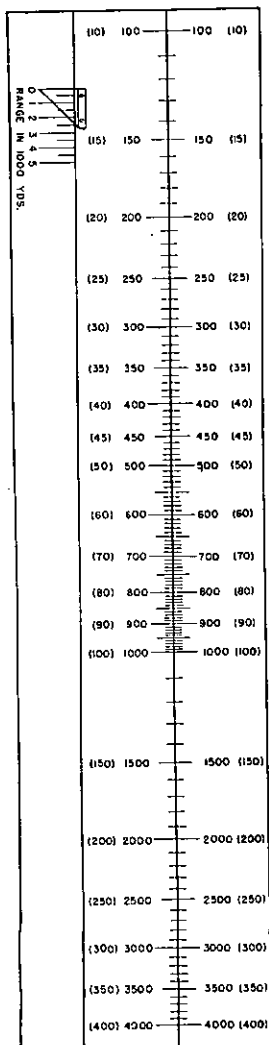

FIGURE 48.—Set-forward rule.

The base for this device may be similar to a drawing board and should be equipped with guides to insure that the moving paper follows a true path. Pins on the board might serve as guides, or shoulders might be attached to the roller pulling the paper. The range and prediction scales are graduated on the scale arm (of either metal or xylonite) to any convenient scale. A scale of 500 or 600 yards per inch will enable ranges to be plotted to the nearest 10 yards. This arm should be fastened to the board in such a position that the paper will pass under it as shown in figure 50. In order to limit the length of the scale arm needed, several interchangeable scale arms should be supplied. Each arm would be graduated for a portion of the total range of the arma-

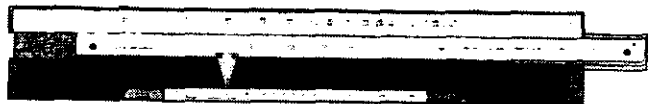

FIGURE 49.—Set-forward rule slide displaced.

ment and the scales should overlap. For example, the first scale might cover from 0 to 10,000 yards, the second from 5,000 to 15,000 yards, and the third scale from 10,000 to 20,000 yards.

b. Construction.—Figure 50 shows a typical construction of the board. The scale arm is mounted on the board with the right-hand edge perpendicular to the motion of the paper. In this case, the paper has been assumed to be moving from left to right. The range scale is graduated uniformly along the right-hand edge. The curved shape of the left-hand edge, that is, the prediction curve, can be plotted by scaling distances from and perpendicular to the right-hand edge equal to the dead time plus the time of flight for each particular range. The scale used in plotting these distances must correspond to the rate of movement of the paper. The range graduations on the prediction scale are the horizontal projections of the graduations on the right-hand edge. From the foregoing it will be seen that the distance between the right- and left-hand edges of the scale arm at any particular range graduation will represent

to scale the dead time plus the time of flight for that particular range. Any particular scale arm is good only for one particular combination of gun, powder charge, and projectile. The method of mounting the rollers and moving the paper is left to the discretion of the battery commander and will depend upon available material.

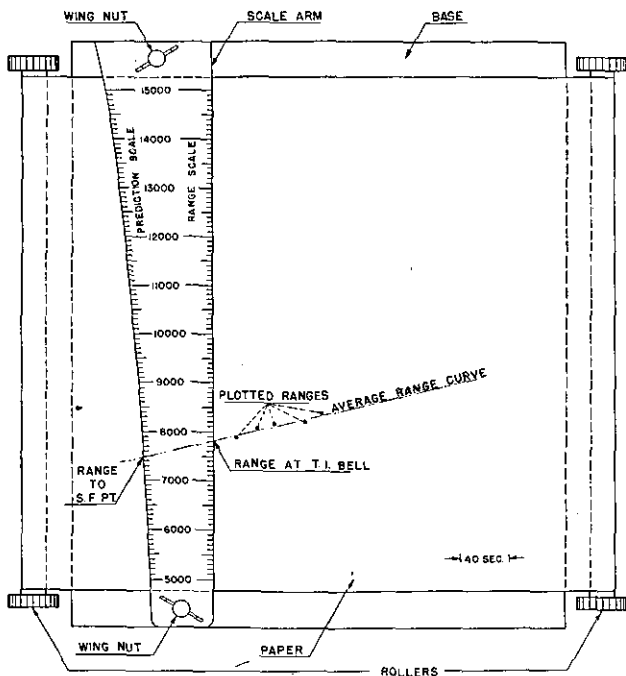

FIGURE 50.—Typical time-range board.

c. *Operation.*—With the proper scale arm in place and the paper moving at a rate corresponding to the scale for which the prediction curve is plotted, the board is ready for operation. As a range is read from the range-finder, a point is plotted against the range scale opposite the range called off. After several points have been plotted in this manner, a smooth line could be sketched in averaging these

points. If desired, a transparent straightedge could be used to indicate the average line. This average line is extended to the range scale, and when the TI bell is sounded, the range at that instant can be read directly at the intersection with the range scale. This range could then be sent to the plotting board and set on the single station arm. If it is desired, the range to the set-forward point can be determined by extending this same averaged line until it intersects the prediction scale. This would give the uncorrected range to the set-forward point.

CHAPTER 10

PLOTTING BOARDS

	Paragraphs
SECTION I. 110° plotting boards M1915 and M1918-----	71-73
II. Plotting boards M3 and M4-----	74-75
III. Plotting and relocating boards M1923 (Clove) and M1-----	76-79

SECTION I

110° PLOTTING BOARDS M1915 AND M1918

■ 71. DESCRIPTION.—*a.* These boards are for use with all types of fixed seacoast artillery. They provide means for locating the target by either the two-station or the single-station method and for locating and relocating the set-forward point in range and azimuth. The 110° plotting board M1918 is practically identical with the M1915 board except that the former is slightly larger and covers longer ranges.

b. The M1915 board (fig. 51) will be discussed in detail in this section. It represents a small scale map of the actual ground situation, the elements of the battery being accurately located with respect to each other.

c. The board proper is a wooden board on a frame supported by four wrought-iron pipe legs with provisions for approximate leveling. An azimuth circle of about 150° of arc is provided on the periphery of the frame. On this board the directing point is at the center of the azimuth circle and the gun arm is pivoted in the gun center bracket above this point. Vertical pivoting is also provided to facilitate handling the gun arm when operating the board. A circular bronze plate called the "station plate" is placed on the board with its center at the center of the azimuth circle. The primary and secondary stations are represented by sleeves placed in the station plate and located at the proper azimuth and distance from the directing point. The azimuth circle may be marked to cover any segment of the circle about the directing point. The azimuth represented by the center line

of the board may be used as a reference line in locating the station positions. Positions for auxiliary and alternate stations of the battery may also be included on the board.

d. The station arms are pivoted in sockets in the sleeves and are furnished with couplers equal in length to the displacement of the stations from the directing point. The couplers are attached to index boxes riding along the azimuth circle and keep the station arms at all times parallel to imaginary auxiliary arms pivoted at the directing point. This arrangement permits the use of the same azimuth scale for all three arms.

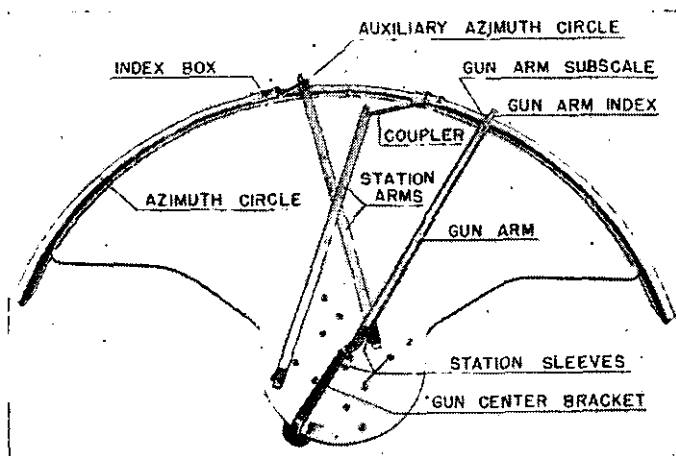

FIGURE 51.—110° plotting board M1915.

e. In order to cover 360° of azimuth, four positions of each observation station are provided in the station plate, and four rows of azimuth scales differing by 90° are marked on the azimuth circle. The quadrants are lettered *A*, *B*, *C*, and *D*; all station positions and the azimuth scale for the same quadrant are marked with the same letter. The principles involved in this arrangement are illustrated in figure 52. In this figure the normal set-up of the board is shown at the left. This is the set-up for quadrant *A* in which the center line of the board represents 180° azimuth (from south). The

positions of the station sleeves for this quadrant are shown at $B^1(a)$ and $B^2(a)$. The set-up for which the center line of the board represents a 90° azimuth is shown at the right. If the figure at the right is revolved clockwise through 90° and placed on the figure at the left, the station sleeves will fall at the positions $B^1(b)$ and $B^2(b)$. By pivoting the station arms in the latter positions and by decreasing the readings of the azimuth circle by 90° , the board will duplicate the set-up for quadrant *B*. The same provisions may be made for quadrants *C* and *D*.

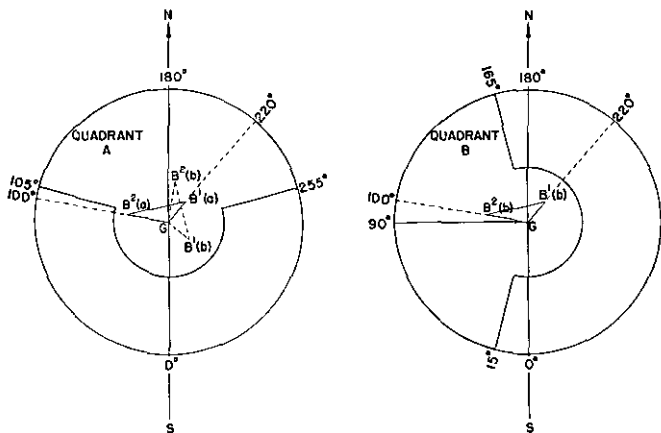

FIGURE 52.—Arrangement of quadrant positions on 110° plotting board.

f. When one or more observation stations are located so close to the directing point that the station sleeves cannot be provided without mechanical interference, all four positions for each station so located are put on a center station plug which fits into a square bushing in the station plate. An arrow on the plug pointing to the quadrant letter on the station plate indicates the quadrant position being used. To change quadrants, remove the plug and replace it in the desired position.

g. Azimuths of the station arms are read by means of the index boxes attached to the couplers. Degrees of azimuth

are indicated on the azimuth scale; hundredths of a degree are indicated on a subscale on the index box. Two subscales are provided on each index box, one engraved and filled in in black, and the other in red. The black subscale is the normal one for use and indicates the azimuth of the imaginary auxiliary arm and, therefore, of the station arm. The red subscale is for use when the target is in such a position that the station arm or coupler covers the black subscale. It indicates an azimuth 3° greater or less than that of the arm, according to whether it is to the right or to the left of the black subscale looking from the center of the board. The gun arm is provided with a single subscale. The least reading on the subscales is 0.05° . There are four holes in the gun arm index immediately over the four azimuth scales on the azimuth circle. The azimuth scale being used is indicated by placing the index pin in the proper hole.

h. An auxiliary azimuth circle, graduated in degrees, is riveted to each coupler in such a position that when oriented the beveled edge of the station arm will indicate on the auxiliary scale the azimuth of that arm to the nearest degree.

■ 72. ORIENTATION.—*a.* The station sleeves are placed and the azimuth scales oriented by Ordnance Department personnel before the board is issued to the using battery. The only orientation necessary at the battery involves selecting the proper station arms with their couplers, determining the quadrant most suitable for the position of the target, placing the station arms in the proper sleeves for that quadrant, positioning the coupler, and inserting the index pin in its proper hole in the gun arm index. The coupler must be parallel to the line, directing point station sleeve.

b. The auxiliary azimuth circles at the end of the arms are used to check the position of the coupler in orientation. If the arm is pivoted in the station sleeve stamped $B^1(a)$, as an example, the azimuth appearing in the index box on the set of graduations marked for quadrant A should be the same, to the nearest degree, as that indicated along the beveled edge of the arm on the auxiliary azimuth circle. If it does not check, disconnect the coupler from the index box and turn to the position in which the auxiliary azimuth

circle indicates approximately the same azimuth as the reading in the index box. Reconnect the coupler to the index box.

■ 73. OPERATION.—This board has no special device for the determination of angular travel, other plotting room devices having been adapted to the use of azimuths of successive plotted (or set-forward) points in determining the angular travel of the target for case II pointing. Therefore, the operation of the board for case II pointing and the operation for case III pointing are identical. The steps in the operation are as follows:

a. *Horizontal base.*—(1) *Tracking.*—Each arm setter wears a telephone head set connected to the reader at the corresponding observation station. He receives the azimuth of the target as called out by the reader at the sounding of the TI signal and sets his station arm to that azimuth, repeating the azimuth back to the reader. When his arm is properly set, he calls, "Set." (To reduce confusion in the plotting room, it is often preferable not to have the arm setter repeat the azimuth, but to have the reader repeat the hundredths of a degree of azimuth.) When both arm setters have called, "Set," the plotter places the targ accurately at the intersection of the station arms and marks on the plotting board the position of the plotted point. He then calls or signals, "Clear," upon which the arm setters move their station arms away from that part of the board to give the plotter space in which to work. This operation is repeated for each plotted point.

(2) *Location of set-forward point.*—After at least two, and preferably three, plotted points are located, a set-forward point may be located. The plotter estimates the expected course of the target and places the edge of the prediction scale along that line with the zero at the last plotted point. He calls out to the set-forward rule operator the travel of the target during the measuring interval (see ch. 9), as is indicated by the plotted points. The set-forward rule operator calls out the travel during time of flight plus the dead time. The plotter then marks with the targ the position of the set-forward point along the edge

of the prediction scale at the proper distance ahead of the last plotted point. This operation is repeated for each set-forward point.

(3) *Relocation.*—When the first set-forward point is located, the gun arm is swung against the targ held at that point and the plotter reads the uncorrected range to the set-forward point from the range scale on the gun arm, and one of the arm setters reads the azimuth to the set-forward point from the index box at the end of the gun arm. The plotter then places a small triangle around the point as a distinguishing mark to avoid confusion with later plotted points. This operation is repeated for each set-forward point and follows immediately after the location of the set-forward point. For horizontal base tracking with prediction scale and set-forward rule, the personnel consists of the plotter, two arm setters, and a set-forward rule operator. The azimuth of the set-forward point is read by one of the arm setters.

b. Vertical and self-contained bases.—When using either a vertical or self-contained base system or radar, only one arm setter is required. This arm setter receives the range and azimuth to the target from the observation station. He sets the station arm to the azimuth and calls off the range to the plotter who plots the point along the station arm at the proper range. The operation of the plotting board is the same as described for the horizontal base system.

c. Predicting by set-forward scales.—When predicting by set-forward scales, the set-forward rule and its operator are no longer necessary. In this case the plotter locates the set-forward point as described in paragraph 65 and proceeds to the determination of the uncorrected firing data.

SECTION II

PLOTTING BOARDS M3 AND M4

■ 74. *DESCRIPTION.*—*a.* The plotting boards M3 and M4 are designed for use with all types of fixed guns of 6-inch caliber and larger. They provide a means for locating the target by either the two-station (horizontal base) or the one-station

(vertical or self-contained base) method. The methods of locating and relocating the set-forward point in range and azimuth and determining the angular travel are the same as those employed with the 110° plotting board M1915. The M3 and M4 boards are similar to the M1915 and M1918 plotting boards but have an azimuth circle and a plotting surface covering the whole seaward field of fire of the batteries to which they are assigned.

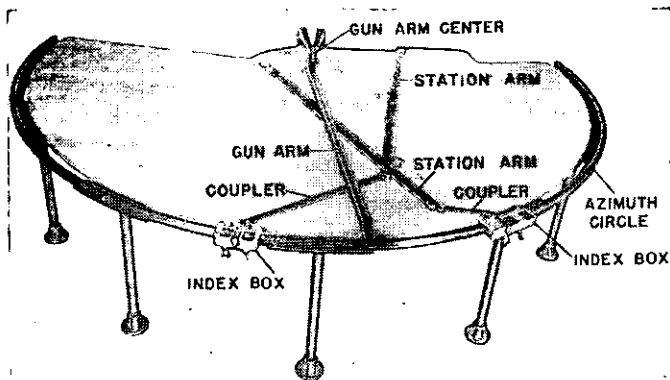

FIGURE 53.—Plotting board M3.

b. The plotting boards M3 and M4 differ essentially from the 110° board in that they permit continuous plotting through a field of about 200° , the center line of which corresponds approximately in azimuth with the center line of the field of fire of the gun. The M3 and M4 boards are equipped with optical station arms in addition to the mechanical arms, and each station is located in only one quadrant since the board represents in size the whole seaward field of fire. The general theory of these boards is identical with that of the 110° board.

c. The plotting board M3 is constructed to a scale of 500 or 600 yards per inch. It has a plotting radius of $58\frac{1}{3}$ inches, and the station and gun arms are graduated from 2,000 to 29,000, or 3,000 to 35,000 yards, depending on the scale of the board. The plotting board M4 is constructed



4. Optical station arm.

21. Normal subscale.

22. Auxiliary subscale.

17. Elbow telescope.

FIGURE 54.—Plotting board M3 (or M4)—showing gun arm, mechanical arm, optical station arm, and index box.

to a scale of 800 yards per inch. It has a plotting radius of $67\frac{1}{2}$ inches, and the station and gun arms are graduated from 4,000 to 54,000 yards. As the boards differ only in plotting radius and range, the descriptions apply to both boards unless otherwise noted.

d. Optical arms are used for those stations whose distance from the directing point would make a long coupler necessary if a mechanical arm were used. Ordinarily, optical arms are used where the distance between the *DP* and the station plug is 25 inches or more. When both arms are mechanical arms, the operation is essentially the same as on the 110° board, as the azimuths to the target from the base-end stations are set on the large azimuth circle by means of index boxes. When there are a mechanical arm and an optical arm, the mechanical arm is set as on the 110° board and the azimuth for the optical arm is set by the method described in the paragraphs below.

■ 75. THE OPTICAL STATION ARM.—*a.* The optical station arm eliminates the inconvenience and interference attending the use of the conventional coupler assembly with stations located 25 inches or more from the directing point.

b. The number of optical station arms supplied with each board depends on the number and location of the stations. The arms are interchangeable among the stations so that, ordinarily, no more than two standard arms are needed. However, on certain boards, stations have been located in front of the directing point, and in these cases special arms are supplied which are not interchangeable with the standard arms. (See *f* below.)

c. The optical center is mounted on the board in a position corresponding to the location of one base-end station. At the optical center, there is mounted a vertical mirror which can be rotated about a vertical axis. Underneath the vertical mirror is a worm gear connected by a tube to an azimuth handwheel which rotates the mirror. On the indicator attached to the handwheel is indicated the azimuth of a line (the fiducial edge of the arm) which makes a constant angle with the normal to the mirror.

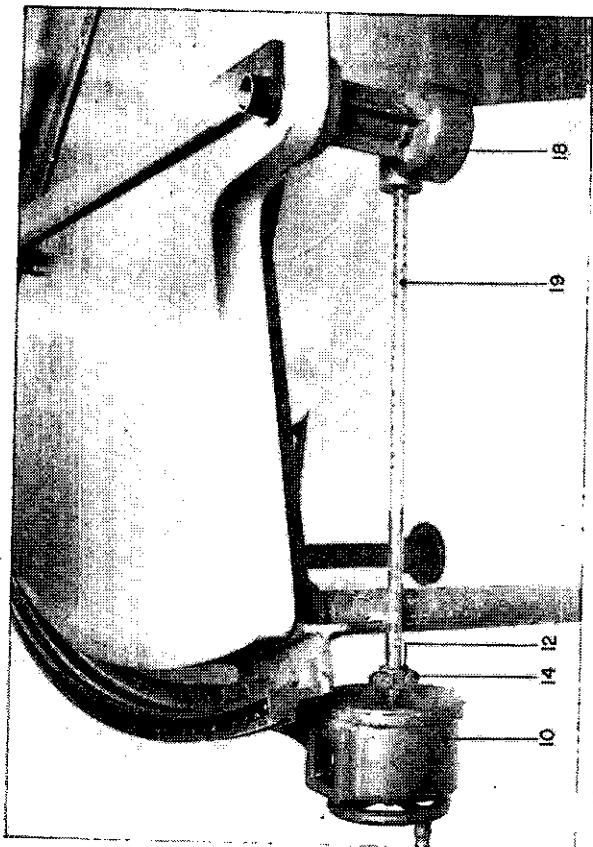

10. Azimuth indicator.
12. Adjustable coupler.

14. Worm.

18. Mirror drive housing.

19. Tube.

FIGURE 55.—Plotting board M3 (or M4), azimuth indicator and mirror drive.

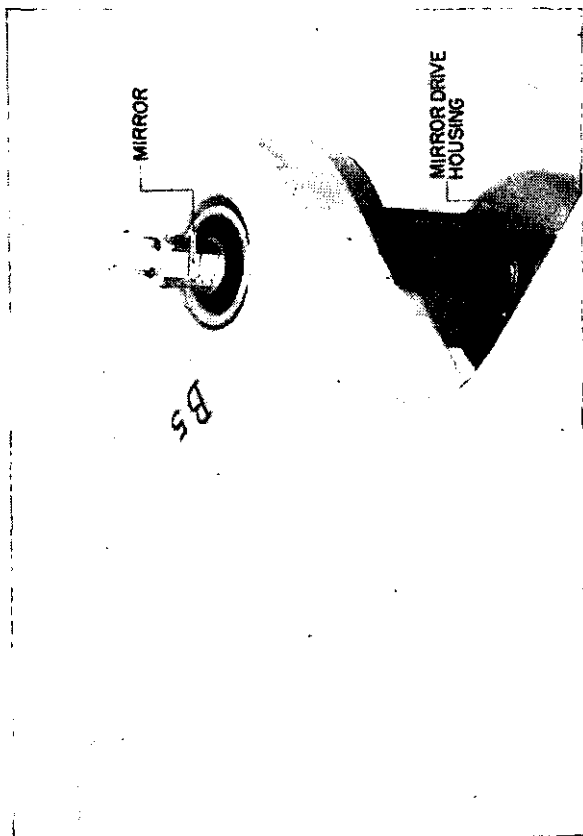

Figure 56.—Mirror assembly.

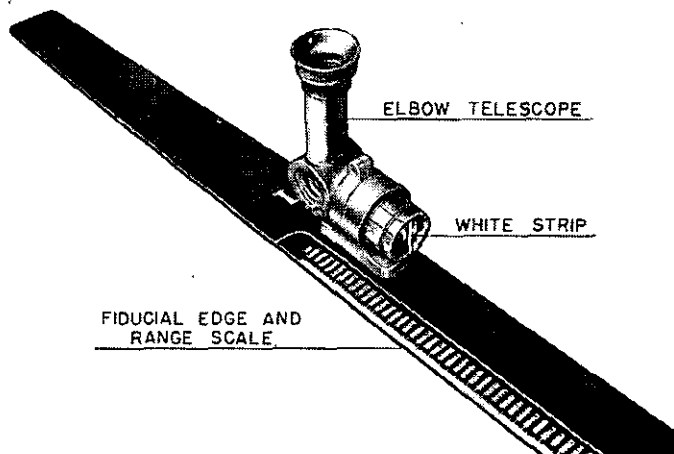

FIGURE 57.—Optical station arm (elbow telescope end).

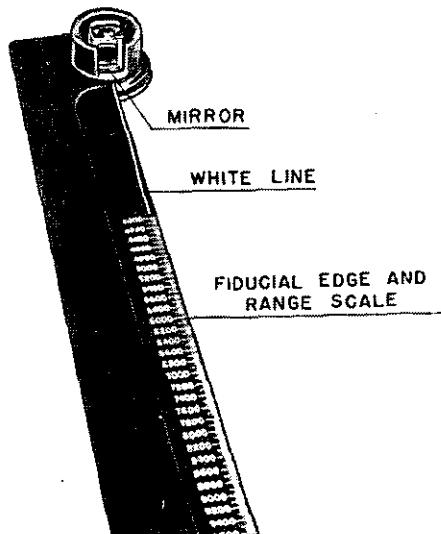
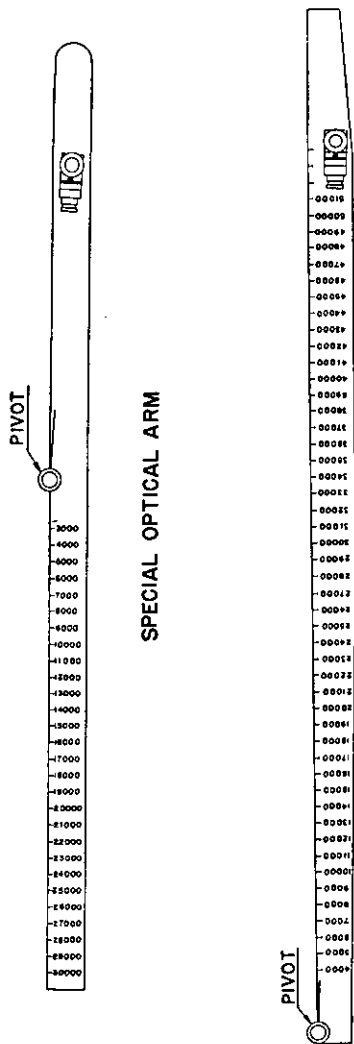

FIGURE 58.—Optical station arm (mirror end).

d. On the optical station arm near the pivot sleeve is found a short white line which makes a small constant angle (see *c* above) with the fiducial edge of the arm and is parallel to the line of sight of the elbow telescope (fig. 57). The optical station arm which is pivoted on the optical center is then rotated until this white line is normal to the mirror. The white line is normal to the mirror when its reflection in the mirror appears to be a prolongation of the line itself. Since the naked eye cannot accurately determine when the above condition exists, the arm can only be set approximately by this method. To permit a more accurate setting in azimuth, a right-angled or elbow telescope is attached to the outer end of the optical station arm and sighted on the vertical mirror. A cap fits over the objective cell of the telescope and supports a narrow, vertical metal strip, the front surface of which is painted white. In use, the arm is positioned with respect to the mirror until the vertical black line on the reticle of the telescope appears to be superimposed upon the reflected image of the white metal strip supported by the above-mentioned cap. This condition will prevail only when the line of sight is normal to the mirror. In this position, the fiducial edge of the arm will be set to the azimuth indicated on the azimuth indicator, which is connected to the mirror.

e. On the M3 and M4 boards, two optical arms may be used. In this case both are operated as explained in *d* above. Once the arms are set, the operation of these boards is identical with the 110° board. A more detailed explanation of these boards appears in TM 9-2681.

f. In addition to the standard optical station arms, a battery sometimes employs a special optical station arm. When a station is located some distance in front of the directing point, the special optical arm must be used. The pivot point of a special arm is somewhere along the arm, as shown in figure 59, while on the standard arm the pivot is at one end and the telescope at the other. The distances between the telescope and the pivot point of the special arms are such that the sighting of the white line through the telescope is convenient. On the standard arm, the range scale increases from the pivot toward the arm setter, while on



STANDARD OPTICAL ARM
 FIGURE 59.—A comparison of the standard and special optical station arms.

the special arm the range scale increases from the pivot away from the arm setter, representing a line of sight away from the operator. Figure 60 represents the intersection of a mechanical arm with a special optical arm.

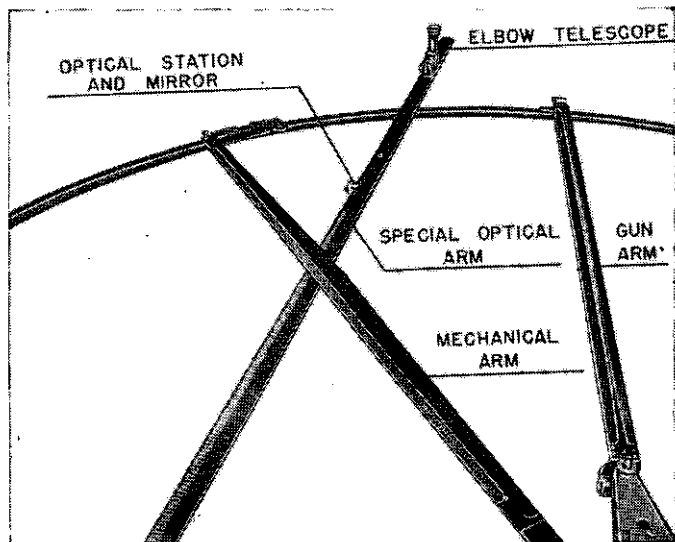

FIGURE 60.—Intersection of special optical arm with mechanical arm.

SECTION III

PLOTTING AND RELOCATING BOARDS M1923 (CLOKE) AND M1

■ 76. DESCRIPTION OF M1923 (CLOKE) BOARD.—*a.* The plotting and relocating board M1923 (see fig. 61), is for use with all types of mobile and fixed seacoast artillery.

b. The 110° board and similar types are satisfactory for guns on fixed emplacements but have no provisions for readily changing the position finding set-up. Since the lay-out of a mobile battery is different for each position occupied, a suitable plotting board for mobile seacoast artillery must provide

means for readily setting up and as readily changing any selected arrangement, within wide limits, of observation stations, directing point, and field of fire. The M1923 board provides these means. This board also provides means for relocation of the set-forward point from any point in the vicinity of the directing point.

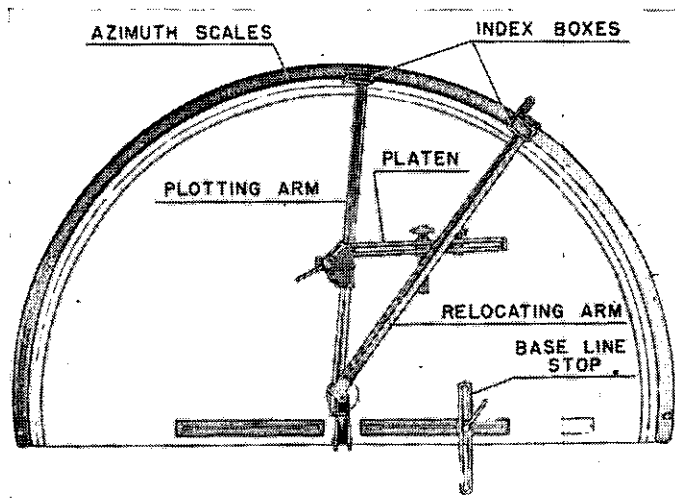

FIGURE 61.—Plotting and relocating board M1923 (Clove).

c. The M1923 board has a wooden base with an azimuth circle of 188° of arc along the periphery. The azimuth scale is marked on metal strips that fit in a slot in the azimuth circle and may be removed readily and replaced. Markings for both mils and degrees are provided.

d. Two arms, one referred to as the plotting arm and the other the relocating arm, are pivoted at the center of the azimuth circle. The arms are set in azimuths by means of subscales at their outer ends. The least readings of the subscales are 1 mil and 0.05° . Each arm is provided with range graduations on its reading edge and with four sets of removable range scales so marked that the scale of the

board may be made any one of the following: 300, 600, 750, 900, or 1,200 yards to the inch.

e. The position of the target is indicated by the intersection of the arms at the center of the board. If the target is moving clockwise as viewed from the directing point, the directing point will appear to move clockwise about the target as viewed from the target. The target is assumed to be standing still and the apparent movement of the directing point is plotted, and its relative motion about the target is used to determine the firing data. The base line is also considered as moving with the directing point about the target. Provision is made for maintaining the azimuth of the base line as it is moved.

f. The base line is represented on the platen, a movable plate pivoted to a slide which fits over the plotting arm. The platen pivot remains coincident with the reading edge of the plotting arm and coincides with the center of the azimuth circle when the slide is pulled against its stop at the inner end of the plotting arm. A clamp on the platen, when tightened, prevents rotation of the platen about its pivot. One observation station is represented by a push button at the platen pivot. The other station is represented by a push button that is placed in the master key. The fiducial edge of the master key is directly above the push button. The master key is carried on a slide on the platen and may be positioned along the platen at any distance away from the pivot (representing the other station). There is no mechanical connection between the platen and the relocating arm.

g. The directing point is represented by the gun push button which is fastened to the platen by a double slide, allowing adjustment of the gun push button either parallel to or perpendicular to the platen. Figure 62 shows the gun push button in position.

h. The M1923 board solves mechanically the position finding triangle, the apexes of which are the target, and the two base-end stations, thus locating the target with respect to the base line. See figure 64 for example showing relation between the plotting board and the situation on the ground. The target is then relocated with respect to the directing

point. Because of the assumption that the target is at the center of the board, the azimuths set on the azimuth scale are read from the outside in. The reason for this will be apparent upon examination of figure 63. In this figure, the azimuth from B^1 is 200° and the azimuth from B^2 is 145° , as shown in the circles around B^1 and B^2 . The azimuths of B^1T and B^2T also could be read on the dotted portion of the circle around the target T . However, the plotting board

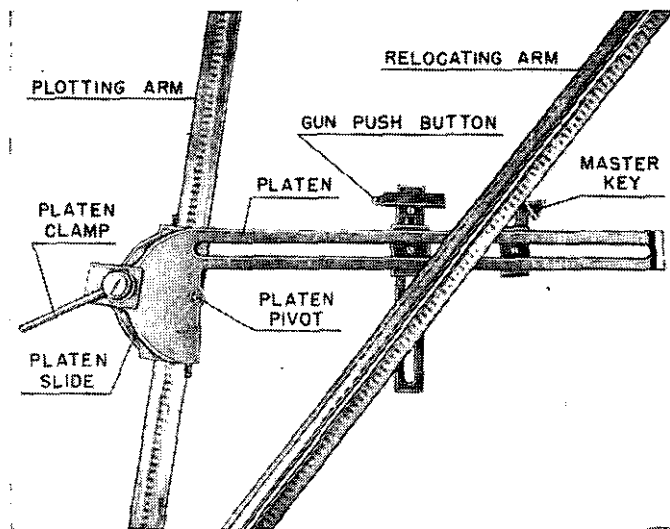

FIGURE 62.—Platen in plotting position.

reproduces only the lower half of the circle around the target, each arm corresponding to an arrow. Azimuths must therefore be read from the lower half of the azimuth circle at the end of each arrow. The azimuth of the arrow in figure 63 is indicated by the reading at the circle. Similarly, the azimuth of each arm on the M1923 board is indicated by reading the azimuth circle and subscale in the index box on the end of the arm. Provision is made for changing the direction of the arms without disturbing the orientation of the base line which is maintained parallel to

its original position while the arms are being moved. Sometimes by shifting the center of the field of fire away from the center of the board, the base line can be placed in a position that permits its orientation by the ordinary method described herein. This, however, should not be attempted if

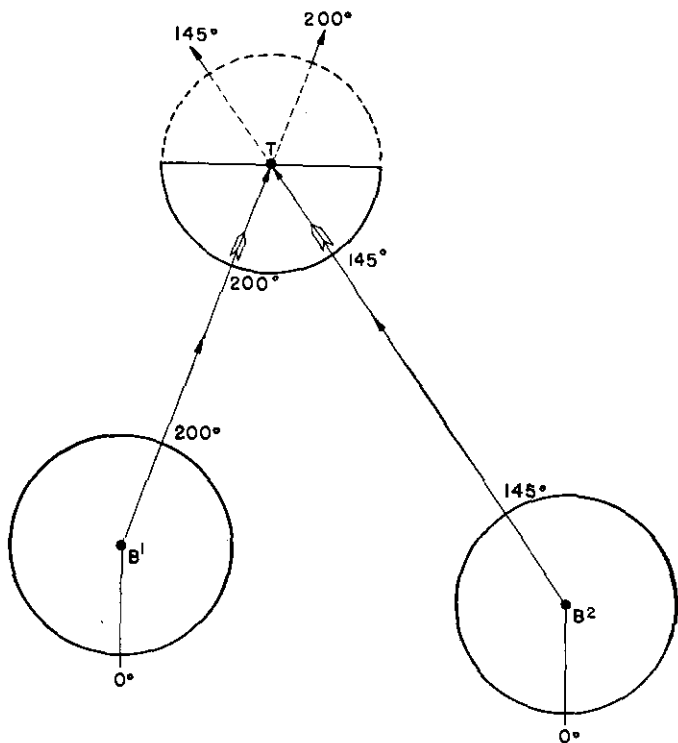

FIGURE 63.—Measurement of azimuth on plotting and relocating board M1923.

it will place a portion of the field of fire beyond the limits of the board.

i. In figure 63, assume that an observer at B^1 and one at B^2 are sighting on a target at T . To each of them the target

would appear at the azimuth indicated. Suppose that an azimuth circle were drawn around the target. The lines would intersect at the center of the circle and the azimuth of each line would be as shown on the edge of the circle. If a line is drawn through the circle, passing through *T*, the lower half of the circle would duplicate the plotting board M1923, each line representing an arm. Each arm represents, in this position, a line of sight from a station to a target or board center. Notice that the azimuths increase clockwise, even though they represent azimuths from the outside toward the center.

j. (1) In order that the platen may be maintained in its proper relation to the azimuth circle during operation of the board, two provisions are necessary:

(a) To set the arms in azimuth without changing the azimuth of the platen (base line).

(b) To readily "reorient" the platen or return it to its original azimuth while the arms are positioned to new data.

(2) The first provision is made possible by sliding the platen along the plotting arm until it rests against the stop at the end of that arm. The platen pivot is then coincident with the center of the board around which the arm also pivots. Thus, if the platen clamp is loosened, the plotting arm may be moved without causing any movement of the platen. Since there is no mechanical connection between the relocating arm and the platen, movement of that arm is independent of the platen. The second provision is accomplished by the base line stop. This is a brass stop which is clamped in such a position that when the platen rests against it and the stop on the plotting arm, the base line is at its proper azimuth. At any time the platen is brought against the two stops while the platen clamp is loosened, it will be reoriented. If the unclamped platen is brought against the stops and the plotting arm is set and held stationary, the platen can then be clamped to the slide so that when the slide is moved out along the plotting arm the base line will move parallel to itself, thus maintaining the proper relation to the azimuth circle.

k. The method of determining the proper position along the plotting arm at which to stop the platen when plotting

depends on the method of target location used, whether two-station or single-station. In the two-station method, the arms are set to the azimuths received from their respective stations by the arm setters, and the platen is moved out by the platen operator until the master key touches the re-

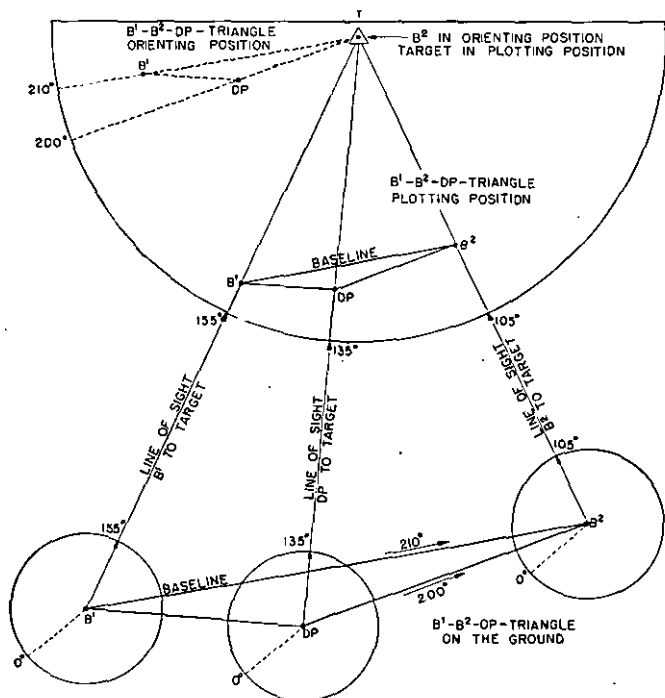

FIGURE 64.—Relation of position finding triangles on ground and on plotting and relocating board M1923.

locating arm; in the single-station method, the plotting arm is set to the azimuth received from the observation station, and the platen is moved out until the range is indicated on that arm by the index on the platen slide.

■ 77. ORIENTATION OF M1923 (CLOKE) BOARD.—*a. Base line and azimuth circle.*—The operation of orienting presents the

same problem on the M1923 board as on all other plotting boards; that is, placing the base line in its proper angular relation with respect to any selected radius of the azimuth circle and locating the base-end stations and the directing point with respect to each other. There is, however, an additional step required in orienting the M1923 board; that is, the establishment of an orienting position at which the platen may be readily reoriented during plotting.

(1) *Selection of azimuth scales.*—The first consideration is the selection of the azimuths to be covered by the board. The usual procedure is to put the azimuth of the center of the field of fire as close as possible to the center line of the board. This may be done by sliding the metal strips of the azimuth scale around the circle until the desired azimuth marking is at the center of the arc. In case it is desired to set up the board for the simultaneous use of mils and degrees, there is one precaution to be observed. At the reference line (zero) of any azimuth circle and at each multiple of 9° of azimuth the full mil and degree graduations coincide. On the M1923 board these points are indicated on the azimuth circle by longer lines than those at other points. Azimuths that are multiples of 9° should be set at the longer lines.

(2) *Selection of observation station positions.*—The next consideration is the selection of positions to represent the observation stations. On the M1923 board the positions of the observation stations, such as B^1 and B^2 , and of the DP. are represented on the platen. The board may be set up for operation with the platen and the relocating arm on either side of the plotting arm; either station may be located at the platen pivot. As a general rule, the more convenient arrangement is to put at the platen pivot the station more distant from the directing point. Occasionally, there are, however, practical considerations which dictate the choice of positions. Sometimes the position finding set-up is such that the mechanical construction of the board limits the choice of positions in orienting. If the orientation is prevented by mechanical interference, reverse the platen and station positions and reorient. A little experience in the use of the board will be of assistance in

selecting the arrangement most convenient for orienting and plotting. Another factor which may influence the selection of positions is the location of an observation instrument for vertical base. If a vertical base system is used, the station must be on the plotting arm, that is, at the platen pivot.

(3) *Selection of pivot holes and indexes.*—When setting up the board, care should be taken to see that the proper pivot holes on the arms are used. There are two pivot holes on each arm corresponding to the two edges of the arm. The hole used should be on the same side of the arm as the edge used. On the plotting arm, the edge used is the edge coincident with the platen pivot, while on the relocating arm, the edge used is the edge against which the master key makes contact. The index boxes are equipped with flaps to cover up the scales not in use. One flap covers the mil or degree scale. There are four small flaps covering the degree and mil subscales. The proper subscale used is the one on the same side of the edge being used. All flaps are marked either mils or degrees to indicate which scale or subscale has been exposed. When changing from one edge of the relocating arm to the other edge, it is necessary to change over the range scale at the same time.

(4) *Ordinary orientation (by azimuth and length of base line).*—Because of its flexibility, the M1923 board may be orientated in several ways. The ordinary method of orientation is by use of the azimuth and length of the base line. This method should be used whenever possible because it is more accurate than either of the other methods. The method is illustrated in figure 65. In this set-up, the platen pivot has been selected to represent B^2 and the master key to represent B^1 . The azimuth of the base line is 107° , and its length is 6,000 yards. The procedure is as follows:

(a) Release the platen clamp and slide the platen along the plotting arm until the slide touches its stop at the inner end of the plotting arm. This brings the platen pivot over the center of the azimuth circle. The azimuth at which the plotting arm is set is immaterial.

(b) Set the relocating arm at the azimuth of the base line and clamp it. According to the rule, the azimuth set is that from the outside to the center of the circle, or from

the station represented by the master key to the station represented by the platen pivot—in this case, from B^1 (at the master key) to B^2 (at the platen pivot).

(c) To locate B^1 , loosen the master key and slide it along the platen until it lies along the reading edge of the relocating arm opposite a reading equal to the distance B^1 to B^2 . Clamp the master key in place.

(d) Holding the platen slide against its stop, swing the platen about its pivot until the edge of the master key is against the reading edge of the relocating arm and tighten the platen clamp. The platen is now oriented. **Caution:** Be sure that there is no play of the platen caused by not bringing the platen stop to full contact and also, that too great a pressure is not exerted against the relocating arm, resulting in an incorrect azimuth of the base line.

(e) With the platen slide still against its stop, bring the base line stop against the edge of the platen and clamp the base line stop. This establishes the orienting position for the platen for use in plotting.

(5) *Orientation by datum point.*—This method is of particular value in orienting a board for an alternate set-up in which the azimuth and length of the alternate base line are not known. By this method, the platen may be oriented for any two observation stations from each of which the azimuth and range to a point in the field of fire are known. This method also is illustrated in figure 65. The procedure is as follows:

(a) Set and clamp each arm at the azimuth from the station it represents to the datum point.

(b) Release the platen clamp and the slide holding the master key and slide the platen along the plotting arm until the index on the slide is set at the range from the station represented by the platen pivot (in this case B^2) to the datum point.

(c) Holding the platen slide at that range, swing the platen about its pivot and move the master key along the platen until the master key touches the relocating arm at the range from the station it represents (in this case B^1) to the datum point. Clamp the platen to the slide and the master key to the platen. The platen is now oriented.

(d) Slide the platen along the plotting arm until the slide touches its stop at the center of the circle; bring the base line stop against the edge of the platen and clamp the base line stop. This establishes the orienting position for use in plotting.

(6) *Orientation by equilateral triangle.*—This method may be used when, for ease in plotting, it is desired to represent

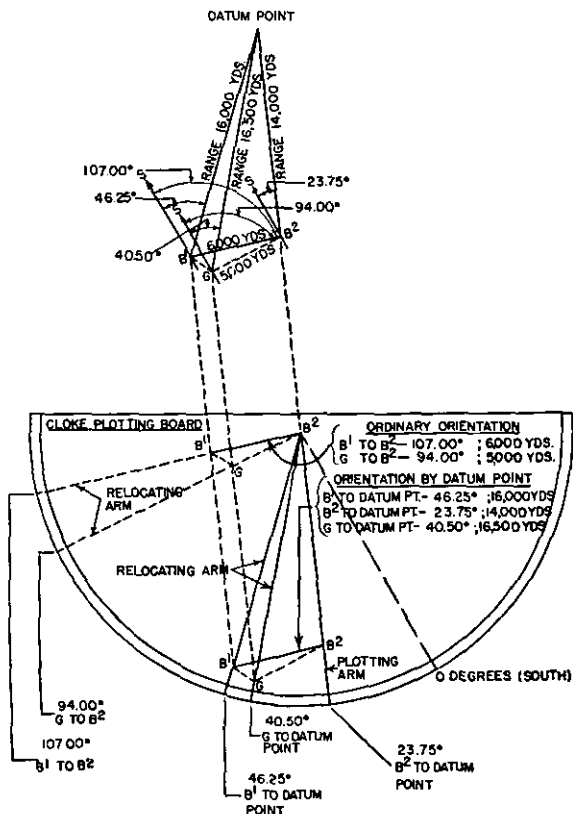

FIGURE 65.—Orientation of M1923 board (also M1)—ordinary and datum point methods.

a particular station at the platen pivot, and the azimuth from the station represented by the master key to the station represented by the platen pivot cannot be set on the board. For example, if in the situation shown in figure 65, B^1 were at the platen pivot and B^2 at the master key, the azimuth for use in the ordinary method of orientation would

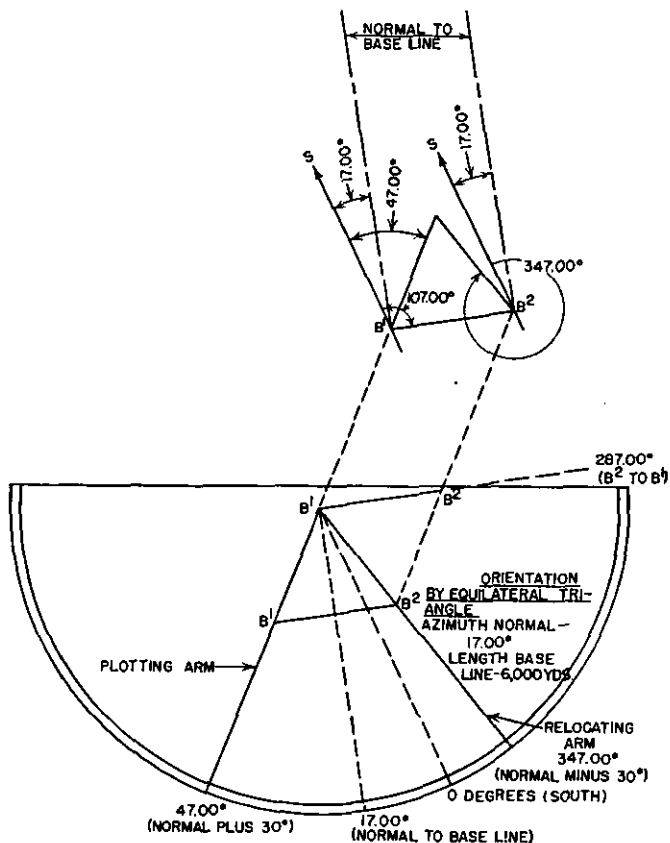

FIGURE 66.—Orientation of M1923 board (also M1)—equilateral triangle method.

be 287.00° . This azimuth is not included in the semicircle on the board. This method is illustrated in figure 66. This is the original set-up with the platen and the relocating arm on the opposite side of the plotting arm, which places B^1 at the platen pivot and B^2 at the master key. The azimuth of the perpendicular to the base line is $107.00^\circ - 90.00^\circ = 17.00^\circ$. The procedure is as follows:

(a) Set and clamp the arms as follows:

1. The arm on the right to the azimuth of the perpendicular -30° .
2. The arm on the left to the azimuth of the perpendicular $+30^\circ$.

(b) Release the platen clamp and the slide holding the master key and slide the platen along the plotting arm until the index on the slide is set at the range equal to the length of the base line.

(c) Holding the platen slide at that range, swing the platen about its pivot and move the master key along the platen until the master key touches the relocating arm at the range equal to the length of the base line. Clamp the platen to the slide and the master key to the platen. The platen is now oriented.

(d) Slide the platen along the plotting arm until the slide touches its stop at the center of the circle; bring the base line stop against the edge of the platen and clamp the base line stop.

b. *Directing point.*—After the base line has been oriented, the position of the directing point must be located. The orientation of the directing point consists of placing it in its proper relation to the observation stations; that is, placing the gun push button on the platen in its proper relation to the platen pivot and the master key. If the azimuth and distance from the directing point to the station represented by the platen pivot are known, and if that azimuth can be set on the azimuth circle, the position of the gun push button may be found in the same manner as that of the master key in ordinary orientation. (See a(4) above.) When this method is used, the platen must be held in its orienting position against the slide stop and the base line stop. This method may be used regardless of the method used in orient-

ing the base line. An alternative method of orientation is the datum point method (see *a*(5) above) using the azimuth and range from the directing point to the datum point. When the gun plate is used and the location of all guns of the battery is desired, their positions on the gun plate may be located in the same manner as that described for the location of the gun push button.

c. Orientation for single-station position finding.—When the single-station method of position finding is used, put that station at the platen pivot and the DP at the gun push button and proceed as for orientation of a base line. (See *a* above.)

■ 78. OPERATION OF M1923 (CLOKE) BOARD.—Since on this board the rate of angular travel is determined by azimuths as on the 110° board, the operation of the board is the same for case II and for case III pointing. It is similar to that described for the 110° board (see par. 73) except in the operation of tracking. The azimuth and range to the set-forward point are measured by means of the relocating arm. For prediction by set-forward scales, the variations in procedure are the same as for the 110° plotting board (par. 73).

a. Horizontal base tracking.—Each arm setter sets his station arm to the azimuth received from the reader and calls, "Set." While the plotting arm is being set, the platen operator keeps the platen at the orienting position against the slide stop and the base line stop with the platen clamp loosened. When both arm setters have called, "Set," the platen operator tightens the platen clamp and slides the platen along the plotting arm until the master key touches the relocating arm. He may start this operation as soon as the plotting arm is set, but he may not complete it until the relocating arm is set. The plotter marks the position of the plotted point on the board by pressing the gun push button and calls, "Clear." The platen operator releases the platen clamp and withdraws the platen to the orienting position. This procedure is repeated for each plotted point. After three plotted points have been established, the location of the set-forward point is determined by one of the methods explained in chapter 9. The targ is placed on the set-forward point and the relocating arm is brought up in

contact with it so that the range and azimuth to the set-forward point may be read directly.

b. Vertical and self-contained bases.—A change from a horizontal base line to a vertical or self-contained base line makes a change in tracking only. All other operations and their sequence are unchanged. The number of men may be reduced by one since only one arm setter is necessary. The variations in procedure are as follows: The arm setter sets the plotting arm to the azimuth received from the reader, calls, "Set," and repeats the range to the platen operator. The platen operator slides the oriented platen out until that range is indicated on the plotting arm by the index on the platen slide and calls, "Set." The plotter then marks the position of the plotted point as before. (See also *a* above.)

c. For two-station operation, the following men are needed on the Cloke board:

- (1) Plotter.
- (2) Assistant plotter (platen operator).
- (3) Two arm setters.
- (4) Set-forward rule operator (when set-forward rule is used). This man is not needed when set-forward scales are used.

■ 79. THE PLOTTING AND RELOCATING BOARD M1 (fig. 67).—*a. General.*—This board is similar in construction and operation to the M1923 board. The principal differences are in the construction of the azimuth scale and the base line stop. The azimuth scale is in degrees only, and the readings are marked on an endless chain which can be adjusted by turning a handwheel to put any desired azimuth reading, from 0° to 360° , at the center of the arc; the arc subtended by the azimuth circle is about 120° . The base line stop has been redesigned to facilitate orientation. There are four sets of scales for the plotting and relocating arms as follows:

Scale (yards per inch):	<i>Maximum range (yards)</i>
200 -----	12,800
400 -----	25,600
800 -----	51,200
1,000 -----	64,000

b. Quick reorientation.—Because of the limited field of fire that is covered by the M1 board, a quick method of shifting the field of fire on the board has been devised. When the azimuth of the target from a base-end station or from the directing point approaches the outer limits of the azimuth scale, shift the field of fire toward the center of the board by the following method:

(1) Unclamp the platen and bring it against its two stops in the orienting position.

(2) Set the plotting arm to any even graduation on the azimuth scale near the center of the board.

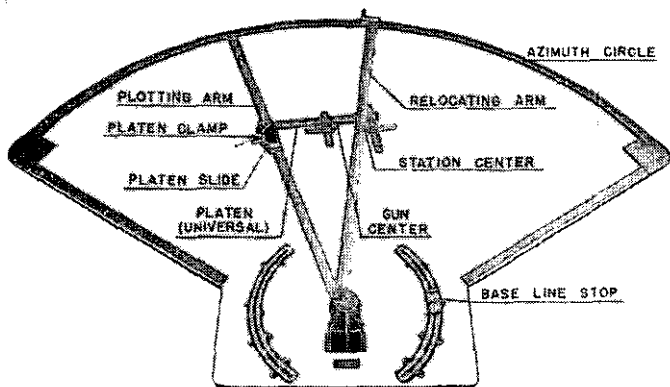

FIGURE 67.—Plotting and relocating board M1.

- (3) Clamp the platen to the plotting arm.
- (4) Unclamp the base line stop and move it out of the way.
- (5) By means of the handwheel, rotate the azimuth scale chain the desired amount.
- (6) Move the plotting arm to the new position of the graduation at which it was previously set. In so doing, the platen, which is clamped to the plotting arm, is moved through the same angle and will be in orientation with respect to the new position of the azimuth circle chain.

(7) Bring the base line stop against the platen in the new position and clamp. Unclamp the platen.

(8) The board is now oriented and ready for operation. The amount of shift possible by this method is limited by the range of movement of the base line clamp.

c. The method described in *b* above can be used for the orientation of the base line if the azimuth of the base line were to fall off the azimuth scale when the center of the field of fire is placed near the center of the board. In this case, the chain can be positioned so that the azimuth of the base line can be set near one edge of the board. The relocating arm is now used to orient the base line by the ordinary method and the base line stop is brought up in contact with the platen and clamped. The plotting arm is then set to any convenient azimuth and the platen still in contact with base line stop is clamped to the plotting arm. The base line stop is moved out of the way, and the chain is rotated to bring the azimuth of the center of the field of fire near the center of the board. The plotting arm with the platen still clamped to it is now moved to the graduation at which it was previously set, the base line stop is again brought up and clamped in contact with the platen, and the platen is unclamped. The plotting board is now in orientation. Extreme care must be taken to see that there is no slippage between the plotting arm and the platen while the arm is being moved through the desired angle.

CHAPTER 11

RANGE CORRECTION DEVICES

	Paragraphs
SECTION I. General.....	80-81
II. Wind component indicator.....	82-84
III. Range correction board M1A1.....	85-88
IV. Other models of range correction boards.....	89-93
V. Percentage corrector M1.....	94-95

SECTION I

GENERAL

■ 80. FUNCTIONS.—*a.* The functions of range correction devices are to provide means for determining the range corrections due to nonstandard ballistic conditions, to apply those corrections to the range to the set-forward point, to apply range adjustment corrections as a result of observation of fire, and to transform the corrected range into suitable data for pointing the guns in elevation.

b. The necessity for ballistic corrections was discussed in paragraph 22. The corrections are determined by a range correction board supplemented by the wind component indicator. Data from the firing tables relative to the gun, projectile, powder, and fuze combination used are presented in graphical form on a chart attached to the range correction board. Given the prevailing nonstandard conditions, the ballistic correction can be obtained from the chart mechanically. The board is so constructed that changing conditions may readily be introduced and the correction rapidly determined.

c. The percentage corrector applies the ballistic and fire adjustment corrections to the map range to the set-forward point. The adjustment corrections are determined after observation of fire and after operation of the devices comprising the spotting system of the battery. The necessity for these corrections is discussed and the spotting devices are explained in chapter 14. All range corrections are applied as a percentage of the range. The corrected range, where

necessary, is converted into data suitable for use in pointing the guns in elevation. The converted data are supplied to the guns in either of two forms: elevation in mils or degrees, or elevation in terms of range in yards. If the device used for pointing the gun in elevation is a range drum marked in range in yards, data are supplied in that manner.

■ 81. METEOROLOGICAL MESSAGE.—*a. Description.*—(1) Information as to variations from standard atmospheric conditions are contained in the meteorological message. Data contained in this message are determined by the personnel of the meteorological station and supplied to the using battery hourly during any period when firing is expected. The meteorological message consists of groups of symbols arranged in codified form. The message starts with the code designation of the sending station. This code designation, consisting of three letters, the first of which is always the letter *M* and the other two the identifying letters of the station, is repeated. This is followed by several number groups. The first number group has five digits and the remaining groups have seven digits each. The five-digit group has the following significance: the first digit is either the figure 2 or the figure 3 and denotes the type of the message. The figure 2 denotes that the message is to be used for high-angle (antiaircraft) fire; the figure 3 that it is to be used for low-angle (seacoast) fire. The second and third digits of the group give, in hundreds of feet, the altitude of the meteorological datum plane (m. d. p.) above sea level. The fourth and fifth digits give the temperature at the m. d. p. in degrees Fahrenheit. All the seven-digit groups are similar to each other in type and significance. Each seven-digit group represents a weighted average of the ballistic conditions that exists between the m. d. p. and a limiting altitude indicated by the first figure of the group. This limiting altitude is known as the standard altitude for the group. The first digit (the altitude number) of each group designates that standard altitude. The second and third digits indicate the direction from which the ballistic wind is blowing in hundreds of mils clockwise from north. The fourth and fifth digits give the speed of the ballistic wind in miles per hour. The last two digits give the ballistic density in percent of normal.

(2) The following is a typical meteorological message:

MFMMFM

30278
 0241699
 1231799
 2221899
 3211800
 4211900
 5202001
 6202001
 7192102
 8192102
 9192102
 0182103
 1182203

(3) The message may be translated as follows:

Meteorological message from station FM for low-angle fire.

Altitude of m. d. p.—200 feet above sea level.

Temperature at m. d. p.—78° F.

Altitude number	Standard altitudes (feet) (upper limit)	Direction from which ballistic wind is blowing in mils clockwise from north	Speed of ballistic wind in mph	Density percent of normal
0 (surface)	0	2, 400	16	99
1.....	600	2, 300	17	99
2.....	1, 500	2, 200	18	99
3.....	3, 000	2, 100	18	100
4.....	4, 500	2, 100	19	100
5.....	6, 000	2, 000	20	101
6.....	9, 000	2, 000	20	101
7.....	12, 000	1, 900	21	102
8.....	15, 000	1, 900	21	102
9.....	18, 000	1, 900	21	102
10.....	24, 000	1, 800	21	103
11.....	30, 000	1, 800	22	103

b. Application.—(1) The data taken from a meteorological message for a selected firing will be that contained in the five-digit group and one of the seven-digit groups. The seven-digit groups contain data as to the ballistic wind and the ballistic density. The ballistic wind is a fictitious wind, constant in magnitude and direction, which would have the same total effect on the projectile during its flight as the true winds of varying magnitude and direction that are actually encountered. It is computed from observations taken on the true winds at different altitudes above the m. d. p. Likewise, the ballistic density is a fictitious constant density which would have the same total effect as the various true densities and is computed from observations and formulas. Each seven-digit group contains the data for the ballistic wind and ballistic density for one standard altitude only. The values given indicate the ballistic conditions between the m. d. p. and the standard altitude. The particular seven-digit group appropriate for use is that group of which the altitude above the m. d. p. is nearest to and not less than the maximum ordinate of the trajectory for the range to the target as measured from the battery level. When the battery and the m. d. p. are not at the same altitude above sea level, the temperature and the ballistic density must be corrected for the difference in altitude.

NOTE.—The m. d. p. should be within 500 feet above or below the battery.

The data concerning the ballistic wind are taken without change. Formulas for the correction of temperature and ballistic density may be found in all firing tables. The data from the meteorological message are used, part on the wind component indicator and part on the range correction board as will be discussed later.

(2) The following example shows the application of a meteorological message to a selected firing:

Example.—A battery of 12-inch guns M1895 on barbette carriage M1917, using 975-pound projectile (Firing Tables 12-F-3), is firing at a target at a range of 18,400 yards. The altitude of the battery is 20 feet above sea level. What data from the meteorological message given in *a* above should be used? What are the corrected data?

Solution: From part 2, table A, Firing Tables 12-F-3, the maximum ordinate for a range of 18,400 yards is found to be 4,405 feet. The correct zone for any particular range may be determined from the left-hand column on the right of the range correction chart. Therefore, data for the fourth altitude number (upper limit 4,500 feet) should be used. The complete data from the message are—

Altitude m. d. p.—200 feet.

Temperature at m. d. p.—78° F.

Ballistic wind—2,100 mils from north at 19 mph.

Ballistic density—100 percent.

Since the battery and m. d. p. are not at the same altitude, corrections must be made to the temperature and density. It will be noted that in determining these corrections, the difference in altitude is taken to the nearest 100 feet. The corrections for temperature and density are computed according to the following formulas:

Temperature—an increase of $\frac{1}{5}^{\circ}$ F. for each 100-foot decrease in altitude from the m. d. p.

Density—an increase of 0.3 percent for each 100-foot decrease in altitude from the m. d. p.

The corrections for temperature and density for the above example are as follows:

Altitude of m. d. p.----- 200 feet.

Altitude of battery----- 20 feet.

Difference in altitude (battery below m. d. p.)

180 feet or 200 feet to nearest 100 feet.

Temperature:

Correction:

$1/5 \times 2 + 78 = 78.4^{\circ}$ F., or 78° F., to the nearest degree.

Density:

Correction:

$0.3 \times 2 + 100 = 100.6$ or 101 percent to the nearest percent.

The complete corrected data are—

Temperature—78° (nearest degree).

Ballistic wind—2,100 mils from north at 19 mph.

Ballistic density—101 percent (nearest percent).

SECTION II

WIND COMPONENT INDICATOR

■ 82. WIND CORRECTION PROBLEM.—The ballistic wind can be considered as having two effects on a projectile during its time of flight: one in direction perpendicular to the plane of fire, and one in range parallel to the plane of fire. In making corrections for the effect of the wind, the ballistic wind is resolved into two components. One is called the deflection component or that portion affecting the direction, and one is called the range component or that portion affecting the range. For example, determine the range and deflection components of the wind under the following conditions:

Azimuth of wind.....	2,100 mils (N).
Azimuth of target.....	90° (S).
Speed of the wind.....	19 mph.

The sketch at the top of figure 68 illustrates the problem. Let *G* represent the guns, *GT* the direction of the target or plane of fire, and *WG* the azimuth from which the wind is blowing. The range component parallel to or along the plane of fire is represented by *GT*=17 mph, and is a tail wind since it is aiding the projectile in flight. The deflection component perpendicular to the plane of fire is represented by *TW*=9 mph, and is blowing the projectile to the right. This same problem can be solved mechanically by the wind component indicator. For the mathematical solution refer to any set of firing tables.

■ 83. DESCRIPTION.—The wind component indicator (fig. 68) is a device for mechanically resolving the ballistic wind into its range and deflection components. It consists of a circular plate (*P*), called the grid, surrounded by an azimuth circle; and an arm (*A*), called the target arm, pivoted at the center and riding above both. The plate is stationary; it is engraved with cross-section lines spaced in units of miles per hour but marked in wind reference numbers with 50 as the normal. (See par. 61.) The index (*K*) at the bottom is called the wind azimuth index, opposite which the azimuth of the wind is normally set. The azimuth circle is movable and

is engraved with two azimuth scales, an inner scale in mils and an outer scale in degrees. The zeroes of the two scales are 180° apart. This arrangement was chosen to permit the use of wind azimuths in mils from north and target azimuth in degrees from south. The target arm is engraved with a linear scale graduated in miles per hour to the same scale as that used on the grid. By means of this scale the setting end (H) of the pointer carried by the arm may be set so that its reading end (H') is at a distance from the center of the circle equal to the speed of the ballistic wind. A single instrument serves for both range and deflection computations. The range component may be read from the vertical scale and the deflection component from the horizontal scale on the plate.

■ 84. ORIENTATION AND OPERATION.—*a.* Orientation of the wind component indicator depends upon the reference line from which the azimuth of the target is measured and the angular units in which the azimuth is measured. This dictates the position at which the wind azimuth is set, either at the top of the center line of the grid or at the wind azimuth index at the bottom. The following rules will be followed in operating the instrument. If the target azimuth is measured:

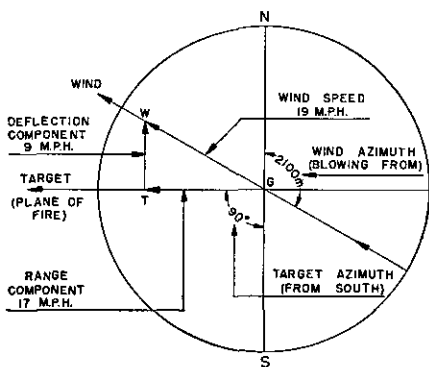

①

FIGURE 68.—Wind component indicator.

- In degrees from south—set wind azimuth at bottom.
 In mils from north—set wind azimuth at bottom.
 In degrees from north—set wind azimuth at top.
 In mils from south—set wind azimuth at top.

b. Having determined the proper position for setting the wind azimuth, the operator chooses the correct line of the meteorological message and sets the azimuth of the wind on the mil scale opposite the appropriate index of the grid (top or bottom). The wind speed from the meteorological

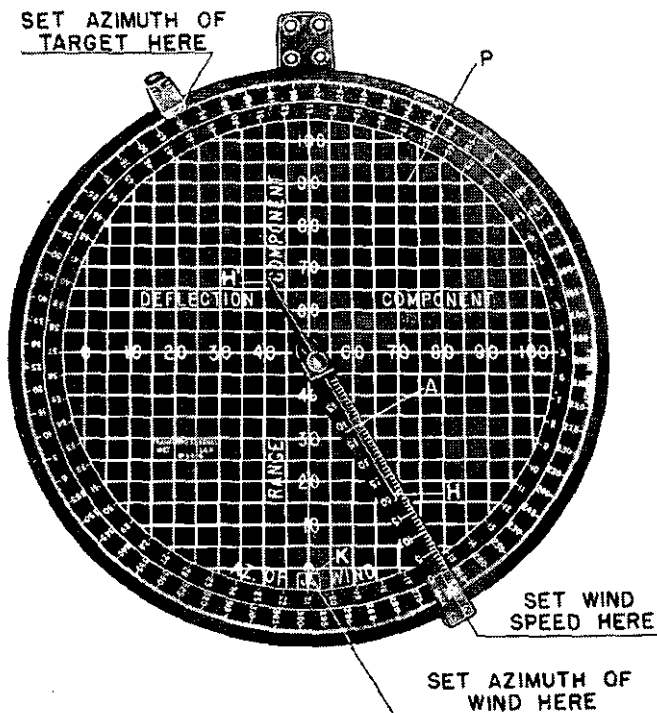

②

FIGURE 68—Continued.

message is then set on the target arm. The target azimuth index is positioned opposite a reading on the azimuth circle corresponding to the azimuth of the set-forward point. The range wind component in reference numbers is then read opposite the pointer (H') on the vertical scale and transmitted to the range correction board. The deflection component in reference numbers is read opposite pointer (H') on the horizontal scale and transmitted to the deflection board. Each time there is a change in the component reference number of one unit, the new reading is transmitted to the proper board. The target azimuth index is kept on the latest set-forward point azimuth as received from the plotting board.

c. The example problem in paragraph 82 is shown set up on the wind component indicator in figure 68. Note the wind components in reference numbers. The range wind component is 67 and from the analysis in paragraph 82, we know it is tail wind. The value of the component in mph may be found by subtracting the normal from the component reference number so: $67-50=17$ mph. Since the result is plus (+), the wind is a tail wind. Range wind reference numbers below 50 must therefore indicate a head wind. The deflection component is 41 and also from paragraph 82, we know it is a wind blowing the projectile to the right. The amount of the component in mph is found as above— $41-50=-9$ mph to the right. Therefore, deflection wind reference numbers less than 50 indicate a wind blowing the projectile to the right.

d. In regard to wind component reference numbers, we may state the following rules:

(1) Range reference numbers.

(a) Greater than 50 indicate a tail wind.

(b) Less than 50 indicate a head wind.

(2) Deflection reference numbers.

(a) Greater than 50 indicate a wind blowing the projectile to the left.

(b) Less than 50 indicate a wind blowing the projectile to the right.

SECTION III

RANGE CORRECTION BOARD MIA1

■ 85. DESCRIPTION.—*a.* A range correction board (fig. 69) is a mechanical device for determining the algebraic sum of the range corrections due to prevailing nonstandard ballistic conditions. This correction is called the ballistic correction. The MIA1 board is typical and, since it is the present standard range correction board, will be explained in detail.

b. The board consists of three major parts: a chart, a ruler, and a mount. There are rollers contained in the mount to which the chart is attached.

(1) The chart has a set of curves for each nonstandard condition for which a correction is made. There are seven ballistic conditions for which corrections may be made: muzzle velocity, atmospheric density, height of site (or tide), ballistic wind, weight of projectile, elasticity (or temperature of the air), and rotation of the earth. Each set consists of a series of curves, one curve for the standard condition (the normal of the set), and one for each unit of variation from standard that it is desired to show. The curves are plotted by rectangular coordinates with range as ordinates and range effects in percent of the range as abscissae. The range and other pertinent firing table data are listed along the sides of the chart. The data for plotting are taken from the firing tables. A chart must be constructed for each combination of gun, powder charge, and projectile. Occasionally a difference in fuze must also be considered in selecting the charts to be used. Further details on the construction of the chart may be found in appendix VI.

NOTE.—The effect of rotation of the earth, on both range and direction, varies with the latitude of the firing position, the azimuth of the plane of fire, and the elevation (or range). Since only two variables may be shown on one set of curves and it was considered impracticable to furnish sufficient curves for all situations in a readily usable form, one of those variables had to be eliminated. The variable causing the least change in the effect is the latitude. It was therefore decided to construct the curves for a mean latitude of 30° for use within the United States. Each curve is plotted for a selected azimuth of the target. These curves are normally plotted for batteries oriented from south.

(2) The ruler consists of a strip of metal with two raised bars extending across it. The upper bar is fixed to the ruler; the lower bar is movable and may be slid across the ruler in either direction. A system of gears actuated by a knob is provided for sliding the movable (locking) bar. Mounted on the two bars are seven pointers, one for each set of curves on the chart. Each pointer has a double-action clamp by which it may be clamped to either of the two bars. Normally, all clamps remain in the position *S* (under spring pressure), the movable bar is up, and the range correction knob is locked. When one clamp is turned to *M* the movable bar is moved down, causing all other pointers to be locked in their original *S* positions and releasing the range correction knob. The movable bar may be pulled down to release the range correction knob for making the initial normal setting. The range correction scale is located just below the reading index on the frame of the ruler. The scale is graduated in reference numbers using a normal of 300 with a least reading of 1. These reference numbers indicate corrections in percent of range. Ten units in reference numbers indicate 1 percent in range (see ch. 8). The reading index is attached to the movable bar to record mechanically the movement of each pointer. When a pointer is moved from its normal curve to the intersection of the proper range line and the curve representing the nonstandard condition that prevails, the index on the movable bar is displaced in the same direction and by the same amount. By setting each pointer in turn, the algebraic sum of the corrections is indicated on the range correction scale. (See figs. 70 and 71.) Just below the range correction scale is an adjustment correction scale. This may be used for flat percentage corrections to the range. Unless otherwise specified by the battery commander, the reading opposite the fixed index below the adjustment correction scale should be 300. It is important that this setting be checked frequently since there is always the possibility of accidental displacement.

(3) The mount is a metal case that contains the charts and rollers. The ruler is fixed to the top of the case by clamps allowing a slight movement of the ruler for adjustment.

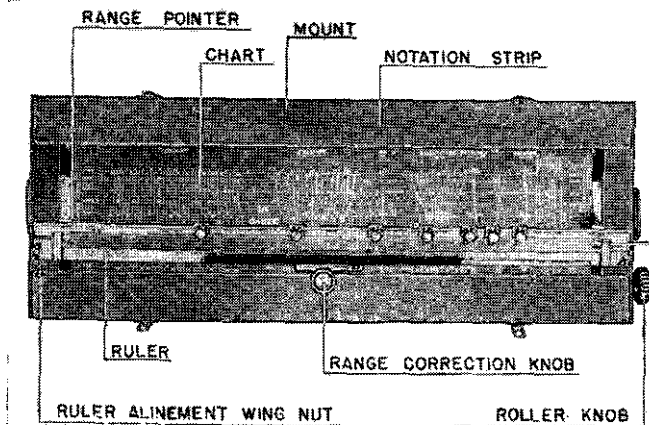

FIGURE 69.—Range correction board M1A1.

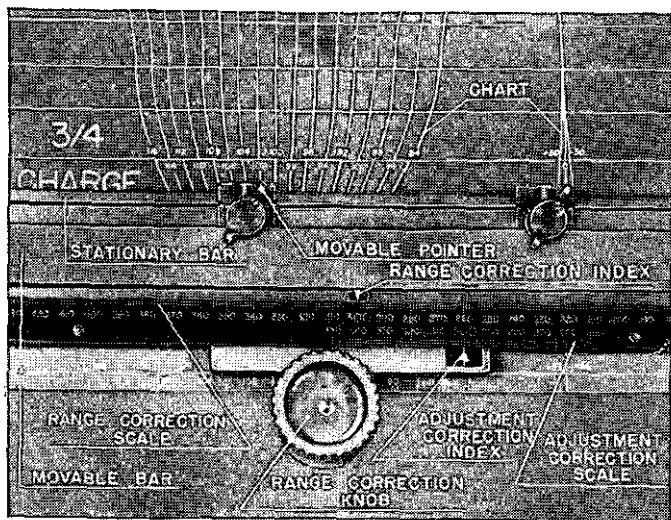

FIGURE 70.—Range correction board M1A1, operating mechanism—range correction scale set to normal.

c. The board is designed for continuous operation throughout the firing. As the range to the set-forward point changes, the chart is moved to keep the proper range line under the ruler. Each pointer may then be moved in turn to bring it to the intersection of the curve with the new range line. This operation changes the correction by the amount of change due to the change in range and has the same effect as though the pointers were all brought back to

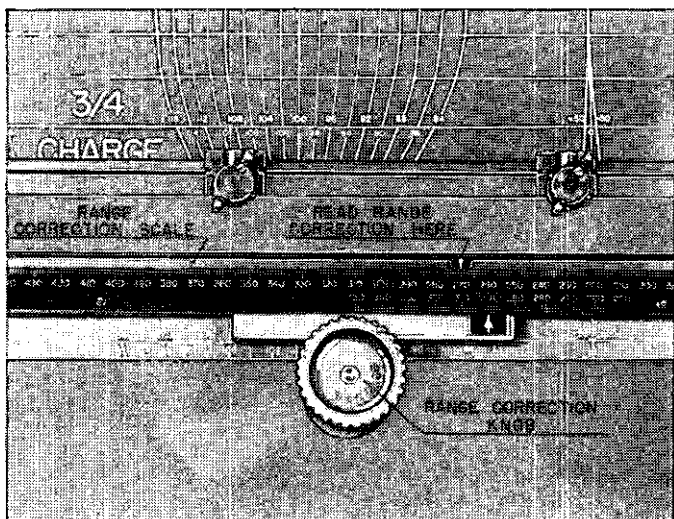

FIGURE 71.—Range correction board M1A1—range correction scale set at 270.

normal and reset at the proper curves. Changes in any nonstandard condition, such as a change in the wind reference number due to a change in the azimuth of the target, may be made in the same way.

■ 86. ADJUSTMENT.—*a.* The mechanical adjustments of the board are the adjustment of the chart and the adjustment of the correction ruler. The chart must be adjusted on its rollers so that the normal lines on each set of curves will not be displaced laterally as the chart is moved past the

ruler. The ruler must be placed parallel to the horizontal range lines on the chart and clamped in that position. These adjustments may be tested as follows: Set the pointers at their normal correction curves and move the chart back and forth on the rollers. The normal curves, which are straight lines, should remain under the indexes of the pointers for all positions of the chart.

b. A further adjustment must be made prior to the operation of the board. The range correction scale is free to be moved back and forth on the frame of the ruler. It is positioned so that 300 on the adjustment correction scale is opposite the fixed index at the bottom. The pointers are placed on the normals of the curves. This should give a correction in reference numbers of 300 opposite the range correction index (see fig. 70). If the range correction index is not at 300, the movable bar is pulled down, disengaging all the pointers from the movable bar, and the operating knob is turned until the range correction index is positioned at a normal reading of 300. (See fig. 70.) All pointer clamps should be turned to *S* position.

■ 87. OPERATION.—*a.* The operator of the board turns the roller handle until the appropriate chart for the firing appears under the correction ruler. He adjusts the ruler and tests the adjustment of the chart, making any changes found necessary. Based on the first range to the set-forward point called out by the plotter, he ascertains the proper line of the meteorological message to use and records the information contained in it with chalk on the notation strip at the top of the board. He obtains these data as follows:

(1) Muzzle velocity, in feet per second, from the range officer.

(2) Atmospheric density, in percent of normal density, from the meteorological message (corrected for difference in elevation).

(3) Height of site or tide, in feet, from the range officer or from the tide message.

(4) Ballistic wind, in wind reference numbers, from the wind component indicator.

(5) Weight of projectile, in pounds, from the range officer (who gets the average weight from the battery executive).

(6) Elasticity, in degrees Fahrenheit, from the meteorological message (corrected for difference in elevation) or from a thermometer at the battery.

(7) Rotation of the earth, in degrees, from the plotter. (This setting is the azimuth to the set-forward point.)

NOTE.—If, after firing has started, the operator encounters a new meteorological line caused by an increased or decreased range, he continues to use the data given in the old line. The reason for this is that errors in going from one line to another are being corrected by adjustment through the operation of the fire adjustment board.

b. To apply the preceding data to the board the operator moves the chart to bring the proper range line under the ruler and sets each pointer in turn to the proper curve. A pointer is set by—

(1) Turning the clamp to the position *M*.

(2) Operating the correction knob on the ruler until the pointer is opposite the proper correction curve.

(3) Turning the clamp back to *S*.

After all the pointers are set, he calls out to the operator of the percentage corrector the ballistic correction indicated on the range correction scale. Thereafter he keeps the chart set at the proper range line and each pointer set at its proper curve. He notes any change of the wind reference number on the wind component indicator and of the azimuth of the set-forward point; changes the record at the top of the board to indicate the new wind and rotation curves; and adjusts the setting of the pointers to these curves. He announces a new ballistic correction whenever it changes by one unit ($\frac{1}{10}$ of 1 percent of the range).

■ 88. **ACCURACY TESTS.**—The accuracy of the board may be checked by data taken from the firing tables. For example, assume that the chart for 16-inch guns, Mk. II (Navy) firing 2,240-pound AP projectile, fuze with BD fuze, Mk. X, full charge, normal muzzle velocity of 2,650 f/s (Firing Tables 16-E-1), is to be checked for a target at a range of 24,000 yards and at an azimuth 333° from south. The firing position is at 40° north latitude. The prevailing nonstandard conditions and the proper range corrections as taken from Firing Tables 16-E-1 are as follows:

Nonstandard conditions	Corrections	
	Yards	Percent
Muzzle velocity, -30 f/s.....	+471	+1.96
Air density, 97 percent.....	-205	-0.85
Height of tide, 10 feet ¹	+10	+0.04
Wind reference number, 70.....	-94	-0.39
Weight of projectile, 2,240 pounds ²		
Temperature (elasticity) of air, 50° F.....	-50	-0.21
Rotation of the earth.....	-60	-0.25
Net correction.....	+72	+0.30

¹ Correction for height of tide is obtained from TARGET ABOVE GUN table for positive tide, and TARGET BELOW GUN table for negative tide. The height of site correction is taken care of in the graduation of the range elevation tape for the percentage corrector.

²The variation in weight of these projectiles is so small the effect is negligible.

The algebraic sum of the range corrections is 0.30 percent. The range correction in reference numbers that the board should indicate for the same nonstandard conditions is $300 + 3 = 303$.

SECTION IV

OTHER MODELS OF RANGE CORRECTION BOARDS

■ 89. GENERAL.—There are four other models of range correction boards that have been issued in the past and which may be found in service. In design and operation they are all similar to the range correction board M1A1 with a few minor exceptions as noted in paragraphs 90 to 92, inclusive.

■ 90. PRATT RANGE CORRECTION BOARD M1905 (MODIFIED).—On the Pratt board the chart is fixed and the correction ruler is moved along the chart as the range changes. Markers are provided near the top of the board for use in indicating the proper curves to use in determining corrections. The board has been modified to indicate range corrections in percent of the range, but the movement of the index that registers on the correction scale is one-half that of the pointers. Therefore the correction scale should be graduated to twice the scale of the chart.

■ 91. RANGE CORRECTION BOARD M1923.—This board is a development of the Pratt board. It is the first model of range correction board on which the chart is carried on rollers. On some boards the gearing has been modified so that the movement of the index is equal to that of the pointers; on others this modification has not been made. Whether or not the modification has been made will be disclosed by an inspection of the board.

■ 92. MODIFIED RANGE CORRECTION BOARD M1923.—This board is the predecessor of and is very similar to the M1 board.

■ 93. RANGE CORRECTION BOARD M1.—This board is identical to the M1A1 board except that it is possible to move more than one pointer at a time if care is not taken. The self-locking feature was added to this board to produce the M1A1. The M1 boards are being modified as rapidly as circumstances permit.

SECTION V

PERCENTAGE CORRECTOR M1

■ 94. DESCRIPTION.—*a.* The percentage corrector M1 (fig. 72) is a mechanical instrument used to apply ballistic and adjustment corrections to the uncorrected range to the set-forward point and transform the resulting corrected range into data suitable for pointing the guns in elevation. Corrections, both ballistic and adjustment, are applied to the uncorrected range as a percentage of that range. To avoid confusion, corrections are given in reference numbers. This method of application is most easily accomplished by multiplying the uncorrected range by a correction factor which is equal to 100 percent plus or minus the percentage correction. The operation may be performed mechanically provided the scales of adjustment corrections, ballistic corrections, and ranges are each graduated logarithmically to the same scale. The percentage corrector M1 is so constructed.

b. The instrument may be divided into four parts.

(1) The container, a rectangular box with an open top covered with xylonite.

(2) Two correction scales, one for ballistic corrections and one for adjustment corrections.

(3) A range tape mounted on rollers at the ends of the box and passing over the top under the xylonite cover.

(4) An interpolator mounted on the side of the box. (Refer to fig. 73.)

c. The xylonite window on top of the box has an index engraved on it at the center. The uncorrected range to the set-forward point is always set under this index. The location of this index line should be frequently inspected to insure that it is directly opposite the graduation marked 300 on the ballistic correction scale.

d. The ballistic correction scale is fixed to the box and is shown directly below the xylonite window in figures 72 and 74. It is graduated logarithmically in percentages and marked in reference numbers with 300 as normal, representing a factor of 100 percent. These reference numbers correspond to the system used on the range correction board. An index for the ballistic correction scale, called the "ballistic pointer," is fixed to a slide in the top of the box. The adjustment correction scale is carried on this slide and fixed to it. It is also graduated logarithmically and marked in reference numbers with 300 as normal. The ballistic pointer is attached to the adjustment scale so that its reading edge is in line with 300 on the adjustment scale. Any movement of the ballistic pointer then displaces the adjustment scale the same amount. The adjustment pointer or "read pointer" is carried on a slide within the first slide. Adjustment corrections are set by positioning the read pointer opposite the given adjustment correction on the adjustment scale. Corrected ranges are always read opposite this pointer. If there is no adjustment correction, the read pointer will appear directly over the ballistic pointer. The range tape carries a range scale (logarithmically graduated) on the side next to the ballistic correction scale. In addition to the range scale, other scales are provided to convert the ranges into data suitable for use in pointing the gun at the proper elevation to obtain the desired range. All scales being logarithmic, the corrector acts as a logarithmic slide rule. Setting the ballistic pointer on the ballistic correction scale multiplies the range set at the normal of that scale by a factor (ballistic correction factor) which is equal to 100 percent plus or minus the ballistic

correction in percent. Setting the read pointer on the adjustment scale multiplies the ballistically corrected range by another factor (adjustment correction factor) which is equal to 100 percent plus or minus the adjustment correction in percent. This is equivalent to multiplying the uncorrected range by the product of the ballistic and adjustment correction factors.

Example:

Given an uncorrected range of 12,000 yards, a ballistic correction in reference numbers of 365 (up 6.5 percent from normal, or 106.5 percent of the uncorrected range) and a fire adjustment correction in reference numbers of 275 (down 2.5 percent of normal or 97.5 percent of the ballistically corrected range).

Problem: Determine the corrected range in yards.

Application of ballistic correction

$12,000 \times 1.065 = 12,780$ yards (ballistically corrected range)

Application of fire adjustment correction

$12,780 \times 0.975 = 12,460$ yards

Corrected range = 12,460 yards.

If the gun is set in elevation by means of a range disk, graduated for the ammunition being used, the one range scale is sufficient. If the range disk is graduated for ammunition other than that being used, a range-range relation tape is necessary to obtain the proper range disk setting corresponding to the desired range. (See app. VI for a more detailed discussion.) If the gun is pointed in elevation by setting in angular units, it is necessary to have a scale on the tape showing the range-elevation relation for the particular type of ammunition being used. Hence, the range tape is so constructed that opposite the graduation for any range can be found the proper range disk or elevation setting to obtain that range. The percentage corrector has on one side an auxiliary device known as an "interpolator" which is designed for use when employing a firing interval less than the interval between predictions on the plotting board. The interpolator consists of a wooden frame with two rollers in which is wound a range tape or an elevation tape. An interpolating plate rides in guides on top of the interpolator and

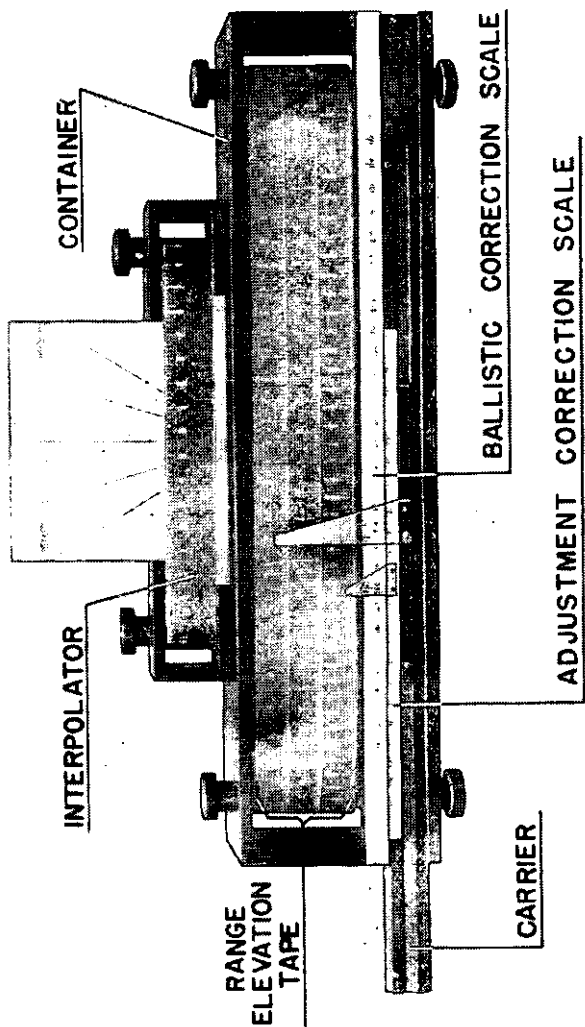

FIGURE 72.—Percentage corrector MI.

is engraved with lines and figures as shown in figure 73. The plate may be moved freely in and out and the tape is moved over it. A small rider may be improvised for use on the tape if desired. Upon request, scales for the percentage corrector will be furnished by the Coast Artillery Board, Fort Monroe, Virginia. (See app. VII for instructions.)

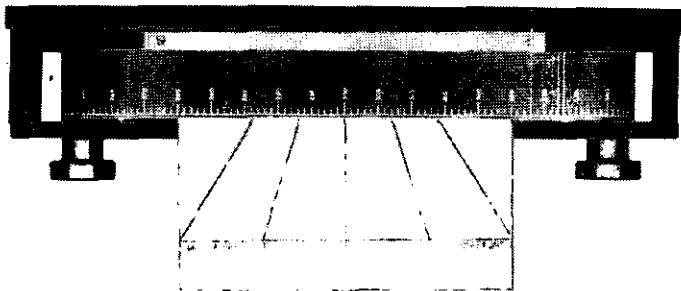

FIGURE 73.—Interpolator on percentage corrector M1.

■ 95. OPERATION.—*a.* When the interpolator is not used, one operator is required. He wears a telephone head set connecting him to the range or elevation setters at the guns. As soon as the uncorrected range to the set-forward point is called out from the plotting board, he sets that range on the basic logarithmic range scale (see par. 94*d*) at the index line on the xylonite. He keeps the ballistic pointer set on the ballistic correction scale at the ballistic correction called out by the operator of the range correction board. If an adjustment correction has been ordered, he sets the read pointer at that correction on the adjustment correction scale; otherwise the read pointer coincides with the ballistic pointer. He then telephones to the range or elevation setters at the guns the corrected range or elevation indicated by the read pointer on the range or elevation scale corresponding to the particular combination of powder charge and projectile being used. He continues to make the proper settings of uncorrected ranges and corrections and to transmit the corrected firing data to the guns at the proper intervals.

The new data should not be transmitted to the guns until after the sounding of the firing bell for which the previous data were figured. Whenever the operator receives a new adjustment correction, he incorporates it into the next data and, when those data are sent, calls out, "Correction applied."

b. When the interpolator is used, two operators are required. The duties of the percentage corrector operator consist simply of setting the uncorrected ranges and the ballistic and read pointers. An additional operator operates the interpolator, wears the telephone head set, and transmits the corrected ranges or elevations to the guns. For the purpose of this explanation it will be assumed that predictions are to be made every 20 seconds, that elevations are to be sent to the guns every 10 seconds, and that the time interval system is arranged to give three strokes of the bell every 20 seconds (known as the "3 bell") and one stroke at each intermediate interval of 10 seconds (known as the "1 bell"). The operation of the interpolator is then as follows:

(1) On the 1 bell, or as soon thereafter as practicable, the interpolator operator transmits to the guns the elevation (or corrected range) indicated by the read pointer. (This elevation is for firing on the next 3 bell.) He moves the tape so that this elevation is exactly over the center line of the interpolating plate and fastens the rider on the tape at this point.

(2) Immediately after the next 1 bell, he transmits to the guns the elevation indicated by the read pointer and moves the interpolating tape so that the new elevation is exactly over the center line on the interpolating tape. This operation displacing the rider, he moves the interpolating plate in or out until one of the outer lines on the plate marked 1 intersects the tape at the index of the rider. The rider is then moved back to position above the center line of the plate. If the range is increasing, the elevation to be sent to the guns after the next 3 bell is indicated where the tape is intersected by the 3 line on the side of the plate marked INCREASING. For decreasing ranges the readings are on the other side of the center line. In figure 73 the elevation for the first 1 bell was 286 mils; for the second 1 bell, 300 mils. The elevation to be sent to the guns after the next 3 bell is

indicated by the intersection of the 3 line with the tape on the increasing side of the plate, or 307 mils.

(3) The operations just described are repeated at the proper times, directly computed elevations (good for firing on the 3 bell) being sent to the guns immediately after each 1 bell and interpolated elevations (good for firing on the 1 bell) immediately after each 3 bell. In case a prediction is missed

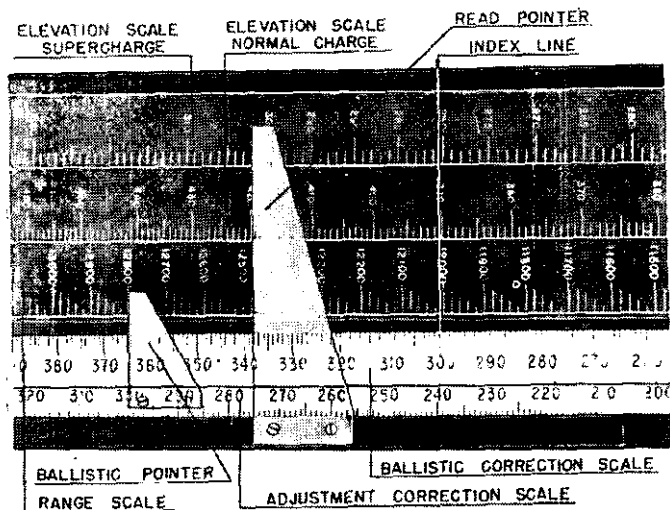

FIGURE 74.—Ballistic and correction pointer settings on percentage corrector M1.

for any reason, an approximate elevation for firing on the next 3 bell is always indicated by the intersection of the outer 1 line on the proper side of the plate.

(4) If it is desired to furnish data at intervals that are smaller subdivisions of the interval between predictions, appropriately spaced lines may be marked on the reverse side of the interpolating plate and interpolations made in a manner similar to that described in (2) above.

CHAPTER 12

DIRECTION CORRECTION DEVICES

	Paragraphs
SECTION I. General.....	96
II. Universal deflection board.....	97-100
III. Angular travel computer.....	101-102
IV. Deflection board M1.....	103-109

SECTION I

GENERAL

■ 96. FUNCTIONS.—*a.* The functions of direction correction devices depend on the method of pointing used. In case II, the functions are to determine and add algebraically the lateral corrections for wind, drift, angular travel of the target during the time of flight, and fire adjustment and to indicate the corrected deflection for use on the gun sights. In case III pointing, they are to determine and add to the uncorrected azimuth of the set-forward point the corrections for wind, drift, rotation of the earth, gun displacement, and fire adjustment. Correction for rotation of the earth normally need not be made in case II because the correction is negligible for the short ranges at which guns fire with case II pointing. Corrections in direction for gun difference need not be made in case II, because in normal battery emplacements, the guns are close enough so that the angular travel of the target is the same at all guns. In case III the correction for travel of the target is made in determining the set-forward point.

b. On all lateral pointing instruments designed for seacoast artillery, an increased azimuth or deflection setting will cause the gun to shoot to the right. On computing devices, azimuths, and deflections increase to the right on straight scales and clockwise on circular scales, and the instruments are so made that corrections to the right will increase and corrections to the left will decrease the azimuth or deflection. To shoot to the right, increase the azimuth or deflection

reading; to shoot to the left, decrease the azimuth or deflection reading. The coast artilleryman's slogan is "Right, raise—left, lower."

SECTION II

UNIVERSAL DEFLECTION BOARD

■ 97. DESCRIPTION.—*a. General.*—(1) The universal deflection board (fig. 75) may be used with either case II or case III pointing for any type of gun. For case III pointing it provides means of applying to the uncorrected azimuth of the set-forward point the lateral corrections for wind, drift, rotation, and fire adjustment. Since it cannot take care of the lateral correction for gun displacement, an azimuth difference chart must be made if such corrections are needed. In case II, the corrections for wind, drift, angular travel, fire adjustment, and (rarely) rotation are added to give a corrected deflection for the gun sights. Since the board provides no means for actually computing the correction for angular travel, the computation must be made on another instrument, the angular travel computer. (See pars. 101 and 102.)

(2) This board was designed to replace earlier instruments, but before it was standardized for issue, the M1 board (see sec. IV) was developed and made standard. The universal board can be made easily and cheaply, and its use is recommended to those batteries not equipped with the M1 board. It should be retained for alternate use by batteries that are equipped with the M1 board. Construction plans, azimuth and deflection tapes, and correction charts can be obtained from the Coast Artillery Board, Fort Monroe, Virginia. Organizations sending for these should include with their requests complete data concerning the guns, sights, and ammunition with which the board is to be used.

(3) The main mechanical parts of the instrument are the board, carrier, rider, pointer arm, and slide. There are two rollers at the lower corners for mounting the azimuth tape. A set of curves for wind and drift corrections is mounted on the face of the board with the zero deflection line parallel to the arm of the carrier. The carrier is mounted in a slot allowing lateral movement across the board. It carries on a

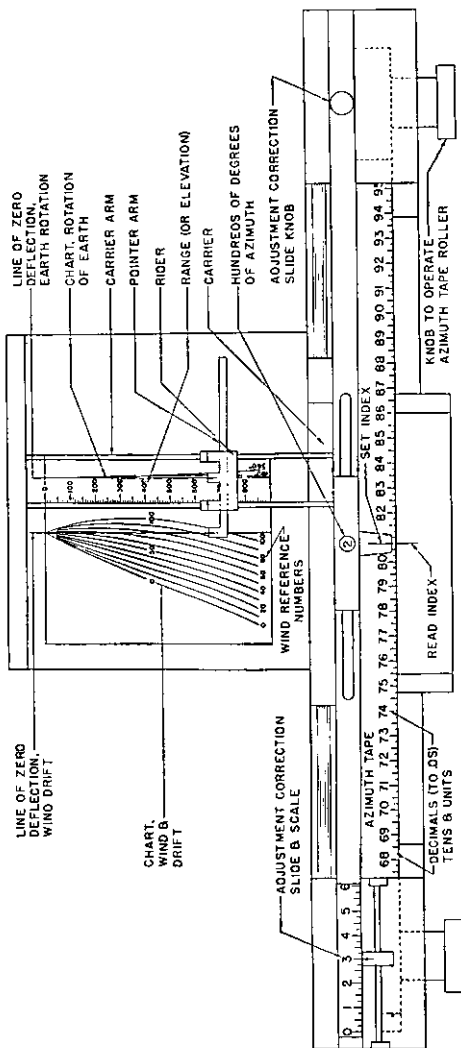

FIGURE 75.—Universal deflection board—schematic diagram.

vertical arm the rider, which may be moved along that arm to bring the pointer arm to the proper range or elevation line. Curves for rotation corrections are fixed to the carrier arm. The pointer arm slides laterally in the rider. It bears two pointers, one for use with the wind and drift curves and the other for use with the rotation curves. The slide is mounted on the lower part of the board, independently of the carrier. It may be moved laterally across the board. The slide bears on its left end the adjustment correction scale and at its center the uncorrected azimuth (or deflection) index, marked **SET INDEX** in the figure. Also, at the center of the slide is a slot and window for a scale with numbers from 1 to 6. These are used with certain azimuth tapes to indicate the hundreds digit (for degrees) or the thousands digit (for mils). The corrected azimuth index, marked **READ INDEX** is on the lower extension of the carrier.

b. Azimuth indicating device.—Uncorrected azimuths (or deflections) are set on the azimuth tape opposite the set index fastened to the slide. Corrected azimuths (or deflections) are read on the azimuth tape opposite the read index fastened to the carrier. Several types of tapes are furnished as follows:

(1) *For azimuths in degrees and hundredths.*—These tapes are furnished in two different scales. One tape is graduated to a scale of 1 inch= 1° , $\frac{1}{20}$ inch equivalent to 0.05° which is the least reading. The tape covers 360° . The second tape is graduated to a scale of 1 inch= 0.5° , $\frac{1}{10}$ inch being equivalent to 0.05° , the least graduation. This scale covers 100° and indicates the tens, units, and hundredths of degrees of azimuth. The hundredths of degrees are shown in a circular window over the set index. A slide marked with numbers from 1 to 6 (see (2) below) slides laterally in a groove under the window. The hundredths digit is set by moving this slide until the proper figure shows through the window. The illustration in figure 75 shows this latter type in use. The reading of the set index in figure 75 is approximately 280.75° . (Due to the reduced scale of the drawing, the 0.05° graduations are not shown in the figure.) Both tapes carry at one end three deflection scales for use with case II pointing. These scales differ only in the system of reference

numbers used and in the limits of the scales used. The normals are 3.00, 6.00, and 10.00. (See par. 59.) The deflection scales are graduated to the same scale as the azimuth scales with a least reading of 0.05° .

(2) *For azimuths in mils.*—This tape is graduated to a scale of 1 inch=10 mfls with a least reading of 1 mil. Each 10-mil graduation is numbered. The tape covers 6,400 mils and indicates the hundreds, tens, and units of mils of azimuth. The tape also carries at one end two deflection scales for use with case II pointing, each scale being graduated to correspond to the graduations of a particular type of sight. These scales are graduated in mils to the same scale and with the same least reading as the main tape, one having numbers increasing to the left and the other having numbers increasing to the right.

(3) *For azimuths in mils or degrees.*—This tape is a combined tape and includes two azimuth scales, one from 0° to 360° with a scale of 1.78 inches= 1° and the other from 0 to 6,400 mils with a scale of 1 inch=10 mils. There are five case II scales, two graduated in mils and three in degrees. One mil scale uses 0 as the normal and is constructed for sights in which the readings increase as the line of sight turns clockwise. The second mil scale also uses 0 as a normal and is for sights where the readings decrease as the line of sight turns clockwise. There are three scales in degrees, one with 3.00 as normal, one with 6.00 as normal, and one with 10.00 as normal.

c. *Wind and drift computing device.*—Attached to the board are the wind and drift curves which are plotted with elevation (or ranges) as ordinates and the combined effect of wind and drift as abscissas. There is plotted a correction curve for each wind reference number that is a multiple of 10 from 0 to 100. The curves are marked in terms of wind reference numbers with 50 as normal. These curves, as well as the curves for rotation, must be constructed for each particular combination of gun, powder charge, and projectile. (The horizontal scale for construction of these curves is the same as the scale of the tape to be used; that is, either 1 inch= 1° , 2 inches= 1° , or 1 inch=10 mils. The vertical scale is variable.) The wind pointer is on the pointer arm. Cor-

rections for wind, drift, and rotation are applied mechanically by offsetting the carrier. The distance it must be offset to correct for wind and drift for a particular ballistic wind and elevation is the lateral distance between the origin line of the wind curves and the intersection of the wind curve with the elevation line. This is done by use of the wind pointer arm. Starting with the board zeroed (the wind pointer at the line of zero deflection for the wind and drift curves, the rotation of the earth pointer at the line of zero deflection for rotation of the earth, and the set pointer opposite the read pointer), the rider is set to the proper range and the carrier is moved until the wind pointer is at the proper wind curve. The read index will now indicate the azimuth corrected for wind and drift.

d. Rotation computing device.—(1) The rotation curves are attached to the vertical arm of the carrier. They are plotted from firing table data with effects in degrees and hundredths (or mils) as abscissas and with elevations (or ranges) as ordinates. Firing tables have rotation effects listed for target azimuths referred to the north, while the charts for fixed guns are constructed with azimuths referred to the south. The scale of the abscissas and of the ordinates is the same as that of the wind curves. An ordinate scale is fixed to the carrier arm at the left of the chart and may be used for both sets of curves. Each curve is plotted for a particular azimuth of the target and labeled accordingly. These curves are shown, one for 0° and 360° , one for 90° and 270° , and one for 180° . The origin line of the curves is shown at the left of the chart. All curves for positions within the United States are constructed for 30° north latitude. (See note, par 85.)

The effect of rotation for a given elevation and a given azimuth is indicated by the lateral distance between the origin line and the intersection of the azimuth curve with the elevation line. The rotation pointer is on the pointer arm at the right of the wind pointer.

(2) The rotation correction is added algebraically by offsetting the wind pointer by means of the rotation pointer. These pointers are separated by the same distance as the origin lines of the two sets of curves. If the rotation pointer

is moved to the proper azimuth curve, the wind pointer will be moved away from its origin line by the amount of the rotation correction, and it will be necessary to move the carrier by an additional amount to set the wind pointer opposite the proper wind curve. The read index will then indicate the azimuth (or deflection) corrected for wind, drift, and rotation.

e. Adjustment corrections.—Adjustment corrections are applied by moving the slide, thus offsetting the set index. The adjustment correction scale is fixed to the slide, and the correction pointer is fixed to the board. When the set index is at its normal position (on the origin line of the wind and drift curves), the normal (3.00, 0.00, or 0; see following) of the scale should be opposite the correction index. If the scale is set to the adjustment correction ordered, the set index will be offset by the amount of the correction. This necessitates that the azimuth tape be moved accordingly in order to keep the uncorrected azimuth or deflection set opposite the set index. The read index will then indicate the azimuth or deflection corrected for adjustment. (Three adjustment correction scales are furnished, two graduated in degrees and one in mils. The two in degrees are to the scale of 1 inch= 1° , with least reading of 0.05; one is numbered with reference numbers from 0 to 6 with 3.00 as the normal; the other is numbered from 1 to 3 on either side of the 0.00 normal. The mil scale is graduated to a scale of 1 inch= 10 mils, extending 30 mils either side of the normal, which is 0. The selected scale must be fixed to the slide in the proper position.)

f. Travel corrections.—When using this board for case II pointing, the correction for angular travel is computed on the angular travel computer (par. 101) or a similar instrument. This value is set opposite the set index on the deflection board, using the deflection scale on the tape that is appropriate for the particular gun sight being used. The corrections for wind, drift, and rotation are applied in the same manner as described in *c* and *d* above.

■ 98. ZEROING.—The zeroing of the board consists of establishing the proper relationships between all pointers and

indexes at their normal positions. The steps in establishing these are as follows:

a. Move the pointer arm until the rotation pointer is opposite the origin of the rotation curves.

b. Move the carrier until the wind and drift pointer is opposite the origin of the wind and drift curves.

c. Move the adjustment correction slide until the set index is directly over the read index.

d. Place the adjustment correction pointer opposite the normal of the adjustment correction scale.

■ 99. OPERATION.—*a. Case II pointing.*—The operator of the board wears a telephone head and chest set connecting him to the gun pointers at the guns. The following are the steps in the operation of the board:

(1) Insert the proper scales and charts.

(2) Zero the board (see par. 98).

(3) Move the deflection tape until the uncorrected deflection called by the operator of the angular travel computer is under the set index.

(4) Move the rider until its index is opposite the corrected elevation or range as called out by the operator of the range percentage corrector.

(5) If a correction for rotation is to be made, move the pointer arm until the rotation pointer is at the curve of the target azimuth of the set-forward point.

(6) Move the carrier until the wind and drift pointer is at the curve of the deflection wind component, as shown by the wind component indicator.

(7) Move the correction slide until the fire adjustment correction ordered is opposite the adjustment correction index.

(8) Reset the uncorrected deflection under the set index.

(9) Call the corrected deflection to the guns at the proper intervals.

(10) Whenever a new adjustment correction is ordered, call out, "Correction applied," after the first reading incorporating that correction is actually sent to the guns.

b. Case III pointing.—The only variation for case III pointing is in the initial setting. In this case the operator sets

the uncorrected azimuth (as called out by the plotter) opposite the set index.

■ 100. ACCURACY TESTS.—The accuracy of the correction curves may be checked by data taken from the firing tables.

SECTION III

ANGULAR TRAVEL COMPUTER

■ 101. DESCRIPTION.—*a.* The angular travel computer (fig. 76) is used with case II pointing to determine, in reference

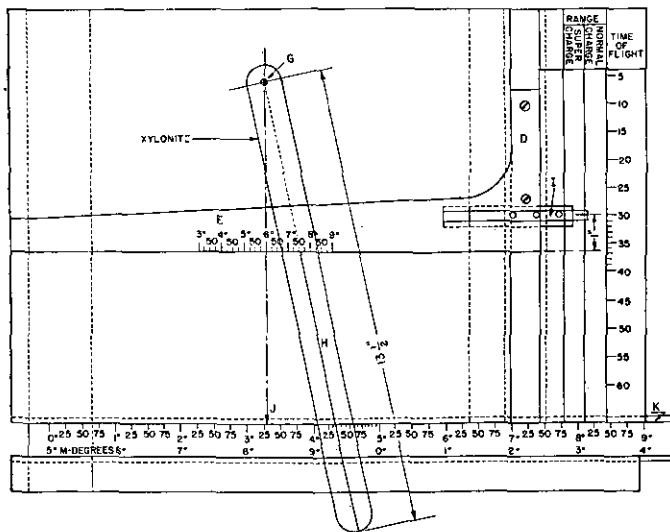

FIGURE 76.—Angular travel computer.

numbers, the uncorrected deflection; that is, the correction for angular travel of the target during the time of flight. This correction is then used on the Universal deflection board. The instrument is not an article of issue and is made locally if needed.

b. (1) The board operates on the principles of similar triangles and solves mechanically the following proportion:

travel during the time of flight is to travel during the observing interval as the time of flight is to the observing interval. The board consists of a movable platen scale *K* on which is set the travel during the observing interval; the deflection scale *E* on which appears the travel during the time of flight; a range-time scale on which is set the time of flight; and a travel arm *H*. The median line, *G-J*, represents the observing interval. The platen scale *K* is graduated in degrees and is movable so that the uncorrected azimuth may be set at *J* on the median line. The travel arm *H* is set along the platen scale to the next uncorrected azimuth received from the plotter. This sets up one triangle with the horizontal side proportional to travel during the observing interval and vertical side proportional to the length of the observing interval. The deflection scale *E* is then set at the range to the set-forward point (as indicated on the range scale), making the vertical side of the second triangle proportional to the time of flight. The horizontal side is therefore proportional to the travel during the time of flight. The deflection scale *E* is graduated and marked in deflection reference numbers with the normal at the median line of the board.

(2) The instrument illustrated is constructed with the platen scale at a fixed distance from *G* equal to 60 seconds on the range-time scale. The length of the observing interval thus represented depends on the ratio of the platen scale to the deflection scale. For example, in the figure that ratio is equal to $\frac{1}{3}$. The observing interval is therefore equal to $\frac{1}{3} \times 60$ seconds = 20 seconds.

(3) For each particular combination of gun, powder charge, and projectile, a range scale is constructed to show ranges corresponding to the times of flight shown on the time of flight scale. This range scale is inserted in its proper position with respect to the time of flight scale shown.

(4) The platen scale is graduated in units and hundredths of degrees of azimuth with a least reading of 0.05° . By dropping the hundreds and tens of degrees and setting only the units and hundredths, a scale of 9° long may be used for setting all azimuths.

■ 102. OPERATION.—The steps in the operation are as follows:

a. Move the platen scale until the azimuth of the old set-forward point, called out at the plotting board, is at the index *J*.

b. Move the travel arm to the azimuth of the new set-forward point.

c. Move the deflection scale to the range to the new set-forward point.

d. Call out to the operator of the universal deflection board the uncorrected deflection as indicated on the deflection scale by the travel arm.

e. Repeat this procedure for each set-forward point.

SECTION IV

DEFLECTION BOARD M1

■ 103. GENERAL.—*a. Standard direction correction device.*—The deflection board M1 is the present standard direction correction device for guns in seacoast artillery. This board is designed for use with either case II or case III pointing and can be used for calculation of direction data in mills as well as degrees.

b. Sectors of operation.—So far as concerns operation, the board may be divided into three sectors (see fig. 77). The input sector contains the wind resolving mechanism, the azimuth setting mechanism, the ballistic chart, and the wind and rotation pointers. The output sector, case III, includes the displacement corrector, azimuth reading mechanism, and adjustment correction mechanism. The output sector, case II, includes the travel and deflection mechanisms.

c. Figure 77 is lined to show the sectors into which the deflection board may be divided for grouping its operational features. On the bottom is the input sector for both case II and case III pointing. On the top is the output sector, case III, while on the right is the output sector, case II.

■ 104. DESCRIPTION OF BOARD.—*a. Azimuth mechanism.*—(1) As issued, the board is set up for use either in degrees or mills. The board can be converted from one to the other by

substitution of the alternate set of gears, reversal of the main and auxiliary azimuth scales and the adjustment correction scale, and substitution of a new ballistic correction chart. The method by which this is accomplished is explained in paragraph 108. The following discussion assumes a board set up for operation in degrees.

(2) The main azimuth plate (1) (fig. 77) rotates freely around the pintle at the center of the board. Large move-

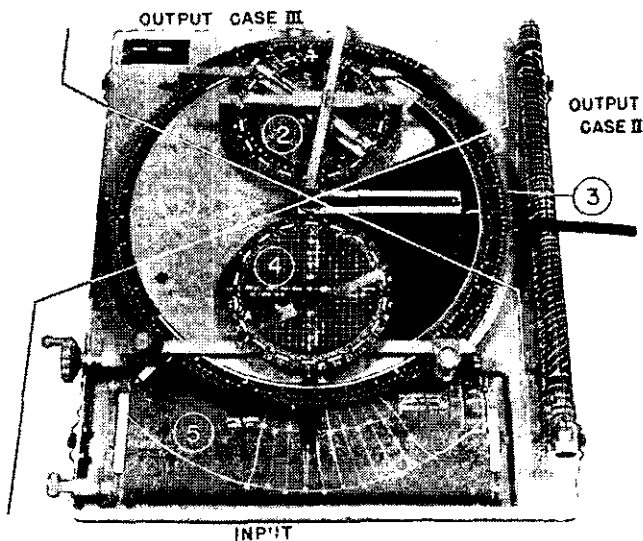

- | | |
|--------------------------------|------------------------------|
| 1. Main azimuth plate. | 3. Deflection scale. |
| 2. Displacement corrector. | 4. Wind resolving mechanism. |
| 5. Ballistic correction chart. | |

FIGURE 77.—Deflection board M1 (sectors of operation).

ments may be made by using the finger holes or by pressing the hand on the plate and moving the hand in the desired direction of rotation, while small movements are made by turning the azimuth knob (15) (fig. 78).

(3) The main azimuth scale (1) (fig. 78) is mounted on the main azimuth plate and is divided into four quadrants, each graduated to represent 10° . (See fig. 77.) Hence one

revolution of the plate covers 40° . Decimal parts of degrees are marked on the scale in $.05^\circ$ graduations. The auxiliary azimuth scales (2) (fig. 78), one of which is engraved on the base plate of the wind resolving mechanism and the other on the base plate of the displacement corrector, are divided into 36 parts, each part indicating 10° . The auxiliary azimuth scales are graduated to read azimuths to the nearest 10° . The main azimuth plate is geared to the base plates

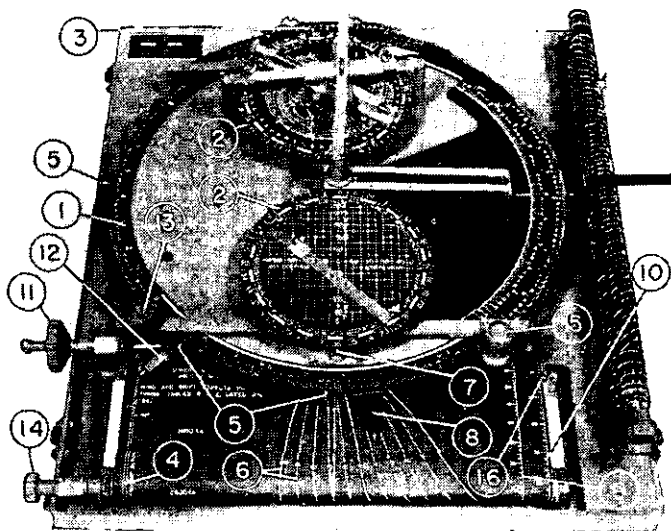

- | | |
|----------------------------------|---------------------------------|
| 1. Main azimuth scale. | 9. Time-of-flight scale. |
| 2. Auxiliary azimuth scales. | 10. Elevation (or range) scale. |
| 3. Auxiliary azimuth read index. | 11. Wind handwheel. |
| 4. Rotation curves. | 12. Rotation pointer. |
| 5. Main azimuth set indexes. | 13. Rotation knob. |
| 6. Wind and drift curves. | 14. Chart knob. |
| 7. Auxiliary azimuth set index. | 15. Azimuth knob. |
| 8. Wind pointer. | 16. Elevation (or range) index. |

FIGURE 78.—Deflection board M1.

on the wind resolving and displacement correction mechanisms in a ratio of 9 to 1. (See figs. 79 and 80.) In other words, the main azimuth plate must revolve nine times to accomplish one revolution of the auxiliary azimuth scales.

When the board is set up for operation in mils, the gear ratio is 8 to 1, since the main azimuth scale is divided into eight sectors of 100 mils each and the auxiliary azimuth scales have 64 parts, each representing 100 mils.

(4) The azimuth to the set-forward point is set into the board using indexes (14) and (16) (fig. 81). In figure 81 the board is set to an azimuth of 267.48° . The digits 26 appear on the auxiliary scale and the remaining digits 7.48 appear on the main azimuth scale. Similarly, the corrected azimuth

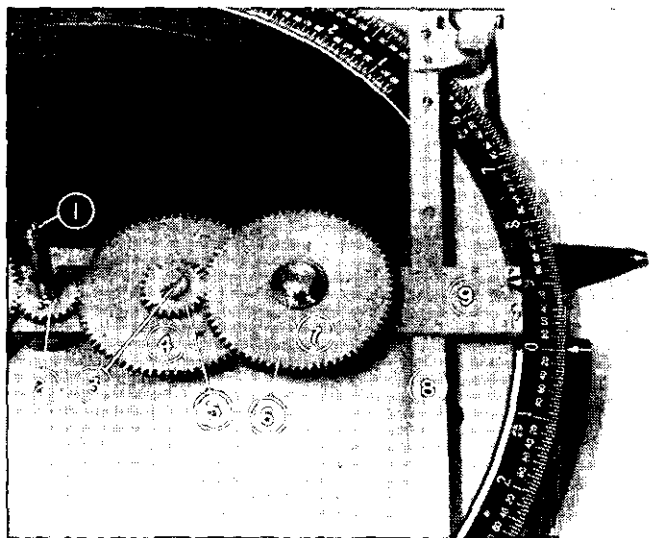

- | | |
|---------------------------|------------------------------------|
| 1. Pintle. | 6. Wind resolving mechanism shaft. |
| 2. Main pinion gear. | 7. Auxiliary spur gear. |
| 3. Pinion screw. | 8. Set arm support. |
| 4. Main spur gear. | 9. Set arm. |
| 5. Auxiliary pinion gear. | |

FIGURE 79.—Gears, input side—wind resolving mechanism and travel arm removed.

NOTE.—The auxiliary pinion gear and auxiliary spur gear shown here are for use only when the board is set for operation in degrees. The meshing of the gears, as indicated by the stars, allows the baseplate of the wind resolving mechanism to be mounted so that the auxiliary azimuth set index will indicate 0° (the line midway 35 and 0 on the auxiliary azimuth scale).

from the directing point to the target (for case III pointing) is read from the board by means of indexes (13) and (21) (fig. 86). In figure 86 the indicated corrected azimuth is 252.62° . To assist the operators in setting and reading azimuths, each 10° interval on both the main and auxiliary azimuth plates is marked alternately black and white. With a properly assembled board, both the auxiliary and main azimuth setting indexes should be read in sectors of the same color.

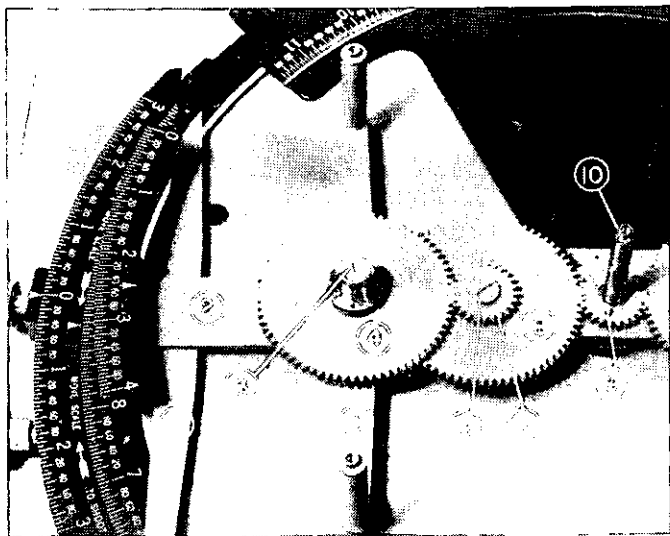

- | | |
|-------------------------|---------------------------|
| 1. Read bar support. | 6. Pinion screw. |
| 2. Read bar. | 7. Auxiliary pinion gear. |
| 3. Shaft screw. | 8. Main spur gear. |
| 4. Auxiliary spur gear. | 9. Main pinion gear. |
| 5. Guide bar support. | 10. Pintle. |

FIGURE 80.—Gears, output side—displacement corrector removed.

NOTE.—The auxiliary pinion gear and auxiliary spur gear shown here are for use only when the board is set up for operation in degrees. The meshing of the gears, as indicated by the arrows, allows the base plate of the displacement corrector to be mounted so that the auxiliary azimuth read index will indicate 0° (the line midway between 35 and 0 on the auxiliary azimuth scale).

(5) Three set indexes are provided for the main azimuth scale. No. 5, figure 83, is ordinarily used. But in case II pointing, this index may be covered by another scale. Should this occur, the operator may immediately switch to index

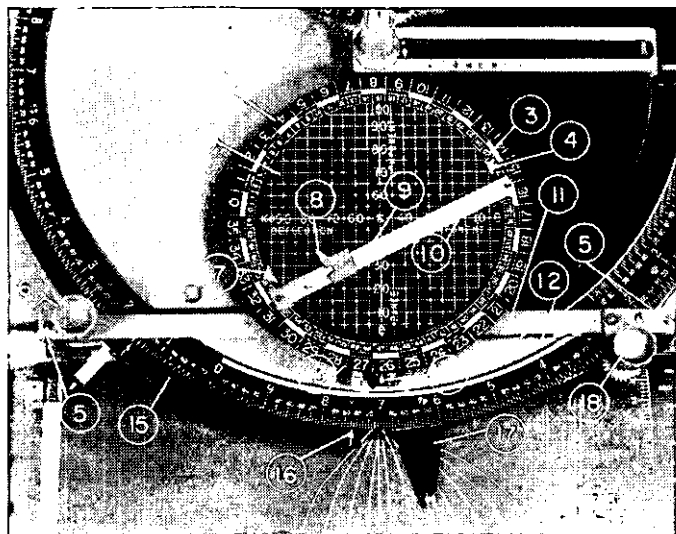

1. Top plate (engraved with grid representing range and deflection components of the ballistic wind).
2. Baseplate (carries auxiliary azimuth scale, 13, and wind azimuth scale, 3).
3. Wind azimuth scale (associated with wind azimuth pointers; see 4 and 7).
4. Wind azimuth pointer (to be utilized by batteries oriented from south).
5. Set arm support end screws (see 11).
6. Rotation knob.
7. Wind azimuth pointer (to be utilized by batteries oriented from north).
8. Wind read pointer.
9. Wind speed scale.
10. Wind arm.
11. Set arm support (for set arm see 9, fig. 79).
12. Main azimuth plate.
13. Auxiliary azimuth scale (associated with auxiliary azimuth set index, see 14).
14. Auxiliary azimuth set index.
15. Auxiliary arc.
16. Primary main azimuth set index.
17. Wind pointer.
18. Azimuth knob.

FIGURE 81.—Wind resolving mechanism.

No. 1, figure 83. Index No. 4, figure 83, could be used in this situation, but since this requires rezeroing the board or adding 4° to each azimuth set in, it is not recommended.

b. Wind resolving mechanism.—(1) The wind resolving mechanism (see fig. 81) is designed to convert the ballistic wind into its range and deflection components. Its principal advantage over the old wind component indicator is that the required azimuth of the set-forward point is automatically put in by setting the main and auxiliary azimuth scales.

(2) The baseplate bears an auxiliary azimuth scale and is geared to the main azimuth plate. When operated in degrees the baseplate rotates with the main azimuth plate in a fixed ratio of nine revolutions of the main azimuth plate to one revolution of the baseplate, as described in *a* (3) above. A wind azimuth scale (3) in hundreds of mils is also engraved on the baseplate.

(3) The wind arm (10) is attached to the baseplate (2) through a slip friction device (see 4, fig. 82) allowing manual rotation of the arm about the center of the base plate without rotation of the plate, but causing the wind arm to rotate with the baseplate. A wind speed scale (9) is engraved on the wind arm and the arm carries a sliding wind read pointer (8) for setting wind speeds and reading wind components. The arm is provided with a wind azimuth pointer at each end for use in setting the azimuth of the wind. Batteries oriented from south must use the pointer (4) farthest from the wind speed scale. In other words, if the battery is oriented from south, use the pointer at the smooth end of the arm, SOUTH, SMOOTH. Batteries oriented from north must use the pointer (7) nearest the wind speed scale. The azimuth of the ballistic wind is set in hundreds of mils clockwise from north as taken from the meteorological message.

(4) The top plate (1) is nonrotatively mounted and is engraved with cross section lines marked in wind reference numbers. The wind arm is set to the proper ballistic wind direction, and the notched edge of the sliding wind read pointer is set to the speed of the ballistic wind. The azimuth of the set-forward point having been set into the board, the range and deflection components may be read from the point

at which the wind read pointer falls on the cross section lines on the top plate.

c. *Ballistic correction mechanism.*—(1) Corrections for wind, drift, and rotation are set into the board by means of the ballistic correction mechanism. It consists of a ballistic correction chart (5) (fig. 77), wind pointer (8) (fig. 78), wind handwheel (11) (fig. 78), rotation pointer (12) (fig. 78), auxiliary arc (2) (fig. 83), rotation knob (3) (fig. 83), an azimuth read index, and two lock knobs (20), (22) (fig. 86).

(2) The ballistic correction chart is mounted on two rollers

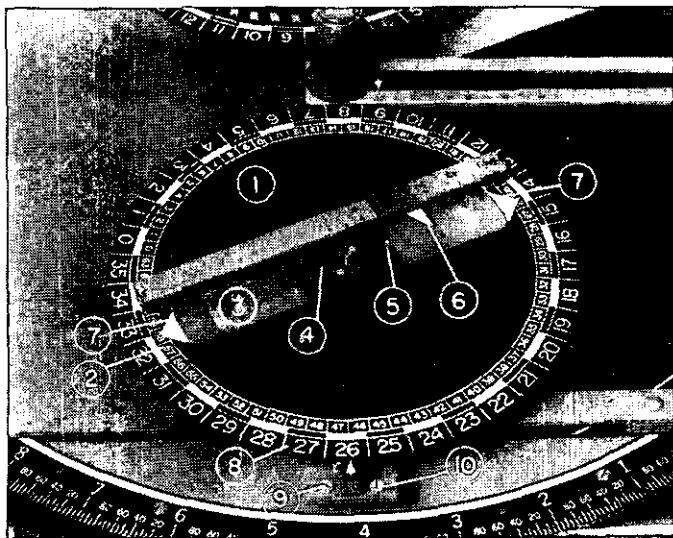

1. Baseplate.
2. Wind azimuth scale.
3. Wind arm.
4. Clip spring (slip friction device).
5. Wind arm pin (note how slot in clip spring engages this pin).
6. Wind read pointer.
7. Wind azimuth pointers (pointer farthest from the wind speed scale is for batteries oriented from south, while the pointer nearest the wind speed scale is for batteries oriented from north).
8. Auxiliary azimuth scale.
- 9 and 10. Index screws (auxiliary set index).

FIGURE 82.—Wind resolving mechanism (top plate removed).

(see fig. 84) spaced apart on the roller base plate (3) (fig. 85), which, in turn, is fixed to the base of the instrument in such manner that the position of the roller assembly may be varied within small limits.

(3) The driving roller (5) (fig. 84), is actuated by turning the ballistic chart knob (3) (fig. 84), and imparts motion to the spring roller (8) (fig. 84), through a chain (10) (fig. 83). The spring roller may be rotated independently of the drive roller to procure tension on the mounted ballistic chart. The

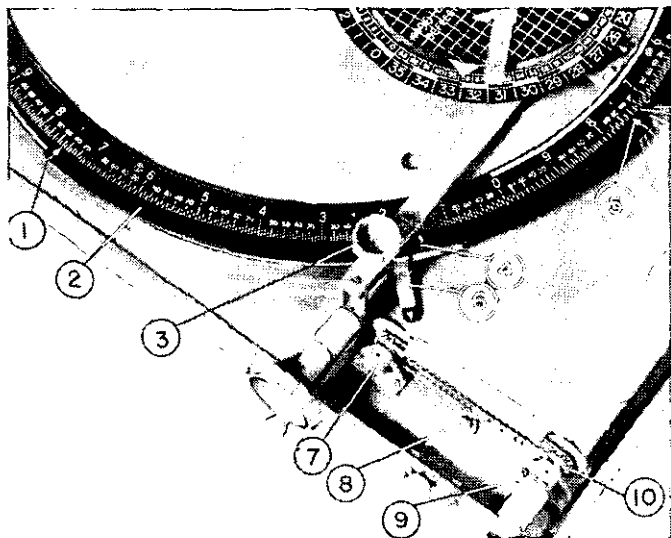

1. Main azimuth set index (10° clockwise from primary main azimuth set index, see 5).
2. Auxiliary arc.
3. Rotation knob.
4. Main azimuth set index (4° clockwise from primary main azimuth set index, see 5).
5. Primary main azimuth set index.
6. Rotation pointer (note that this particular ballistic correction chart, which is for 155-mm gun, carries no rotation curves).
7. Roller end bracket, spring roller.
8. Baseplate screw.
9. Roller end bracket, drive roller (note roller end-bracket screws fixing brackets to the baseplate).
10. Sprocket chain.

FIGURE 83.—Auxiliary arc and ballistic correction chart assembly.

ballistic chart knob is hinged to its shaft and has a knurled sleeve (5) (fig. 85), which may be slid over the hinge to make the knob operative. Before the cover is placed on the board, the sleeve must be slid in to allow the knob to be swung inward so as not to interfere with the cover.

(4) The ballistic correction chart is mounted on the rollers to allow setting the proper range or elevation arc under the wind and rotation pointers. (See fig. 78.) Each chart is prepared for a particular combination of gun and ammunition. Wind and drift curves are drawn representing the combined lateral effects of wind and drift with effects as abscissas and ranges or elevations as ordinates. On its left side, the

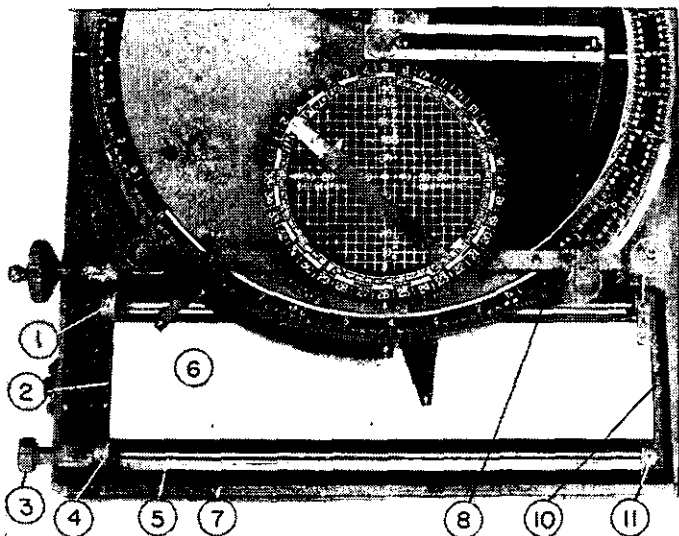

- | | |
|---------------------------------------|---------------------------------------|
| 1. Roller end bracket, spring roller. | 6. Chart plate. |
| 2. Baseplate screw. | 7. Side plate. |
| 3. Chart knob. | 8. Spring roller. |
| 4. Roller end bracket, drive roller. | 9. Roller end bracket, spring roller. |
| 5. Drive roller. | 10. Baseplate screw. |
| | 11. Roller end bracket, drive roller. |

FIGURE 84.—Ballistic correction chart assembly—chart removed.

chart bears similarly plotted curves for the lateral effects of rotation of the earth. An elevation index (16) (fig. 78), is mounted at the upper right-hand corner of the chart plate (6) (fig. 84), and the chart has an elevation or range scale (10) (fig. 78), on its right side. Next to that a time-of-flight scale (9) (fig. 78), is plotted.

(5) The wind pointer (17, fig. 81) is pivoted at the pintle of the board and consequently moves in an arc across the face of the chart. Movement is imparted to the wind pointer by turning the wind handwheel. The wind handwheel is hinged to its shaft and is provided with a knurled sleeve (1, fig. 85) allowing the handwheel to be swung in for putting on the cover. When the cover is removed, the handwheel may

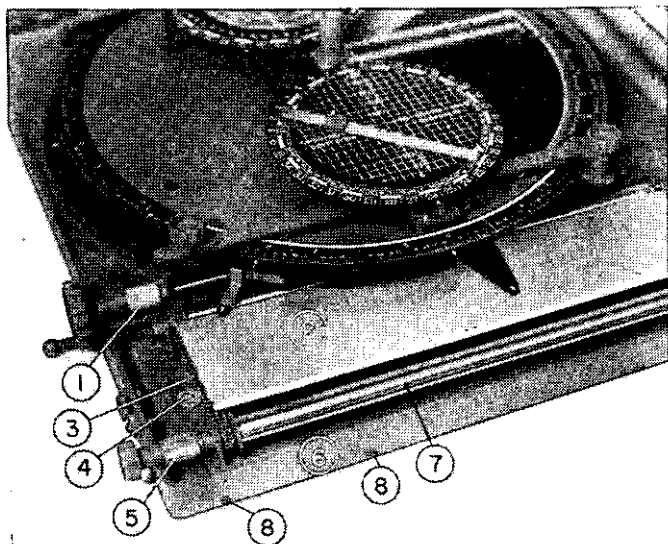

- | | |
|--|--|
| 1. Knurled sleeve, wind handwheel (in operating position). | 4. Baseplate screw. |
| 2. Chart plate. | 5. Knurled sleeve, chart knob (in operating position). |
| 3. Roller baseplate. | 6. Side plate. |
| | 7. Drive roller. |
| | 8. Side plate screws. |

FIGURE 85.—Ballistic correction chart assembly—left side, chart removed.

be placed in operating position and held there by sliding the sleeve over the hinge.

(6) When the wind lock knob and the adjustment lock knob are both tightened, the wind pointer is engaged with the azimuth read index and deflection scale (3) (fig. 88). Angular displacement of the wind pointer causes corresponding angular displacement of the azimuth read index and deflection scale. When either of the lock knobs is loosened, movement of the wind pointer is not transmitted to the azimuth read index. The wind lock knob is used only in zeroing. (See pars. 107b (2) and 107c (2).)

(7) Correction for rotation of the earth is put into the board by turning the rotation knob (13) (fig. 78) to position the rotation pointer on the proper rotation curve. These curves are constructed for a certain latitude and the curves are labeled in azimuths measured from south. Since the rotation pointer (6) (fig. 83) is fixed to the auxiliary arc bearing the set indexes (5) (fig. 78), movement of the rotation pointer causes corresponding angular displacement of these indexes. Consequently, any change in the position of the rotation pointer after setting the target azimuth requires resetting of the azimuth to compensate for displacement of the set index.

d. Lateral adjustment mechanism.—Corrections for lateral adjustment are applied by loosening the adjustment lock knob (20) (fig. 86) and moving the adjustment scale until the proper correction is indicated at the index. The adjustment correction is algebraically added to the ballistic corrections, since movement of the adjustment scale causes the azimuth read index to move an equal amount.

e. Displacement corrector.—(1) The deflection board M1 is provided with a device for determining parallax correction for a displaced gun up to a linear displacement of 500 yards and a parallax correction of 2° . The displacement corrector operates through computation of an approximate graphical solution.

(2) The displacement corrector consists of a baseplate geared to the main azimuth plate in the same ratio (1 to 9) as the baseplate on the wind resolving mechanism. The read auxiliary azimuth scale is marked on this baseplate. The gun

arm (16) (fig. 87) is mounted on a vertical shaft (3) (fig. 80) attached to a bar (2) (fig. 80) pivoted at the pintle set screw (10) (fig. 87). The gun arm is provided with an azimuth index (4) (fig. 87) so that it may be set to the azimuth of the displaced gun using the auxiliary azimuth scale.

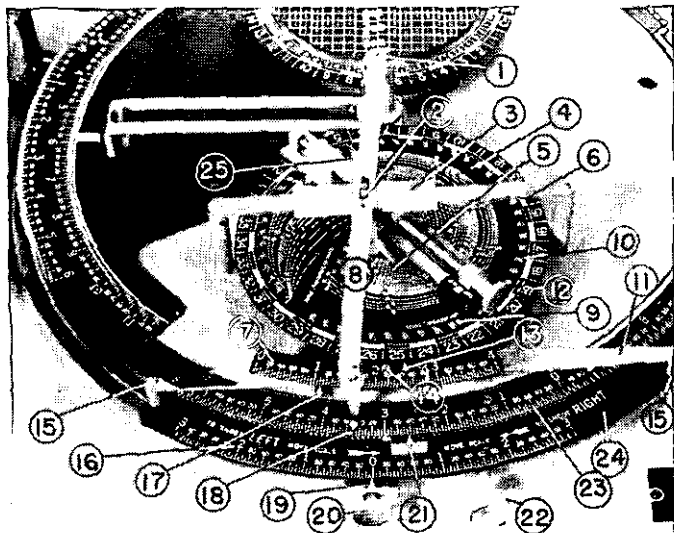

- | | |
|---|---|
| 1. Pintle screw. | 14. Index screws (auxiliary read index). |
| 2. Top slide pin. | 15. Read arm support end screws (see 11). |
| 3. Top slide (axis coincident with axis of guide bar, see 6). | 16. Adjustment correction scale. |
| 4. Curve disk (top plate). | 17. Parallax index. |
| 5. Range pointer. | 18. Read index, displaced gun. |
| 6. Guide bar. | 19. Adjustment correction index. |
| 7. Parallax scale. | 20. Adjustment lock knob. |
| 8. Parallax arm. | 21. Main azimuth read index. |
| 9. Displacement index. | 22. Wind lock knob. |
| 10. Displacement scale. | 23. Main azimuth scale. |
| 11. Read arm support. | 24. Read index plate. |
| 12. Auxiliary azimuth scale (base plate). | 25. Bottom slide (axis perpendicular to guide bar). |
| 13. Auxiliary azimuth read index. | |

FIGURE 86.—Displacement corrector, azimuth read and adjustment correction mechanisms.

(3) The curve disk (4) (fig. 86) is mounted between the baseplate and the gun arm. The disk carries a series of target range curves, and linear displacements are engraved on the periphery of the disk (10) (fig. 86). In operation, the gun arm is set at the azimuth of the displaced gun and locked, and the curve disk is rotated to bring the proper linear displacement under the displacement pointer (9) (fig. 86) on the gun arm. Thereafter the disk will revolve with the baseplate and gun arm and is thus kept properly oriented in azimuth. The target range must be set into the corrector by

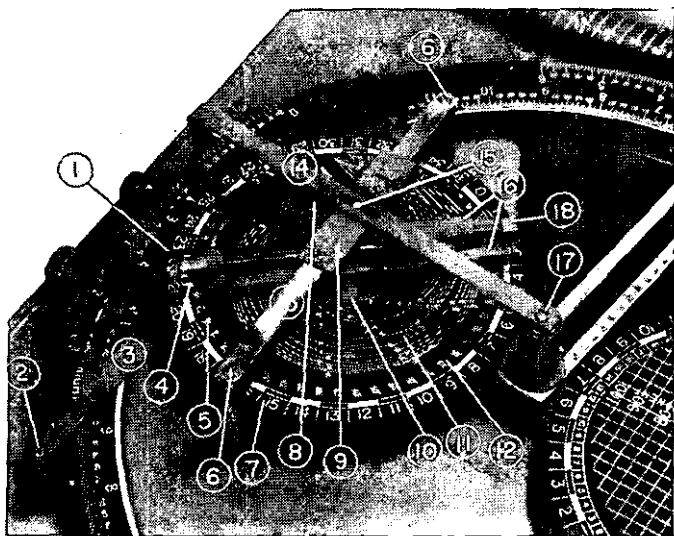

- | | |
|--|-----------------------------|
| 1. Range knob. | 10. Gun arm set screw. |
| 2. Set arm support and screw. | 11. Range curves. |
| 3. Set arm support. | 12. Curve disk (top plate). |
| 4. Gun arm azimuth index. | 13. Guide bar. |
| 5. Displacement scale. | 14. Parallax arm. |
| 6. Guide bar screws. | 15. Top slide pin. |
| 7. Baseplate. | 16. Gun arm. |
| 8. Bottom slide (axis perpendicular to that of guide bar). | 17. Pintle screw. |
| 9. Top slide (axis coincident with that of guide bar). | 18. Range screw block. |

FIGURE 87.—Displacement corrector.

keeping the gun arm range pointer (5) (fig. 86) positioned on the proper range curve. This is accomplished by turning the range knob (1) (fig. 87).

(4) The gun arm is provided with double range screws of different pitch, so that when the range knob is turned, the range pointer moves twice as far as the gun arm pin representing the displaced gun. This is done to prevent crowding the curves on the range disk. The settings of displacement, azimuth of the displaced gun, and range position the pin (15) (fig. 87) on the top slide (9) (fig. 87), causing the parallax arm (14) (fig. 87) to rotate about its pivot at the pintle of the board. The corrected azimuth for the displaced gun may be read from the main azimuth scale at the lower index of the parallax arm (18) (fig. 86) in conjunction with the auxiliary azimuth scale and index. The displacement corrector is also provided with a parallax scale (7) (fig. 86) which is engraved on the plate carrying the auxiliary azimuth read index. This scale, together with the parallax index (17) (fig. 86) (upper index on the parallax arm), was designed to enable direct parallax readings where a data transmission system is used. However, the parallax scale in reference numbers with a normal of 2 (as shown in fig. 86) is not suitable for this purpose because it does not agree with the reference number system used on the parallax scale of data transmitters. Recent issues of the deflection board M1 have the parallax scale graduated in the same reference number system as the parallax scale on the data transmitters (a normal of zero). Consequently, where a data transmission system is used, parallax for a displaced gun may be read directly from the new type parallax scale and set on the transmitter. On the older boards the scale may be renumbered to convert it to the reference number system on the parallax scale of the transmitter.

(5) As issued, the displacement correction device is adapted solely for use in degrees for the reason that the curve disk is engraved for operation in degrees only. For adaptation to mil operation, see paragraph 108c. The displacement corrector is not adapted for use in computation of deflection for case II pointing, since effect of displacement is negligible when that case of pointing is used.

f. Angular travel computing mechanism.—(1) The deflection board enables computation of angular travel for case II pointing. The angular travel computing mechanism (fig. 88) consists of the travel arm (1), travel scale (6), travel chart (10), and the deflection arm (8). The travel arm is pivoted at the pintle of the board and is attached to the main azimuth plate by means of a slip friction device which allows movement of the travel arm independent of the main azimuth plate but causes the arm to move with the main azimuth plate within the limits of movement of the arm. A travel scale is fixed to the travel scale plate (2) and is graduated in reference numbers with a normal of 6.00. While the scale used in graduating the travel scale is the same as that used in graduating the main azimuth scale for degree operation, there need be no interrelation between these two scales. Consequently, the same travel scale suffices for operation in both degrees and mils.

(2) The travel arm, in conjunction with the travel scale, serves merely as a subtraction device for obtaining the difference between successive azimuth readings. This difference is read on the travel scale in reference numbers. Numbers greater than six represent travel to the right while those less than six represent travel to the left.

(3) The main azimuth circle having once been set to the uncorrected target azimuth and the travel arm set to normal on the travel scale, the next uncorrected target azimuth is set. The travel arm moves with the main azimuth plate, and its displacement will equal the angular travel of the target during the observing interval. This angular travel is read on the travel scale. The travel arm is then reset at normal in preparation for the next angular travel reading.

(4) Angular travel during the observing interval, as read from the travel scale, must be converted into angular travel during time of flight in order to compute deflection. This is accomplished through use of the travel chart and deflection arm. The travel chart is carried on two rollers, one being a drive roller and the other a spring roller. The rollers are connected by means of a sprocket chain. The chart has two time-of-flight scales plotted near the left edge (see fig. 77). One time-of-flight scale is based on a 20-second

observing interval and the other on a different observing interval (15 seconds on the newer charts). In addition, three blank columns are provided, one for plotting times of flight, and two for plotting ranges corresponding to times of flight shown in any of the time-of-flight columns. The chart may be rolled until the proper time of flight (obtained by reference to the time-of-flight scale on the ballistic chart), in the column for the observing interval being used, is under the cross wire (12). This positions the chart in the scale of ordinates.

(5) The travel chart also bears travel curves plotted on either side of the straight 6.00-normal line and marked in the same reference number system found on the travel scale.

(6) The travel chart having been rolled, as described, to the time of flight for the corrected range or elevation, the point of intersection of the cross wire with the travel curve bearing the same reference number as that previously read from the travel scale is noted. Next, the deflection arm, which is pivoted at the pintle, is moved so that its beveled reading edge (7) falls over this point of intersection.

g. Deflection computing mechanism.—(1) With the wind lock knob and adjustment lock knob engaged, movement of the wind pointer is communicated to the deflection scale. Changes in position of the adjustment correction scale with respect to the adjustment correction index are similarly communicated to the deflection scale. Hence, the corrections for wind, drift, and adjustment are introduced by scale displacement.

(2) The correction for travel of the target is algebraically added to the correction for wind, drift, and lateral adjustment by displacement of the deflection index (4) (fig. 88) which is carried on the deflection arm. It will be remembered that the arm has been displaced in accordance with the travel by setting it to the proper travel curve. The algebraic addition of corrections for wind, drift, lateral adjustment, and travel is thus accomplished to allow reading of the deflection as indicated by registration of the deflection index on the deflection scale.

(3) Four deflection scales are provided for use on the

board. For operation in degrees, scales having normals of 3.00, 6.00, and 10.00 are provided. The scale to use is that having the same normal as the sighting equipment on the gun. One deflection scale with a normal of 200 is for use when the board is set up for operation in mils. The deflection scale to be used is fastened to the read arm support by means of the two deflection scale screws. A box of spare parts is fixed to the underside of the cover. It contains the deflection scales not in use and the alternate set of gears.

■ 105. MOUNTING THE CHARTS.—*a. General.*—(1) Suitable charts for use on the deflection board M1 may be obtained

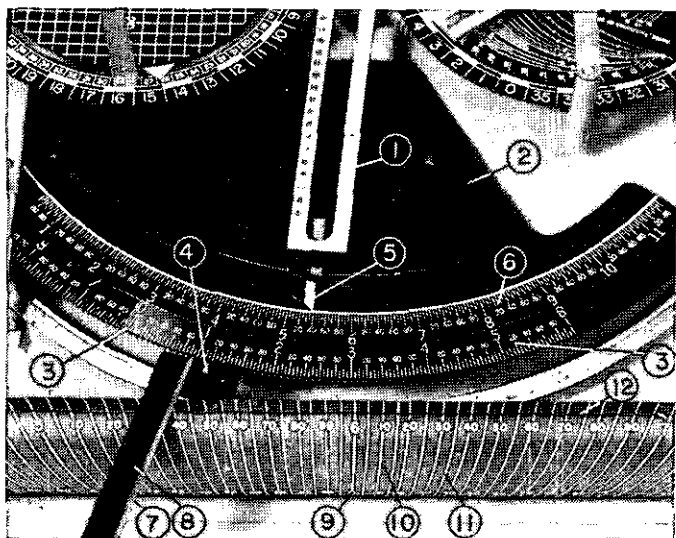

- | | |
|---|----------------------|
| 1. Travel arm. | 8. Deflection arm. |
| 2. Travel scale plate. | 9. 6.00-normal line. |
| 3. Deflection scale. | 10. Travel chart. |
| 4. Deflection index. | 11. Travel curves. |
| 5. Travel arm index. | 12. Cross wire. |
| 6. Travel scale. | |
| 7. Reading edge, deflection arm
(the reading edge is beveled). | |

FIGURE 88.—Travel and deflection mechanism.

from the Coast Artillery Board, Fort Monroe, Virginia. (See app. VII for instructions.) *Each ballistic correction chart is designed for a particular combination of gun and ammunition and must be used only with that particular combination.* The angular travel charts need not be replaced because of a change of gun, ammunition, or degree operation.

(2) Where the guns are equipped with range drums and utilize range-range relations on the percentage corrector tape, considerable inaccuracy may result if the corrected range, as read from the percentage corrector, is set on the range scale of the ballistic correction chart. In this case, a new range scale involving the proper range-range relation should be plotted on the ballistic correction chart. The new range scale can be plotted alongside the old scale by getting the corresponding readings from the range-range relation tape on the percentage corrector M1.

b. Ballistic correction chart.—(1) Before mounting the ballistic correction chart, cut it along the side trim lines so as to give the chart the same width as the distance between the shoulders of the rollers. This allows a close fit between the chart and the roller edges, thus preventing creeping of the chart.

(2) Remove the side plate (6) (fig. 85) of the board by taking out the side plate screws (8) (fig. 85). Remove the two ballistic correction chart baseplate screws (2) (10) (fig. 84) and slide out the ballistic correction chart assembly. Lay the chart across the two rollers so that the lower edge coincides with the axis of the drive roller. Fix the lower edge of the chart to the roller, using scotch tape or similar adhesive tape. Maintain a slight tension on the upper edge of the chart at its center and roll the chart smoothly onto the drive roller until the upper edge of the chart coincides with the axis of the spring roller. Roll the spring roller back against the tension of its spring and mount the chart on the roller in a manner similar to that followed with the drive roller.

(3) Mount the ballistic chart assembly on the board and test the positioning of the chart by setting the wind and rotation pointers on their lines of zero deflection and roll the chart a considerable distance. The wind and rotation

pointers should remain on the lines at all times. If this test results satisfactorily, roll the chart until the arc of zero range intersects the wind pointer and move the wind pointer through the complete arc, using the wind handwheel. The pointer ought to follow the arc closely except, perhaps, toward the outer limits of the arc. If results of this test are satisfactory, replace the side plate. To set the elevation index at zero range or elevation, roll the chart to place the zero range or elevation arc at the reading edge of the wind pointer and loosen the index adjusting screws. Now move the index to zero and tighten the screws.

(4) If the wind and rotation pointers fail to remain on their zero deflection lines or the reading edge of the wind pointer fails to follow the arc, loosen the baseplate screws and, by trial and error, attempt to find a position in which the chart will check. If this cannot be done, the chart must be remounted.

(5) Considerable care must be used in positioning all charts on the deflection board M1. Data are put into the board through the medium of these charts, and the performance of the board is dependent upon the charts being correctly positioned.

c. Travel chart.—(1) Before mounting the travel chart, cut it along the trim lines if necessary. Slip the top of the chart under the cross wire and mount the top edge of the chart squarely on the drive roller (upper roller) by means of scotch tape or other adhesive material.

(2) Roll the chart smoothly on the drive roller until the bottom of the chart reaches the center of the outer side of the spring roller (lower roller). Roll the spring roller back against its spring end; holding it in this position, fasten the bottom of the chart to it with scotch tape.

(3) Sometimes it is desired to have the same zero setting for the board for both case III and case II pointing, in order to obtain a quick change from one case to the other. To accomplish this, zero the board for case III (par. 107b (2)) and set the deflection index to the normal on the deflection scale. Slide the travel chart laterally on the drive roller until the 6.00-normal line on the chart falls under the reading edge of the deflection arm and fasten the chart to the

rollers in this position in the manner previously described.

(4) In any case, the mounted travel chart should be tested by placing the reading edge of the deflection arm so it cuts the 6.00-normal line and then rolling the chart through the limits of its movement to make sure that the line remains under the reading edge of the deflection arm. If the chart does not respond to this test, it must be remounted.

■ 106. LATERAL ADJUSTMENT SCALE—REFERENCE NUMBER SYSTEM.—*a.* The deflection board M1 is now being issued with the adjustment correction scale for degrees engraved for a 300-normal system. This is the same reference number system as is utilized on the splash scale of the azimuth instrument M1910A1 and on the lateral adjustment correction scale of the spotting board M3.

b. However, previously the deflection board has been furnished with adjustment correction scales engraved with a zero normal. This necessitates the use of "left" and "right" corrections and may be the cause of considerable confusion and possibly the application of lateral adjustment corrections in the wrong sense. Some batteries have consequently revised the degree adjustment correction scale to a 300-normal system. To accomplish this revision, paste tabs bearing the numbers of the new system over the 1, 2, and 3 on each side of the normal and over the 0. A number 3 is placed over the 0. The numbers 2, 1, and 0 are pasted to the left of 3 over the 1, 2, and 3, respectively, while the numbers 4, 5, and 6 are placed to the right of 3 over the 1, 2, and 3, respectively. Also, the order of the decimal numbers to the left of 3 must be reversed by placing properly numbered strips over these numbers.

c. The adjustment correction scale in mils is not suitable for use on a board otherwise set up for operation in degrees, nor can the degree adjustment scale be used on a board otherwise set up for operation in mils. This is due to the fact that the degree adjustment scale is constructed for a ratio of 9 to 1 while that for mils is constructed for a ratio of 8 to 1. The factor of error would therefore be of the order of 8 to 9. While new mil and degree scales could be constructed for use with a board operating in the other

units, the simplest way to solve the problem is to make the conversion from mils to degrees or vice versa on the lateral adjustment board.

■ 107. OPERATION.—*a. General.*—Operation of the deflection board M1 requires two men. The input operator sits facing the ballistic correction chart for both case II and case III pointing. The output operator is equipped with a telephone allowing him to transmit corrected azimuths or deflections to the azimuth setters or gun pointers at the guns. When operating with case III pointing, the output operator sits facing the output sector, case III (2) (fig. 77), while with case II pointing, he sits facing the output sector, case II (3) (fig. 77). When the displacement corrector is used, a second output operator is required to read and transmit corrected azimuths for the displaced gun.

b. Case III pointing.—(1) *General.*—(a) When the battery is firing case III, the board solves the problem of computation of a corrected azimuth from the directing point to the set-forward point and a corrected azimuth for use at a point displaced from the directing point. In computing the corrected azimuth, corrections to the uncorrected azimuth of the set-forward point may be applied on the M1 board for the following conditions:

1. Wind.
2. Drift.
3. Rotation of the earth.
4. Azimuth difference due to gun displacement.

(b) Provision is also made for the application of lateral adjustment corrections to the data for the directing point and displaced point alike.

(2) *Zeroing the board.*—This involves removing all corrections previously put into the board and making the output side of the board read the same azimuth as the input side. This should be accomplished for the case of pointing to be used each time the range section is posted.

(a) Set the wind pointer to its zero deflection line. This is the straight line running down the ballistic chart usually labeled "ZERO DEFLECTION."

(b) Set the rotation pointer to its zero deflection. Care should be taken not to use the zero degree line.

(c) Loosen the adjustment knob and slip the scale until no correction is indicated. Tighten the adjustment knob.

(d) If the same azimuth is not indicated on the read index as on the set index, loosen the wind lock knob, slip the scale until the readings are the same, and tighten the knob.

(3) *Operation, input operator.*—The input operator operates the wind resolving mechanism and sets the rotation pointer, the wind pointer, and the uncorrected azimuth.

(a) Set the approximate azimuth to the target as received from the plotting board.

(b) Set the wind resolving mechanism, using the azimuth and speed of the wind from the proper line of the meteorological message and read the range component to the range correction board operator.

(c) Set the azimuth to the set-forward point as received from the plotting board.

(d) Position the ballistic chart to either the corrected range or the elevation, as received from the percentage corrector.

(e) Set the wind pointer to the deflection component of the wind.

(f) Set the rotation pointer to the azimuth of the set-forward point.

(g) Reset the azimuth of the set-forward point.

(h) In order to insure smooth data, the input operator should be trained not to disturb the setting of the ballistic correction chart in range or elevation, or the wind and rotation pointers until a perceptible change is required. The habit of touching each knob, when changes in elevation or range are so small as not to warrant any change, is to be discouraged. Unwarranted adjustment results in erratic corrected azimuths.

(4) *Output operator No. 1.*—(a) Transmits to the guns the corrected azimuth from the directing point to the set-forward point when the input operator signals that he is set.

(b) Sets the lateral adjustment corrections when ordered.

(5) *Output operator No. 2.*—Necessary only if the displacement corrector is used.

(a) Initially sets up the parallax mechanism. This consists of—

1. Setting azimuth from the directing point to the displaced gun.
2. Positioning the curve disk to the amount of displacement in yards.

(b) Sets the range pointer to the curve representing the latest map range from the plotting board.

(c) Transmits to the displaced gun the corrected azimuth from that gun to the set-forward point. If the data transmission system is used, he reads the parallax correction from the parallax scale (which, if necessary, must be revised to the same parallax reference number system as that used on the data transmitter) and calls it off to the parallax correction setter at the azimuth transmitter.

(6) *Checking the board.*—In order to insure that the board is turning out correct data, it is necessary to have some means of checking the board. The wind and drift charts should be checked against the firing tables. In the firing tables, drift is given in steps of $.05^\circ$. Since the wind and drift curves are smooth curves, they will not check the firing tables at all ranges. At certain ranges marked on the charts themselves, the curves are known to check the firing tables for which constructed. The charts should be checked at the elevation or range marked thereon. For this range, the correction for some particular value of wind reference number should be computed from the firing tables. If desired, a correction for rotation of the earth for the same range and some convenient target azimuth can also be included. The pointers are then set to the curves corresponding to these corrections, and the difference between the azimuth at the set and read indexes should be equal to the correction computed. On some of the older charts, small circles are drawn to indicate check points and the proper corrections are listed on the chart. These check points may be used if desired, but it should be realized that in using these points the chart assembly is not being checked against the firing tables. To check against the firing table, the corrections should be computed, as outlined above,

for the ranges and wind reference numbers of the check points given. If this check reveals that the board is not giving the proper corrections, the board is out of adjustment or the chart does not correspond to the firing tables. The board should then be examined to see what is causing the error.

c. Case II pointing.—(1) *General.*—(a) With case II pointing, the board enables corrections to be made for the following conditions:

1. Wind.
2. Drift.
3. Travel during time of flight.

(b) These corrections are algebraically added on the board, resulting in the output of deflection. The board also enables introduction of a lateral adjustment correction into this deflection. When operating case II, a correction for rotation of the earth cannot be made, nor can the displacement corrector be used.

(2) *Zeroing the board.*—This involves removing all the corrections and having the deflection pointer indicate the normal of the deflection scale.

(a) Secure the rotation pointer by binding it against its stop. This is never used in case II firing.

(b) Set the wind pointer to its zero deflection line. This is the straight line running down the ballistic chart usually labeled "zero deflection."

(c) Loosen the adjustment knob and slip the scale until no correction is indicated. Tighten the adjustment knob.

(d) Position the beveled edge of the deflection arm to intersect the cross wire on the angular travel chart at the 6.00-normal curve.

(e) Loosen the wind lock knob and move the deflection scale until the normal of the scale is at the deflection pointer. Tighten the wind lock knob.

(3) *Operation, input operator.*—The input operator performs the same duties as for case III pointing, except that he does not apply a correction for rotation of the earth.

(4) *Operation, output operator.*—(a) Sets the travel arm to the normal of the travel scale.

(b) When the input operator sets in a new map azimuth,

notes the reference number on the travel scale to which its arm has moved. Resets the travel arm to normal.

(c) Positions the angular travel chart according to the time of flight taken from the ballistic chart.

(d) Moves the beveled edge of the deflection arm to the curve on the angular travel chart numbered the same as the reference number previously noted on the travel scale.

(e) Sets in a lateral adjustment correction if ordered.

(f) Reads the corrected deflection at the deflection index on the deflection scale and transmits it to the guns.

(g) It must be remembered that the travel reference number indicated on the travel scale represents azimuth difference between successive points. Thus the travel reference number determined between two successive set-forward points or two successive plotted points is reliable. However, when the data for the first set-forward point is determined, it cannot be utilized with the previous data on a plotted point, for the azimuth difference between a plotted point and a set-forward point is no indication of travel of the target as computed on the board.

(5) *Checking the board*—(a) *General*.—Some charts supplied by the Coast Artillery Board for use on the deflection board M1 do not have check data for case II firing. While a check of sorts may be made by following the check procedure given in *b* (6) above for case III pointing and additionally checking the operation of the travel arm, this does not enable an over-all check for case II.

(b) *Locally calculated check data*.—

1. A much more satisfactory procedure is to calculate case II check data from the firing table. For calculation, we must assume speed and direction of the ballistic wind, two azimuths representing the uncorrected azimuth of successive set-forward points, and a corrected range or elevation. A deflection may be calculated. Several sets of data, based on different assumed conditions, should be provided. No rotation correction should be calculated, inasmuch as no correction for rotation may be made on the board in computation of deflections for case II pointing.

2. The sets of check data should be posted near the deflection board so that they can easily be read by the operators without moving from their posts. The posted data should show the speed and direction of the ballistic wind, the two successive uncorrected target azimuths, the corrected range or elevation, and the calculated deflection.
3. Having previously zeroed the board for case II (see par. 107c (2)), the input operator sets the proper wind azimuth pointer to the azimuth of the ballistic wind on the wind azimuth scale. He sets the first target azimuth, utilizing the azimuth set indexes, and then rolls the ballistic correction chart until the range or elevation of the check data, as read on the elevation or range scale, is under the elevation pointer. Then he reads the deflection component, as indicated by the wind pointer on the grid, and sets the wind pointer to the proper curve. (Interpolation may be necessary.) The output operator then reads the time of flight indicated on the time-of-flight scale of the ballistic correction chart by the elevation index and rolls the travel chart until that time of flight in the column for the proper observing interval appears under the cross wire. The output operator sets the travel arm index (5) (fig. 88) to normal on the travel scale. Then the input operator sets the next uncorrected azimuth, and the output operator notes the position of the travel arm on the travel scale and sets the reading edge of the deflection arm to the point where the cross wire falls over the travel curve for the reference number read from the travel scale. The deflection indicated by the deflection index on the deflection scale should be the same as that calculated for the check data; otherwise, the malfunctioning of the board must be remedied.

■ 108. CONVERSION TO OPERATION IN MILS.—*a. Procedure.*—

- (1) In order to convert the deflection board M1 to opera-

tion in mils, all parts above the main azimuth plate must be disassembled. To proceed with this, disassemble the azimuth mechanism as described in paragraph 109 *a* to *c*, inclusive. Next, carefully lift off the main pinion gear (9) (fig. 80). Remove the end screws (5) (fig. 81) on the set bar support (11) (fig. 81), lift the set bar off the pintle bushing and withdraw the set bar assembly which includes the travel scale plate (2) (fig. 88). Remove the end screws (15) (fig. 86) on the read bar support (11) (fig. 86) and lift out the read bar assembly which includes the deflection scale.

(2) Now remove the main azimuth scale screws and reverse the scale to bring the mil scale on top and replace the screws. Replace the read bar assembly and the set bar assembly. Replace the main pinion gear and, if necessary, move main azimuth plate so the arrow on the main pinion gear faces the read bar and the star faces the set bar. Obtain the pinion and spur gears marked "FOR MILS ONLY" from the parts box in the bottom of the cover and reassemble the gears as described in paragraph 109 *e* to *g*, inclusive. Reassemble the displacement corrector and wind resolving mechanism, being careful to replace the baseplates so the auxiliary mil scales (64 divisions) are on the upper side.

(3) Remove the adjustment correction scale screws, reverse the scale, and replace the screws. Remove the deflection scale and mount the scale having a 200 normal. Replace the ballistic correction chart with one constructed for operation in mils.

b. Travel mechanism.—The travel scale and travel chart are suitable for operation in either mils or degrees. Consequently, these are not changed for conversion to operation in mils.

c. Displacement corrector.—The curve disk on the displacement corrector is graduated only for operation in degrees. However, correct parallax will be indicated in mil operation if the setting in yards, utilized to position the curve disk, is taken as the actual displacement multiplied by $\frac{8}{9}$. Otherwise, operation of the board is the same as for degrees.

■ 109. AZIMUTH MECHANISM, CORRECTIVE MEASURES.—*a. Disassembly.*—Remove the top plate screw at the center of the top plate (1) (fig. 81) on the wind resolving mechanism and lift off the top plate, wind arm (10) (fig. 81), and clip spring (4) (fig. 82). Note how the slot in the clip spring fits into the pin (5) (fig. 82) on the wind arm. Then lift off the base plate (1) (fig. 82). Next, remove the auxiliary spur gear (7) (fig. 79).

b. The travel arm (1) (fig. 88) must be removed before the pinion gear and main spur gear can be removed. To remove the travel arm, unscrew the pintle screw (1) (fig. 86), remove the parallax arm (8) (fig. 86), and lift the travel arm (1) (fig. 88) off the spindle (1) (fig. 79). Then, unscrew the pinion screw (3) (fig. 79), and remove the auxiliary pinion gear (5) (fig. 79), and main spur gear (4) (fig. 79).

c. The displacement corrector may now be disassembled (see fig. 87). Remove the guide bar screws (6) and lift off the guide bar (13) and slides (8) (9). Loosen the gun arm setscrew (10) and lift the gun arm (16) off its pivot. Remove the curve disk collar screws and remove the collar. Lift off the curve disk (12) and then lift the baseplate (7) off the shaft. (See fig. 80.) Now remove the shaft screw (3) and lift out the auxiliary spur gear (4). Remove the pinion screw (6) and lift out the auxiliary pinion gear (7) and main spur gear (8). The azimuth mechanism is now completely disassembled.

d. Loosen the wind lock knob (22), (fig. 86) and move the read index plate (24) (fig. 86) until the read bar (2) (fig. 80), bearing the auxiliary and main read indexes, is in approximate prolongation of the set bar (9) (fig. 79) bearing the auxiliary azimuth set index. Tighten the wind lock knob. Now turn the main azimuth plate until the arrow on the main pinion gear (9) (fig. 80) points toward the displacement corrector shaft, and the star on the main pinion gear faces the wind resolving mechanism shaft. The readings opposite the main read and set indexes should now be approximately zero.

e. (See fig. 80.) Replace the main spur gear on the displacement corrector so that the groove marked by the arrow

accommodates the tooth marked by the arrow on the main pinion gear. Mount the auxiliary pinion gear so that the arrow points toward the displacement corrector shaft. Replace the pinion screw. Mount the auxiliary spur gear so the arrowed tooth fits into the arrowed groove on the auxiliary pinion gear and replace the shaft screw. Mount the baseplate on the shaft pins so the auxiliary read index points approximately to zero. Replace the top plate and the collar. Fix the collar by means of the two collar screws. The top plate should be held firmly, but movement should be permitted for setting displacements. Replace the gun arm and tighten the gun arm setscrew. Replace the guide bar, being careful that the pin on the gun arm fits into the slot on the bottom slide. Replace the guide bar screws.

f. (See fig. 79.) Next mesh the main spur gear on the wind resolving mechanism so that its starred groove fits into the starred tooth on the main pinion gear (2). Mount the auxiliary pinion gear so that the starred tooth points toward the wind resolving mechanism shaft (6). Replace the pinion screw. Mesh the auxiliary spur gear with the auxiliary pinion gear so that the starred tooth on the latter engages the starred slot on the former. Mount the baseplate on the shaft pins so that the auxiliary set index points approximately to zero. Replace the wind arm and clip spring, making sure that the slot in the clip spring is engaged on the pin of the wind arm. Slide the top plate between the top and bottom of the wind arm and engage the hole in the top plate on the top shaft pin. Replace the top plate screw. Replace the travel arm, the parallax arm, and the pintle screw.

g. Now set both the read and set indexes at 0° . Both of the auxiliary indexes should point to the line between 35 and 0. This is zero on the auxiliary scale. If this is not the case, loosen the index screws (9) (10) (fig. 82), (14) (fig. 86) on both of the auxiliary indexes and adjust them so that they fall exactly on the line between 35 and 0.

h. If directions have been followed, the assembly of the azimuth mechanism will be correct and no further difficulty should be encountered in the setting and reading of azimuths.

i. The spur gears and pinion gears for use with degrees and mils are so marked on their faces. The proper gears may be further identified by noting the characteristics which are listed below for the gears and pinions designed only for operation in degrees.

Auxiliary spur gears..... 72 teeth.

Auxiliary pinion gears..... 24 teeth.

j. Similar characteristics for the spurs and pinions designed only for operation in mils are:

Auxiliary spur gears..... 56 teeth.

Auxiliary pinion gears..... 21 teeth.

k. On the later boards, the gears for the wind side are marked with stars while those for the displacement side are marked with arrows, as described in *e* and *f* above. On the earlier boards the gears for driving the wind resolving mechanism were marked "W" and those for the displacement corrector were marked "P."

CHAPTER 13

POINTING METHODS AND INSTRUMENTS

	Paragraphs
SECTION I. General	110-113
II. Pointing in elevation.....	114-123
III. Pointing in direction.....	124-137

SECTION I

GENERAL

■ 110. DEFINITION OF POINTING.—The operations of the range section culminate in the determination of the range (or elevation) and the deflection (or azimuth) at which the pointing instruments on a gun must be set for firing at a particular instant. The data so determined pertain to the setting of the axis of the bore of the gun in elevation and in direction; that is, setting it at the proper vertical angle and at the proper horizontal angle. This setting operation is called “pointing.”

■ 111. METHOD OF POINTING IN ELEVATION.—The method of pointing in elevation used by seacoast artillery is the one discussed and illustrated in paragraph 20, in which the axis of the bore is given a definite elevation above the horizontal. The setting is called the “quadrant elevation.” The pointing equipment used is either the range disk, the elevation quadrant, or the data transmission system elevation receiver.

■ 112. METHODS OF POINTING IN DIRECTION.—There are two general methods of pointing in direction. In one method the target is used as an aiming point, and the axis of the bore is caused to diverge from the line of sight by an angular amount called the “deflection.” The gun is pointed by a telescope. In the other method, the axis of the bore is pointed in azimuth. There are two methods of pointing the bore in azimuth—by a telescope and a fixed aiming point other than the target and by an azimuth circle or an azimuth indicator. Both methods of pointing in direction are discussed and illustrated in paragraph 20.

■ 113. CASES OF POINTING.—There are three cases of pointing which are defined according to the combination of pointing methods used. (See app. I.)

SECTION II

POINTING IN ELEVATION

■ 114. REQUIREMENTS.—In order that the axis of the bore of a gun may be pointed correctly in elevation, the pointing equipment must indicate the true vertical angle at which the axis of the bore is elevated above the horizontal. This condition requires not only that the mechanism indicate correct angles, but also that the angles indicated be vertical angles. The first requirement may be satisfied by providing the pointing equipment with a longitudinal level or by adjusting the mechanism with the aid of a clinometer and a clinometer rest. Elevation quadrants should indicate the quadrant angle of elevation at which the axis of the bore is pointed; range disks should indicate the range, corrected for height of site, that corresponds to the quadrant elevation at which the axis of the bore is pointed. The second requirement may be satisfied by leveling the trunnions of the gun or by equipping the mount of the pointing mechanism with means for measuring vertical angles. (See TM 4-210.) This device will be referred to as a cross level in the discussion which follows.

NOTE.—All new elevation equipment will employ the mil unit, but existing elevation apparatus using yards or degrees and hundredths will be retained in service. Use of the mil unit will facilitate use of electric data transmission systems for seacoast artillery.

■ 115. LEVEL OF TRUNNIONS.—If the axis of the trunnions of a gun is not level, the axis of the bore will depart from the vertical plane as the gun is elevated. This will affect the pointing in both direction and elevation. If it were necessary to level the trunnions of mobile mounts precisely every time they were emplaced, their mobility would be greatly impaired. Therefore, the telescope mounts of mobile artillery are furnished with cross levels. Fixed guns are permanently emplaced and, if the base rings are maintained at level, do not need such a device. The level of the base ring is checked periodically and the errors in level are recorded. Correction for the effect of these errors on the range is accomplished with the aid of a clinometer and a clinometer rest, as explained in other paragraphs of this section. (See FM 4-10 for more complete discussion.)

■ 116. CLINOMETER AND CLINOMETER REST.—*a.* The clinometer is an instrument designed for the precise measurement of vertical angles. It is equipped with a cross level. The clinometer rest consists of a plug which fits tightly into the muzzle of the gun, leaving a projecting axis that coincides with the axis of the bore. The clinometer is mounted on the projecting axis. Before a clinometer is used, it should be checked for adjustment. Set the clinometer at zero and place it and the clinometer rest in position on the gun. Center the cross level bubble and elevate or depress the gun until the bubble of the longitudinal level is centered. *Check and recenter both bubbles.* Reverse the clinometer on its rest and recenter the cross level bubble; if the longitudinal bubble does not remain centered, the instrument is out of adjustment. If no other clinometer is available, the amount of the error should be determined and proper corrections should be applied to all readings and settings. When the clinometer is used, it should always be protected from the wind and sheltered from the direct rays of the sun.

b. The clinometer M1912 (see fig. 89) is graduated in degrees from -5° to $+75^{\circ}$ in intervals of 20 minutes. A vernier, provided with a magnifier for easy reading, gives readings accurate to within 1 minute. The slow motion screw is used for the fine adjustment.

c. For best results, the clinometer should be used when the temperature of the gun is uniform throughout its length. This condition is most likely to be realized in the hours just before sunrise. The rays of the sun beating on top of the gun will cause the muzzle to droop because of expansion of the metal. The amount of this droop will vary from time to time; therefore, the guns should be clinometered early in the morning or before daybreak.

■ 117. CHECK OF LEVEL OF BASE RING ON FIXED GUNS.—*a.* *Check of level.*—When the pointing equipment of the gun is not equipped with longitudinal and cross levels, which is characteristic of all fixed seacoast artillery, the level of the base ring should be checked periodically. Under conditions of alert, this should be done at least once a month and after each period of firing. A check should also be made just prior to target practice. The check may be made as follows:

(1) Set the gun at any convenient elevation and place the clinometer and the clinometer rest in position on the gun.

(2) Traverse the gun to one edge of the field of fire, center the cross level bubble, and change the clinometer setting until the longitudinal bubble is centered. Check and recenter both bubbles. Read and record the clinometer setting and the azimuth.

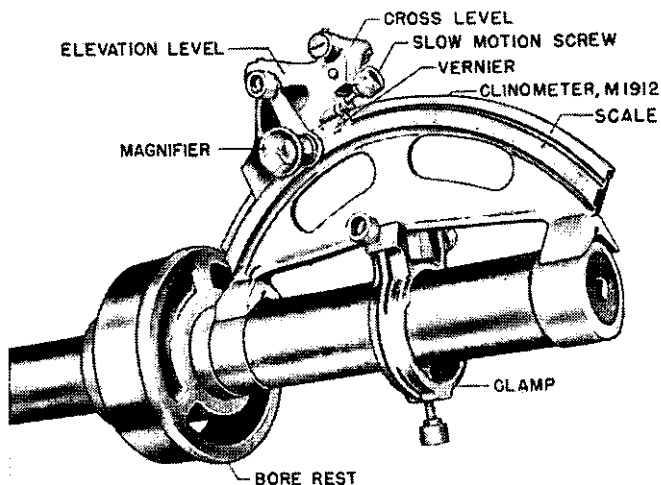

FIGURE 89.—Clinometer M1912 on clinometer rest.

(3) Without changing the elevation of the gun, traverse it 10° (or 15°) toward the center of the field of fire. Cross level and center the longitudinal bubble by changing the setting of the clinometer. Read and record the clinometer setting and the azimuth.

(4) Repeat the procedure for each 10° (or 15°) throughout the field of fire.

(5) Examine the record and select an azimuth at which to adjust the range disk for zero correction. The selected azimuth should be such that the corrections to be applied at other azimuths will be at a minimum. Compute the cor-

rections in angular units for the other azimuths. It may be helpful to plot the clinometer readings vertically against azimuth readings horizontally and connect the plotted points with a smooth curve. If a horizontal line is drawn averaging the curve, the points where the line intersects the curve will give the azimuth at which the range disk should be adjusted to zero error.

(6) The range disk is then adjusted at that azimuth, as described in paragraph 118b.

b. Corrections at azimuths other than azimuth selected for adjustment of range disk.—(1) *General.*—In most cases, if the range disk is adjusted at the azimuth selected as above, the error at the other azimuths may be neglected. However, it is advisable to compute the corrections at the other azimuths to determine whether they should be neglected. Where the corrections are too large to be ignored, they are applied as follows:

(2) *Application.*—(a) *Gun set in elevation by angular units.*—When the gun is set in elevation by means of an elevation quadrant or indicator graduated in angular units, the angular correction for any particular azimuth will be the same regardless of the quadrant elevation of the gun.

(b) *Gun set in elevation by range disk.*—If a range disk is used to point the gun in elevation, the angular corrections must first be converted into yards before they can be applied to the firing data. The change in range corresponding to a small change in elevation varies with the quadrant elevation; therefore, the correction, converted to range, will not be constant for all values of the quadrant elevation. At shorter ranges, the correction to range is larger than at the longer ranges. Therefore, it will be seen that if it is desired to use a flat correction, a decision must be made as to the range for which the correction will be computed. This will depend on the conditions involved, such as the size of angular correction, variations in size of range correction, and the limiting ranges of the armament. Usually a mean of the corrections applicable at the limiting ranges will be sufficiently accurate. The corrections may be combined with those for gun difference and the resultant correction displayed on the loading platform. (See par. 118 c.)

Example: A battery of 12-inch seacoast guns M1895 on 12-inch barbette carriage M1917, firing a 975-pound projectile (Firing Tables 12-F-3) is emplaced with a field of fire from 130° to 210° in azimuth and from 12,000 to 25,000 yards in range. During the preparation for a target practice, the emplacement officer checks the level of the base rings of the guns by means of a clinometer set initially at 10 minutes of elevation. The results of the check are as follows:

Azimuth	No. 1	No. 2	Azimuth	No. 1	No. 2
°	'	'	°	'	'
130	10	10	175	4	10
145	8	10	190	4	8
160	6	10	210	6	6

First requirement: The azimuths at which the range disks should be adjusted for zero correction.

Second requirement: The base ring corrections at other azimuths for each gun, in both elevation and range.

Solution, first requirement.

No. 1—160° azimuth.

No. 2—Any azimuth between 130° and 175°.

Solution, second requirement: The base ring corrections in minutes of elevation may be computed from the data recorded during the check of level. These corrections are tabulated below. The next step is to extract the necessary data from Firing Tables 12-F-3, by which the angular corrections may be converted into linear corrections. These data are as follows:

Range (yards)	Change in range for 1 minute change in elevation (yards)
12,000	18.6
25,000	9.2

The base ring corrections in yards may now be computed by multiplying the mean change in yards for a 1-minute change in elevation by the correction in minutes. The product is taken to the nearest 10 yards.

Azimuth	No. 1		No. 2	
	Angular correction	Linear correction (yards)	Angular correction	Linear correction (yards)
0	/		/	
130	-4	-60	None	None
145	-2	-30	None	None
160	None	None	None	None
175	+2	+30	None	None
180	+2	+30	+2	+30
210	None	None	+4	+60

NOTE.—The errors in the level of this base ring are excessive.

■ 118. RANGE DISKS.—*a. Description.*—(1) The range disk furnishes a means of pointing a gun in elevation by the use of ranges directly, thus eliminating the necessity for converting ranges into quadrant elevations. The device consists of a graduated disk connected mechanically to the elevating mechanism by gears and shafts so that it turns as the quadrant elevation of the gun is varied. The range setting is indicated opposite a fixed index on the mount. Means are usually provided for making small adjustments of the mechanism by moving either the range disk or the index. Range disks are equipped with neither longitudinal nor cross levels and include no other means for insuring the setting of vertical angles.

(2) Range disks are graduated not only for the particular combination of gun, powder charge, and projectile but also for a particular height above the target at mean low water. The data for the graduations are compiled in elevation tables which give the range elevation relation of the combination corrected for the height of site. The range disk is mounted on the gun and the gun is pointed at known angles of quadrant elevation. The corresponding ranges are then marked on the range disk opposite the index.

b. Adjustment.—An error in the adjustment of the range disk may be due to several causes. The two most common causes of error are: first, an error in the level of the base ring; second, an error due to slippage somewhere in the mechanical system between the bore and the range disk. The effect of either one or both of these causes would be the introduction of a constant angular error in elevation at a particular azimuth. This constant angular error would result in a discrepancy in range that will decrease as the quadrant elevation is increased. The adjustment is made as follows:

(1) Traverse the gun to the azimuth selected for the range disk adjustment when checking the level of the base ring. (See par. 117.)

(2) Select an elevation near the minimum limit of the gun, set the clinometer at that elevation, and place it in position on the clinometer rest. Cross level the clinometer and elevate or depress the gun until the longitudinal bubble is centered. Check and recenter both bubbles. In order to eliminate the effect of backlash, the last motion of the gun should always be made in depression with the gun loaded.

(3) Note the discrepancy between the indicated range and the range as given in the elevation tables for the elevation set on the clinometer.

(4) Repeat the procedure for an elevation at midrange and one near the maximum limit of the gun.

(5) Examine the results of the check and determine the amount of the desired range correction at the elevations tested.

(6) At any convenient elevation, set the range disk (or index) to read the correct range as indicated in the elevation tables. The resultant correction should be good throughout the limits of elevation. It should be noted that in moving the range disk or index, a flat, angular correction is made.

(7) If the error found is irregular and the cause cannot be determined, the correction should be chosen to meet the particular situation.

c. Operation.—The range setter elevates or depresses the gun until the firing range as received from the plotting room is indicated on the range disk. The last motion of the gun

should be in depression. If corrections for displacement and base ring level are to be made at the emplacement, he sets the firing range corrected by the amount of those corrections.

Example: A battery is equipped with 12-inch seacoast guns M1895 on barbette carriage M1917, firing a 975-pound projectile (Firing Tables 12-F-3). It is desired to check and adjust the range disks at an azimuth of 160°. The range disks are checked with the guns at the elevations given in the elevation tables for the ranges shown in the following table:

Range (yards)	Quadrant elevation	
	°	'
12,000.....	8	21
18,000.....	14	36
25,000.....	24	54

The following data were recorded:

Elevation set on clinometer		Range reading on disk (yards)	
		No. 1	No. 2
°	'		
8	21	12,040	12,000
14	36	18,030	18,000
24	54	25,020	25,000

First requirement: Conclusions drawn as a result of the check of the range disks.

Second requirement: Action recommended to correct errors.

Solution, first requirement: The range disk on No. 1 gun is in error by approximately 2 minutes of elevation; the gun would be pointed too low. The range disk on No. 2 gun is in adjustment.

Solution, second requirement: The range disk on No. 1 gun should be adjusted by making it read the range correspond-

ing to the angle of elevation of the axis of the bore. The adjustment may be made at any convenient elevation. The check should be repeated at two other elevations after the adjustment has been made.

■ 119. ELEVATION QUADRANT M1917 (fig. 90).—*a. Description.*—The elevation quadrant M1917 is for use with railway

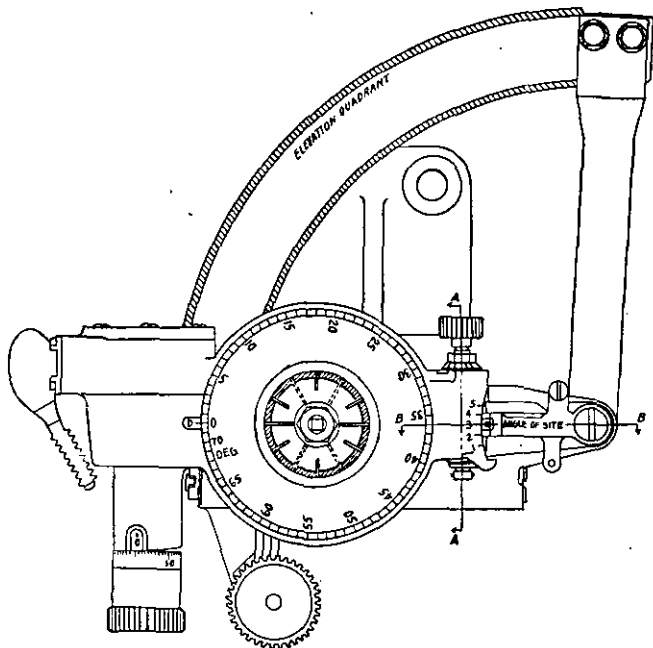

FIGURE 90.—Elevation quadrant M1917.

artillery and with guns mounted on modern barbette carriages. It is equipped with a cross level. The quadrant is attached by a fulcrum to a rocker. A tapered shank on the rocker fits in a groove in a support on the right trunnion of the gun. The purpose of this arrangement is to permit cross leveling through movement of the quadrant about a longitudinal axis parallel to the bore. The elevating,

arc bears on its outer edge a worm rack that engages a worm fastened to the quadrant arm. The arm is set in elevation by rotating the worm by means of the micrometer screw at its lower end. For fast motion, the worm may be disengaged by lifting the throw-out lever. Degrees of elevation are indicated on the elevation disk, which is geared to the inner edge of the elevating arc through a shaft and two friction disks. Minutes of elevation are indicated on the micrometer screw. The cross level and longitudinal level are carried on the quadrant arm. The cross level bubble is centered by means of the cross level screw. An angle of site mechanism is included at the front of the quadrant arm, by which the longitudinal level may be displaced through small angles from its normal position. (See FM 4-10.)

b. Adjustment.—(1) Point the gun in direction at any azimuth. Elevate the axis of the bore to quadrant elevations corresponding to short, medium, and long ranges, and check the readings of the quadrant against clinometer readings.

(2) Examine the results of the check and determine the desired correction. If the error is not constant, the quadrant should be turned in to the ordnance officer for repair. If the error is constant, correction may be applied by unscrewing the locking nuts on the elevation disk and micrometer and setting the disk and micrometer to the desired reading. Corrections may also be applied by use of the angle of site mechanism. (See example, par. 120.)

c. Operation.—The elevation setter sets the quadrant to the firing elevation as received from the plotting room. He elevates the gun until the longitudinal bubble is centered, cross levels the quadrant, and recenters the longitudinal bubble.

■ 120. ADJUSTMENTS IN ELEVATION FOR MOBILE ARTILLERY.

Example: A battery of two 8-inch seacoast guns M1888 on railway mount M1912 is emplaced for the defense of a channel that lies between the ranges of 8,000 and 15,000 yards. The guns are equipped with M1917 elevation quadrants. The quadrants were checked for accuracy with the following results:

Approximate range (yards)	Elevation set on clinometer	Quadrant reading	
		No. 1	No. 2
	° /	° /	° /
8,100	11 00	10 57	11 05
11,500	20 00	19 57	20 01
14,800	33 00	32 57	32 56

First requirement: Conclusions drawn as a result of check.

Second requirement: Detailed explanation of any adjustments made on the quadrants to correct errors.

Solution, first requirement: The quadrant on No. 1 gun is out of adjustment by 3 minutes of elevation; the gun would be pointed too high for a given range. The quadrant on No. 2 gun is damaged and should be turned in to the ordnance officer for repair.

Solution, second requirement: The quadrant on No. 1 gun may be adjusted to read correct quadrant elevations by either of two methods as follows:

a. By displacing elevation disk and micrometer.—Loosen the locking nuts and displace the elevation disk and micrometer by the necessary amount to make them indicate the reading of the clinometer.

b. By angle of site mechanism.—Set the angle of site correction scale at $2^{\circ}57'$ (that is, $3'$ off the normal setting of 3°) and relevel the longitudinal bubble by operating the elevation micrometer screw. Check the reading of the quadrant; it should now read the same as the clinometer.

■ 121. QUADRANT SIGHT M1918A1 (fig. 91).—*a. Description.*—

(1) The quadrant sight M1918A1 is an instrument for pointing a gun in elevation. It is used on the 155-mm gun G. P. F. The quadrant sight is permanently mounted on the left trunnion of the gun in a support which permits cross leveling through movement about a longitudinal axis parallel to the bore of the gun. The cross level screw is under this support.

(2) The principal parts of the elevation indicating mechanism are the worm, worm wheel and pinion, elevation scale, sight shank, and the levels. Elevations are set by turning the

elevating worm by means of the elevating screw (or micrometer) at its rear end. This rotates the worm wheel about its axis. The angle through which the worm wheel is rotated is indicated on the elevation scale, which is engraved on a drum screwed to the worm wheel.

(3) The sight shank (or bracket) is of irregular shape. Its lower end is an arc which passes through the body of the

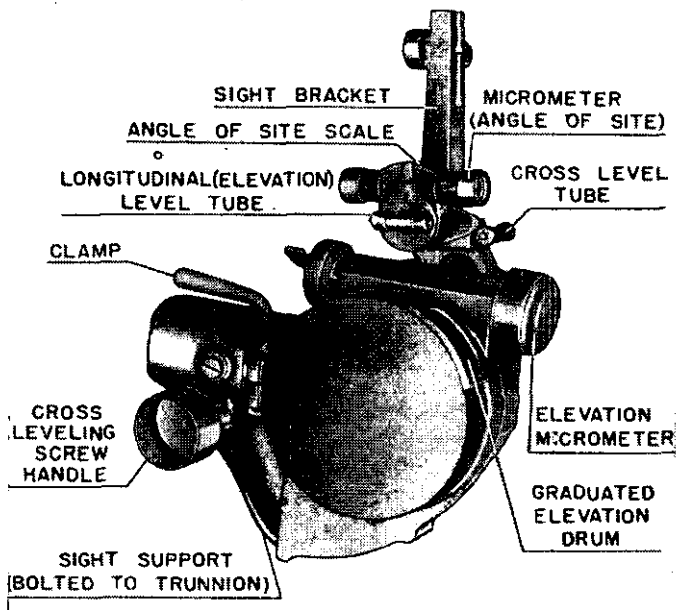

FIGURE 91.—Quadrant sight M1918A1.

sight and around the pinion on the worm wheel. A rack on its inner surface meshes with that pinion. Attached to the upper end of the arc is a straight piece which extends vertically upward and out of the body of the sight. The lower end of this vertical part carries the levels. The longitudinal level is attached to the shank through the angle of site mechanism, by which it may be displaced through small

angles from its normal position perpendicular to the sight shank.

(4) The angular displacement of the elevating worm wheel is transmitted through the pinion and rack to the sight shank, whose vertical part is displaced by a proportionate amount from the vertical. If the gun is then elevated until the longitudinal bubble is centered and the sight cross leveled, the shank will be brought back to the vertical and the axis of the bore pointed to the quadrant elevation that was set on the elevation scale. Elevations are indicated in mils.

(5) The upper end of the sight shank forms a seat for a panoramic telescope by which the gun may be pointed in direction.

b. Adjustment.—(1) Point the gun in direction at any azimuth.

(2) Elevate the gun to quadrant elevations corresponding to short, medium, and long ranges, and check the readings of the elevation scale against readings of a gunner's quadrant.

(3) Compare the readings and determine the desired correction. If the error is not constant, the quadrant sight should be turned in to the ordnance officer for repair. If the error is constant, the correction may be applied by displacing the elevation pointer or by use of the angle of site mechanism.

c. Operation.—The gun pointer sets the quadrant elevation as received from the plotting room and then keeps the cross level centered while the elevation setter elevates the gun until the longitudinal bubble is centered. The final motion of the gun should be in depression.

■ 122. GUNNER'S QUADRANT.—*a. General.*—One gunner's quadrant per gun having quadrant seats is issued to coast artillery batteries for use in checking the adjustment of elevation equipment attached to guns and carriages when a clinometer is not available or cannot be used. It may be used *in emergency* for pointing the gun in elevation. It is not provided with a cross level. Consequently, the axis of the trunnions of the cradle must be level in order to read true vertical angles by means of this instrument. There are two types in use, one having degree graduations and the other having mil graduations. Of the degree type there are two

models, M1898 and M1897; of the mil type the models are M1 and M1918.

b. Gunner's quadrant M1 (fig. 92).—This type consists of a frame and a quadrant arm (or arm sector). One portion of the frame forms an elevating arc on each side of which is an elevation scale (2), one for elevations from 0 to 800 mils, and the other for elevations from 800 to 1,600 mils. The inside edge of the arc has teeth at 10-mil intervals. The quad-

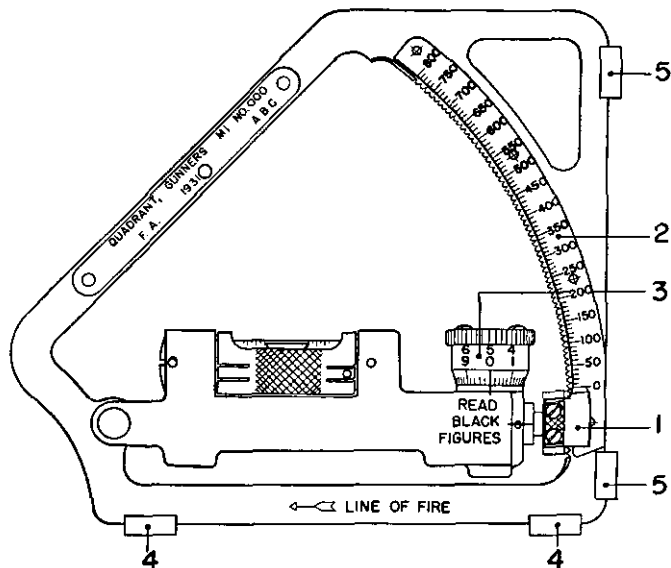

FIGURE 92.—Gunner's quadrant M1.

rant arm carries a spirit level and is pivoted at one end to the frame. The other end has a toothed sector with a ratchet device (1) which permits a rapid setting on the elevation scale at 10-mil divisions by engaging the arc at the proper elevation. Closer settings (to 0.2 mils) are made by means of the micrometer drum (3). The quadrant has two sets of leveling feet, one set (4) for use when setting elevations from 0 to 800 mils and the other set (5) for use in setting elevations above 800 mils.

*c. Older models (M1897, M1898, and M1918).—*These models, both mil type and degree type, differ from the M1 in that they have no micrometer drum. The toothed sector at the end of the arm is engaged on the arc by shortening its length against a spring, moving it to the proper elevation, and releasing it. The level is carried in a slide on the arm. The arm is slightly curved, and the closer settings are made by moving the slide and bubble along the arm to the proper graduation. (See fig. 93.)

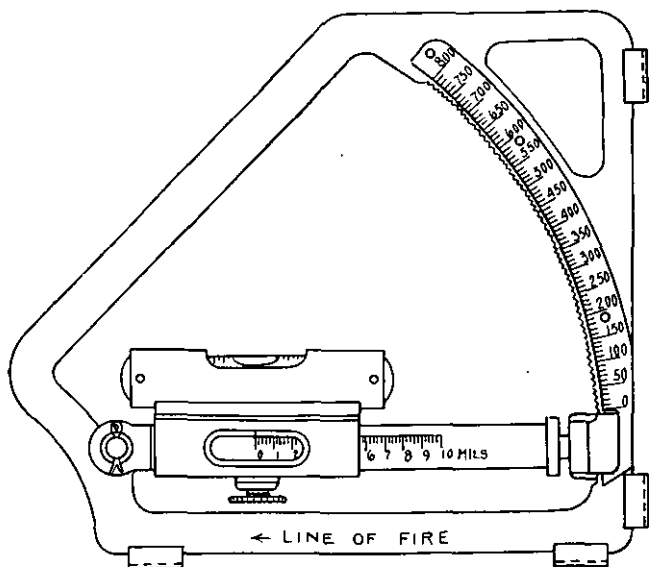

FIGURE 93.—Gunner's quadrant M1918.

d. Adjustment.—The quadrant may be checked for adjustment by comparison with an adjusted quadrant or a clinometer, or it may be checked independently (see par. 116). If found to be out of adjustment, another quadrant should be procured.

e. Operation.—Set the elevation on the quadrant, place the leveling feet squarely on the machined quadrant seats on

the breech of the gun parallel to the axis of the bore, and elevate the gun until the bubble is centered.

■ 123. ELEVATION SCALES.—Some types of barbette mounts have elevation scales graduated on the surface of the elevating arc or on a strip of metal attached to the arc. These

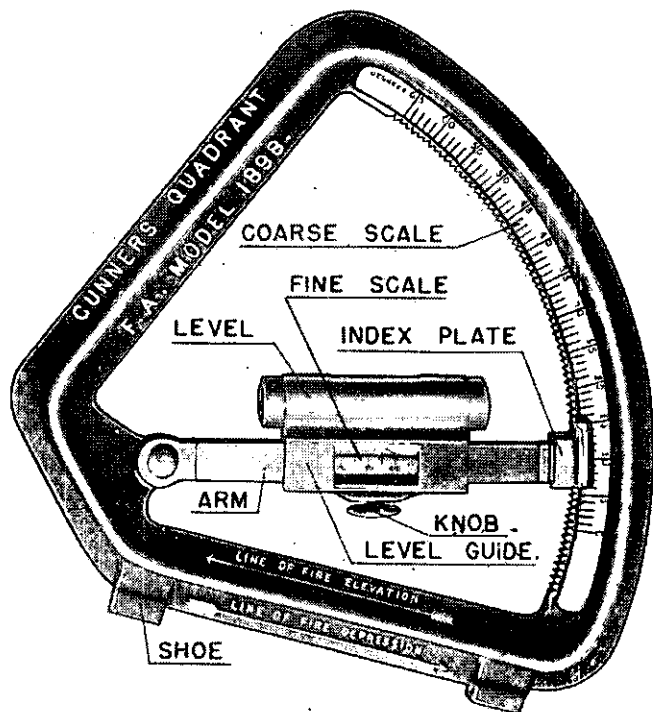

FIGURE 94.—Gunner's quadrant M1898.

scales are graduated in degrees and minutes, with a least reading of 10 minutes, and are read opposite a fixed pointer on the mount. The scales should not be used for pointing the guns except in emergencies, as they cannot be read accurately. However, they may be used to check the approxi-

mate elevation. The method of checking the adjustment of elevation scales is similar to that described for quadrants.

SECTION III

POINTING IN DIRECTION

■ 124. ACCURACY REQUIRED IN POINTING.—The accuracy with which guns should be pointed in direction is dependent on many factors, including the following: range to target, aspect of target, accuracy of firing data as received from plotting room, and pointing equipment in use. A fixed battery pointing by azimuth circle in case III, or by deflection in case II, should be able to point the guns with an accuracy of 0.01° . A mobile battery using a panoramic telescope and aiming rule should be able to attain the same accuracy as a fixed battery. If an aiming point is used, it is desirable that it be chosen so that the lateral error will not exceed either 10 yards or 0.03° , whichever happens to be the smaller error. The following table shows approximately the ranges at which the angular errors listed cause a lateral error of 10 yards:

Range (yards)	Angular error ($^\circ$)	Lateral error (yards)
19,100	0.03	10
29,600	.02	10
57,300	.01	10

The battery commander, however, should not be satisfied with an error of 0.03° if it is possible to reduce the error. Since case II firing will not ordinarily be used at ranges greater than 19,100 yards, an error of 0.03° would not be too serious in case II firing except for very small targets. A check should be made to see whether the over-all error due to sight displacement and gun displacement exceeds the allowable amount.

■ 125. LEVEL OF TRUNNIONS.—The conditions essential to correct lateral pointing depend on the method of pointing used

except that the pointing equipment must indicate horizontal angles. Horizontal angles are assured by the same methods as are used for pointing in elevation; that is, leveling the base ring on fixed mounts and providing a cross level on mobile mounts. The effect on the lateral pointing of *small* errors in the level of the base ring of fixed mounts is ignored. (See FM 4-10.)

■ 126. CASE I AND CASE II ADJUSTMENT.—In case I and in case II pointing, guns are pointed in direction by means of a telescope (pars. 129 and 131), with corrections applied by a deflection setting. In order that the axis of the bore may be set at the required horizontal angle with the line of sight, the proper relation must first be established between the axis of the bore and the normal position of the line of sight; that is, its position when the deflection setting is normal. Since the telescope is not mounted in the same vertical plane as the axis of the bore, the normal line of sight and the axis of the bore cannot be made to coincide, but they can be made parallel or they can be made to intersect at any desired distance from the gun. The process by which the axis of the bore and the normal line of sight are made parallel or are made to converge on a point is called "boresighting." Once this relationship has been established, the setting of any deflection other than normal will cause the line of sight to be moved from its normal position through an angle equal to the difference between the actual deflection set and the normal setting. If the gun is then traversed until the line of sight of the telescope is directed at the target, the gun will be pointed in the desired direction.

■ 127. CASE III ADJUSTMENT.—*a. Orientation.*—When using case III methods, the gun is pointed in azimuth by the use of an azimuth circle or a panoramic telescope pointed at an aiming point other than the target. The necessary adjustment is called "orientation" and consists of directing the axis of the bore at a known azimuth and adjusting the pointing instrument or the azimuth circle to indicate that azimuth.

b. Determination of azimuth.—There are several ways in which the azimuth of the axis of the bore of a gun may be

determined. For the methods and the adjustments necessary see paragraph 134.

c. *Aiming point and aiming rule.*—Azimuth circles are placed on the mounts concentric with the pintle center (or center of rotation) of the gun and, if correctly adjusted at one azimuth, will indicate all azimuths correctly. A panoramic telescope is not so mounted but is displaced from the axis of rotation of the gun by a small distance, the exact displacement depending on the type of mount. As a consequence, there is parallax between the axis of rotation of the sight and that of the gun. If a fixed aiming point is used, this parallax introduces an error into all azimuths except that at which the orientation was made. It is desirable that guns be pointed with an accuracy sufficient to insure that the lateral error due to errors in pointing should not exceed 10 yards or 0.03° . The aiming point should be far enough away from the guns that the error caused by sight displacement will not exceed the preceding accuracy requirements. The aiming rule was devised for use when a suitable fixed aiming point could not be found. It acts as an aiming point at infinity and eliminates errors due to sight displacement. (See par. 132.)

■ 128. THEORY OF POINTING GUN BY MEANS OF DEFLECTION ANGLE SET ON TELESCOPE.—If it is assumed that a telescope is mounted above the pintle center of the gun, then the line of collimation will lie in the same vertical plane as the axis of the bore when the bore and the telescope are pointed at the same target (fig. 98A). The telescope is then turned through an angle of 2° (fig. 98B) to the left. The axis of the bore of the gun still points to the target. If the gun and telescope are now moved together until the telescope is brought back on the target, the gun will have been moved 2° to the right (fig. 98C). The telescope is equipped with a scale graduated so that the readings increase as the telescope is turned to the left, away from the axis of the bore. When the sight is turned to the left and the gun is then traversed to bring the telescope back on the target, the gun is moved to the right. From this fact, the general rule of "Right, raise—left, lower" is deduced. In actual practice, the telescope is not placed at the pintle center of the gun but is

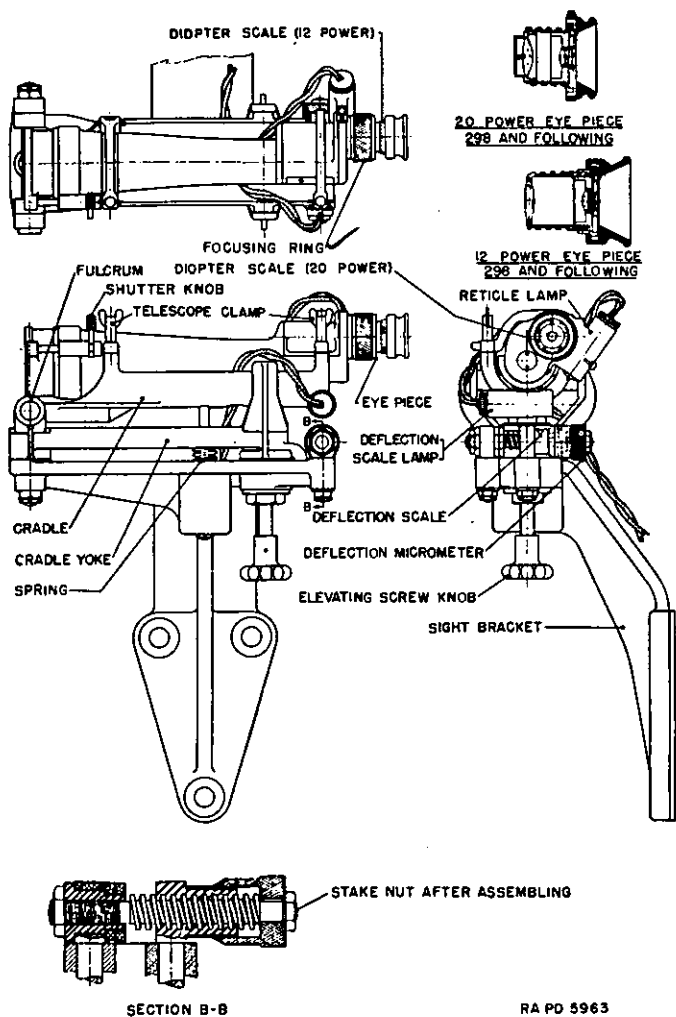
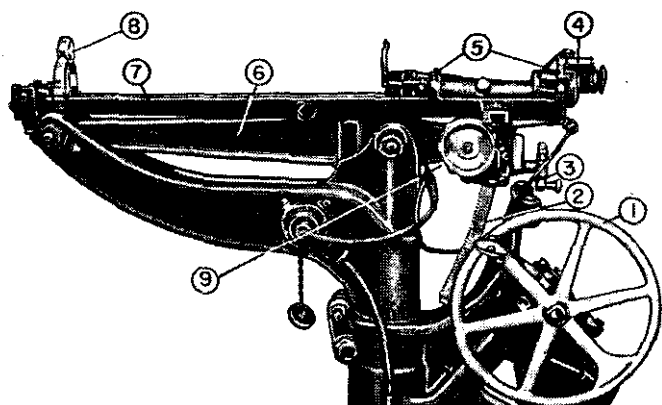

FIGURE 95.—Telescope mount M1910 and 3-inch telescope M1904MII.



- | | |
|------------------------------|----------------------|
| 1. Gun traversing handwheel. | 6. Sight arm. |
| 2. Elevation rack. | 7. Cradle. |
| 3. Elevation handwheel. | 8. Front open sight. |
| 4. Rear open sight. | 9. Range drum. |
| 5. Clamps. | |

FIGURE 96.—Telescope mount M1904M1A1 and 3-inch telescope M1904MI.

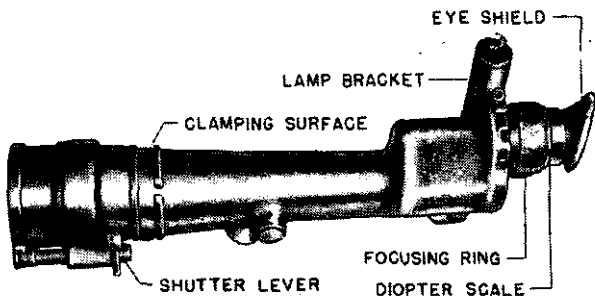

FIGURE 97.—3-inch telescope M1904MI and M1904MII.

displaced a small distance to the left. Because of this, there is a slight error due to parallax. A more complete discussion of sight displacement is given in FM 4-10.

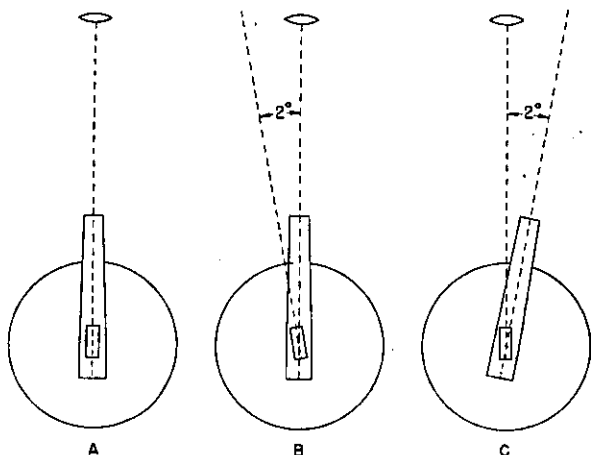

FIGURE 98.—Pointing gun by deflection angles.

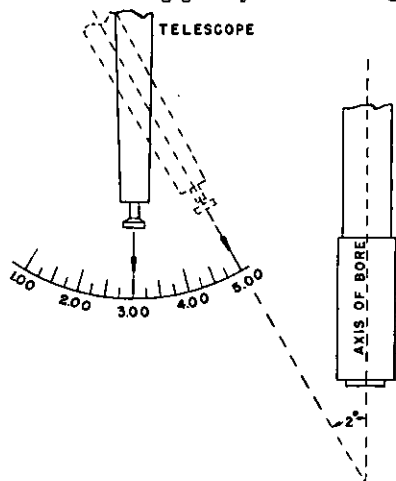

FIGURE 99.—Use of deflection scale (angular scale has been exaggerated).

■ 129. TELESCOPES USED IN POINTING.—*a. Description.*—Instruments of this type (fig. 100) are provided for all fixed seacoast artillery mounts and for 14-inch railway gun mounts except for certain batteries which are so sited as to preclude case II pointing. They are similar in design to the telescope of an azimuth instrument. (See par. 46.) The reticle contains either cross wires or some form of clover leaf design in which the target is centered. The telescopes are of varying size and magnifying power to fit the conditions under which they are used. The mounts are also similar in general principles but vary in minor details. The

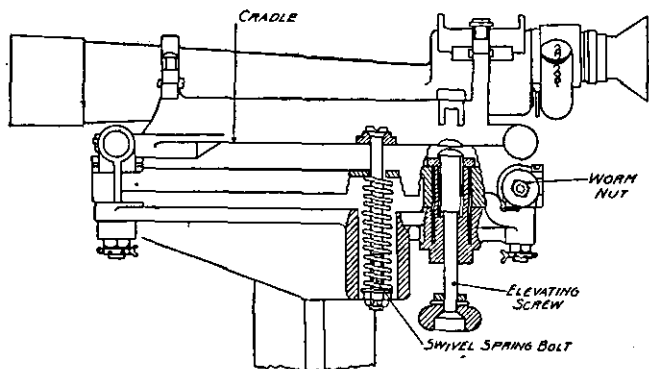

FIGURE 100.—Telescope M1912 and mount.

mount is in the form of a cradle which is attached to the carriage in such a manner as to permit vertical motion of the telescope if necessary. On some types of mounts, deflections are set by moving the telescope horizontally; on others, the sight is held fixed, and the vertical cross wire is moved from its normal position. Regardless of the method used, a deflection setting greater than normal moves the axis of the bore to the right, and a setting less than normal moves it to the left. The deflection scale is usually on the mount. It is graduated in degrees and hundredths. The normal of the scale depends on the type of mount and may be either 3.00, 6.00, or 10.00. The telescope mounts on railway artil-

lery are designed to permit longitudinal and cross leveling. (See TM 4-210.)

b. *Telescope M31 on telescope mount M35.*—A typical telescope is the M31 on telescope mount M35, which is standard for the 6-inch barbette carriage M1, 8-inch barbette carriage M1, and the 16-inch barbette carriage M4. The telescope is similar to those used on azimuth instruments. It has a fixed focus objective lens and eight-power magnification. The eyepiece is adjustable to different operators and has a diopter scale to enable the observer to prefocus the telescope if he knows his own correction. A selection of filters is provided.

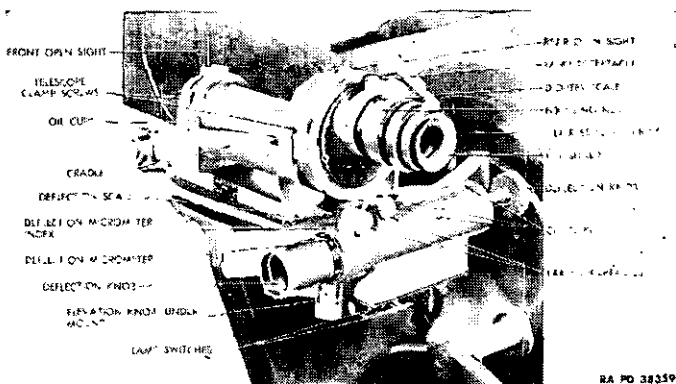

FIGURE 101.—Telescope M31 on telescope mount M35.

The telescope is clamped in the cradle of the telescope mount M35, which is equipped with open sights parallel to the telescope line of sight. (See fig. 101.) The elevation knob under the mount is used to elevate or depress the cradle and telescope. The deflection knob is used to swing the cradle and telescope through a small horizontal angle. The size of this horizontal angle is indicated by the deflection scale and the deflection micrometer. The deflection scale is calibrated from 0° to 20° at 1° intervals, 10° being normal. The deflection micrometer is calibrated in hundredths of degrees. Provision is made to illuminate the deflection scale, the micrometer, and the reticle. The adjustment of the deflection scale

and micrometer is checked by boresighting, as described in c below. If necessary to adjust the scale, loosen the screws at each end of the scale, shift the scale to bring the 10° graduation into coincidence with the index, and tighten the screws. To adjust the micrometer, loosen the three screws in the cupped end of the deflection knob, turn the micrometer to the zero reading, and tighten the screws.

c. Adjustment.—These instruments are used only for case I and case II pointing. Therefore, the only adjustment necessary consists of boresighting. The proper adjustment for all conditions of firing is that in which the axis of the bore is made parallel to the line of sight with normal deflection setting. However, since the displacement of the telescope is never more than 1.5 yards, the error introduced by adjusting on a point not at infinity will be negligible if the range used is sufficiently great. Furthermore, guns using these telescopes are usually so emplaced that there are suitable datum points in the field of fire on which the gun may be boresighted. Hence, the usual adjustment is that of boresighting on a point not at infinity. The procedure is as follows: Select a datum point at suitable range; that is, beyond the mean tactical range of the gun. Place a boresight in the breech of the gun and a thread along the vertical diameter of the muzzle. Direct the gun at the datum point by sighting along the axis of the bore. Adjust the deflection mechanism so that the deflection scale indicates normal with the telescope pointed at the datum point. On some types of instrument this may be done by directing the telescope at the datum point and adjusting the deflection scale to read "normal." On others, no adjustment can be made on the scale, but the telescope may be moved on its standard after loosening the setscrews. On the latter type, the adjustment is made by setting the deflection scale at normal and moving the telescope on its standard until the line of sight passes through the datum point.

Example: The vertical axis of the telescope on an 8-inch seacoast gun MK. VI Mod. 3A2, on barbette carriage M1, is approximately 1.2 yards to the left of the axis of the bore. The telescope is adjusted by boresighting for convergence on a datum point 6,000 yards from the gun.

Required: The amount of the angular error introduced into the pointing.

Solution: The angular error introduced into the pointing corresponds to the angle f in figure 102.

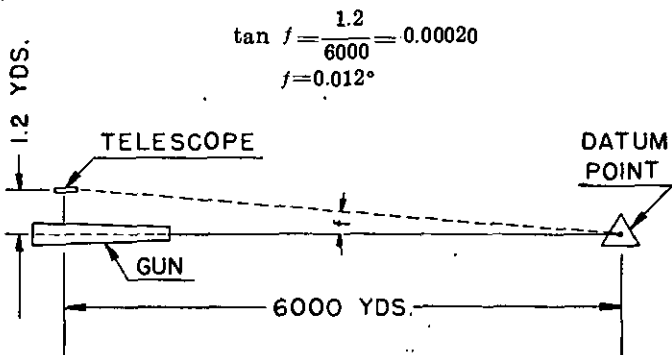
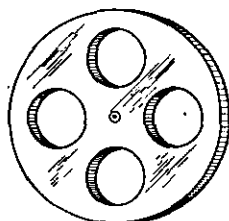

FIGURE 102.—Problem in parallax.

NOTE.—The primer vent in the breechblock may be used in place of the boresight. The vertical thread is attached to the muzzle as before and is lined up on the datum point by sighting through the primer vent.

■ 130. **BORESIGHTS.**—The boresight is used to indicate the direction of the axis of the bore of the piece for orientation purposes. Each boresight is composed of a breech element and a muzzle element.

a. Description.—(1) The breech sight may be a disk (fig. 103) or a segment of a disk (fig. 104) which fits accurately in the breech chamber of the gun. The model of the piece for which it is to be used is engraved on the disk or segment.



RA FSD
498

FIGURE 103.—Boresight, disk type.

(2) There are two types of muzzle boresights.

(a) One type of muzzle boresight includes a quantity of black linen thread to be stretched tightly across the muzzle vertically and horizontally in the score marks on the muzzle and a web belt to be buckled around the muzzle to hold the thread in place.

(b) The other type of muzzle boresight (used on the 155-mm M1 gun) is similar to the disk type of rear sight except that in place of the peep hole it has a specially cut opening used in sighting. (See TM 9-350.)

b. *Operation.*—With the two elements in place, look through the aperture in the breech boresight. The direction of the axis is indicated by the thread intersection.



FIGURE 104.—Boresight, segment type.

c. *Care and preservation.*—Handle the metal boresights carefully to prevent nicks and burs. If the muzzle boresight consists of a thread and web belt, wind it into a compact bundle when not in use.

■ 131. PANORAMIC TELESCOPES (figs. 105, 106, and 107).—*a. Description, general.*—(1) Panoramic telescopes are provided for all mobile seacoast artillery mounts for use in case II or case III pointing. They are of varying sizes and magnifying powers but are similar in construction and in principles of operation. The telescope consists of a fixed elbow and a rotating head. An attachment on the back of the elbow fits in the telescope mount on the gun carriage. The elbow contains the eyepiece and objective and has a reticle with horizontal and vertical cross wires. Other optical elements are also included in the telescope which permit movement of the rotating head to change the direction of the line of sight without disturbing the line of collimation. The head may also be moved through a few degrees of elevation on both sides of the horizontal.

(2) The head is attached to and supported by a movable

limb which is housed in the upper part of the elbow. An azimuth scale is carried on the limb. The smallest reading on the azimuth scale depends on the model of the telescope and may be 1°, 10°, or 100 mils. Smaller readings are marked on the azimuth micrometer which is fastened to a handwheel geared to the movable limb. Indexes fixed to the housing are provided for the azimuth scale and the micrometer. The head may be rotated by either turning the azimuth handwheel or by disengaging the handwheel by means of a throw-out lever and turning the head. Azimuth readings increase as the head is turned counterclockwise; that is, as the line of sight is turned to the left. (See note below.) On the movable limb, the diameter which coincides with the line of sight is indicated by a reference mark. When this reference mark is opposite the fixed azimuth index on the housing, the line of sight is parallel to the axis of the bore.

(3) Both the azimuth scale and the micrometer are so attached to the telescope that they may be adjusted to read any desired azimuth for any position of the line of sight.

(4) All mounts for panoramic telescopes, being on mobile armament, are provided with means for longitudinal leveling and cross leveling.

(5) A list of panoramic telescopes suitable for use with sea-coast artillery follows:

Designation		Gun mounts	Graduations on scales
New (panoramic telescope)	Old (panoramic sight)		
M2A1.....	M1917MIIA2.....	155-mm G. P. F.....	Mils.
M3A1.....	M1917MIIA1A3.....	155-mm G. P. F.....	Degrees.
M4.....	M1917MIIA4.....	155-mm G. P. F.....	Mils.
M1917MI.....	M1917MI.....	14-inch gun, railway mount, M1920.	Do.
M1918MII.....	M1918MII.....	Railway.....	Degrees.
M1922.....	M1922.....	Railway.....	Do.
M8.....	None.....	155-mm and 8-inch railway M1.	Do.

NOTE.—Several other models of the panoramic telescope are similar in appearance to some of those listed but are graduated in the reverse direction and should not be used for sea-coast artillery firing unless unavoidable. Telescopes should be examined to verify whether or not they are suitable for such use. See paragraph 136 and Appendix IX for detailed information on these sights.

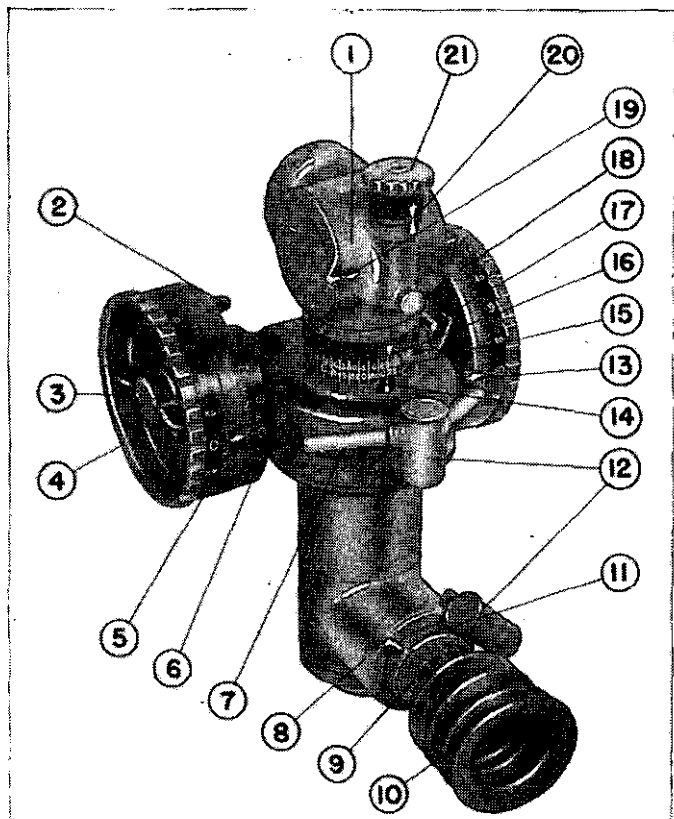

- | | |
|--|--|
| 1. Rotating head assembly. | 11. Reticle illuminating window cover. |
| 2. Lever (moves azimuth micrometer index). | 12. Lamp brackets. |
| 3. Wing nut (clamps azimuth micrometer). | 13. Deflection micrometer index. |
| 4. Azimuth micrometer. | 14. Lower index. |
| 5. Azimuth micrometer index. | 15. Azimuth scale. |
| 6. Lateral correction scale. | 16. Upper index. |
| 7. Azimuth worm assembly. | 17. Clamping screw (clamps azimuth scale). |
| 8. Elbow telescope assembly. | 18. Deflection micrometer. |
| 9. Diopter scale. | 19. Elevation index (coarse). |
| 10. Eyeshield. | 20. Elevation index (fine). |
| | 21. Elevation knob. |

FIGURE 105.—Panoramic telescope M8.

b. Panoramic telescope M8 (formerly T2).—(1) *Description.*—(a) This telescope has been adopted as standard for 155-mm guns used by the Coast Artillery Corps and for the 8-inch railway gun mount M1A1 and will be treated in greater detail than the others. It is similar to older panoramic telescopes but is somewhat larger. It has improved mechanical features and a six-power optical system. It is an all-purpose telescope and can be used for case II and case III firing. Examination of figure 105 will show the

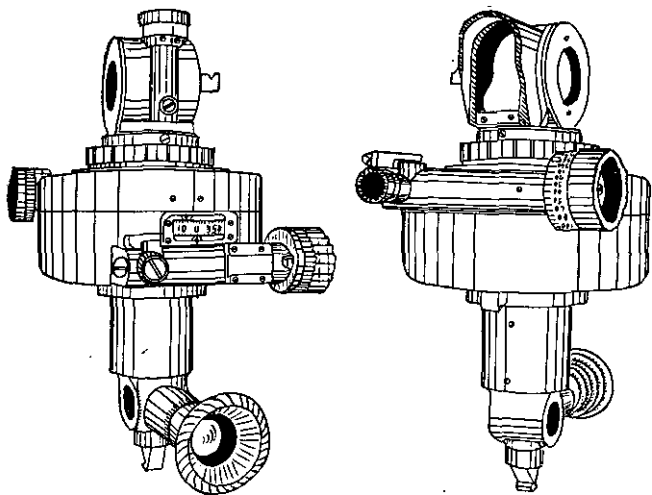

FIGURE 106.—Panoramic telescope M1922.

arrangement of the various scales. Graduations in degrees and hundredths are used:

(b) This telescope (fig. 105) consists of the rotating head assembly (1), the azimuth worm assembly (7), and the elbow telescope assembly (8). The rotating head assembly contains a prism which can be rotated about the horizontal axis a limited amount by means of the elevation knob (21). When the index (20) on this knob matches the corresponding index on the assembly, and the elevation indexes (19) are matched, the line of sight of the telescope is perpen-

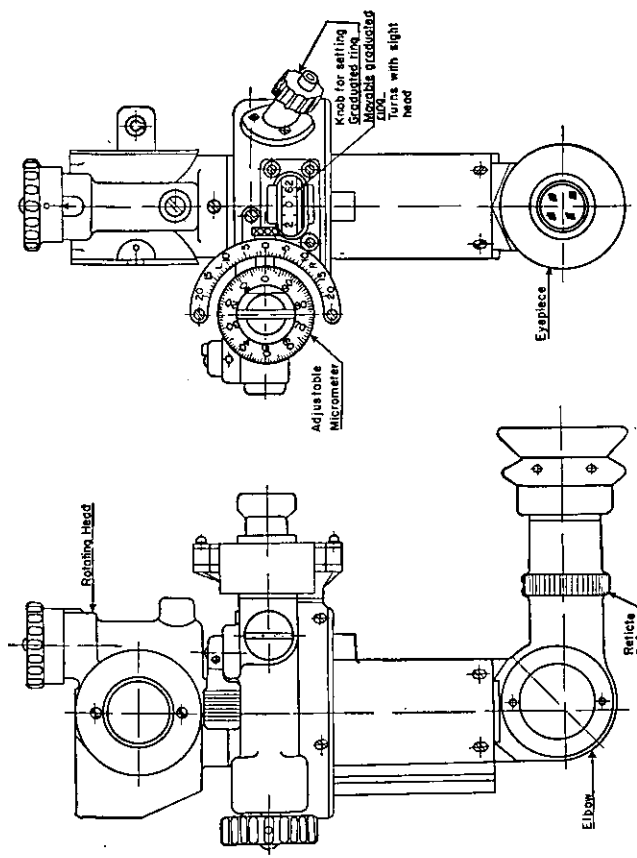

FIGURE 107.—Panoramic telescope M2A1.

dicular to the vertical axis. The azimuth scale (15), graduated every 10° from 0° to 360° , is free to rotate around the vertical shank when the clamping screw (17) is loosened and is held firmly to the shank when the clamping screw is tightened. The two knobs on either side of the telescope are keyed to a shaft which operates a worm gear to turn the rotating head. The gearing is such that one rotation of the knobs causes the rotating head to move through an angle of 10° . Each knob is provided with a micrometer scale. The one on the left (4) is graduated from 0° to 10° ; the one on the right is graduated from 5° to 15° with 10° as the normal. The smallest graduation on either scale is 0.05° .

(c) The azimuth micrometer scale (4) can be released by turning the nut (3) 90° counterclockwise, and can then be slipped to any position. Turning the nut in a clockwise direction will then lock the scale to the knob. The index (5) to this scale is moved by means of the lever (2), and the amount of its movement is measured on the lateral correction scale (6). This index is set by slipping a ratchet, and as a result, the index can be moved only in multiples of 0.05° . If the knob on the left is pushed forward, the azimuth worm gear is disengaged, and the head can be rotated in either direction by hand.

(d) The deflection micrometer scale can be released by loosening the four screws on the outside face of the right-hand knob and slipping the scale around until the desired reading appears opposite the index. The scale is clamped in the new position by tightening the screws.

(e) The eyepiece is furnished with a diopter scale (9), having a normal of 0 and graduated from -3 to $+3$, and is focused on the reticle by turning in either direction. Two lamp brackets (12) are provided to furnish illumination of the azimuth scales, the micrometers, and the cross wires in the reticle. To control illumination of the latter an adjustable cover (11) is provided.

(2) *Adjustment.*—(a) *Case II.*—The adjustment of any panoramic telescope consists of boresighting and is theoretically the same as that for the telescopes described in the preceding paragraph.

1. If the gun is emplaced so that it may be boresighted on a point at a suitable range (that is, if the range to the point is such that the angle of convergence is less than $\frac{1}{2}$ mil or 0.03° —see example par. 129c), the adjustment may be made to secure convergence as described in paragraph 129c. This is the normal method of adjustment.
2. If the guns are emplaced where no suitable point is visible, adjustment is made to secure parallelism, using a testing target. (A testing target is a chart constructed for the particular combination of gun and sighting equipment.) For 155-mm guns such a target is provided by the Ordnance Department. Suitable targets may be constructed for other guns. (See fig. 108.)

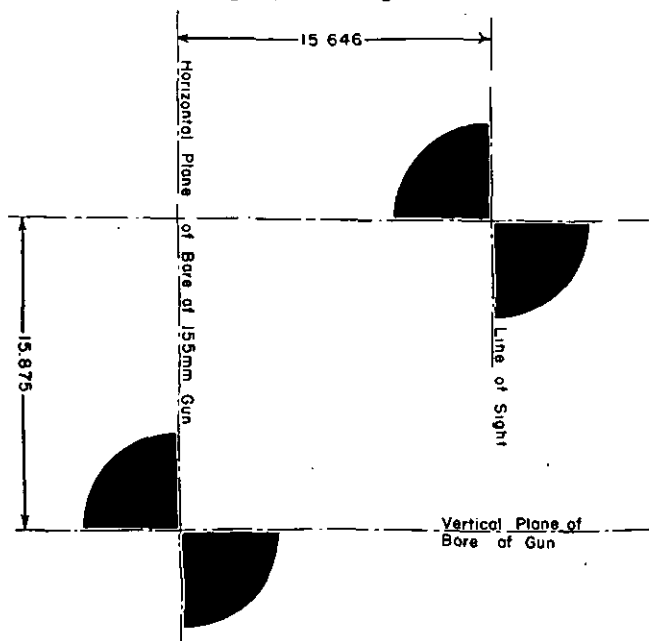

FIGURE 108.—Testing target for 155-mm gun G. P. F. equipped with quadrant sight M1918A1.

3. Adjustment to secure parallelism also may be made by use of a transit. Set the transit up at some convenient point in front of the gun. Direct the transit and the gun at each other so that the axis of the bore coincides with the line of sight of the transit. Turn the telescope head until it points at the transit. Measure the angle f with the transit, being careful to sight on the vertical axis of the panoramic telescope. Angle f' , the angle through which the head must be rotated to make it parallel to the bore, is equal to angle f . Subtract the angle f from 10° , and with the telescope still set on the transit, slip the deflection scale until it reads this value. If the head is turned

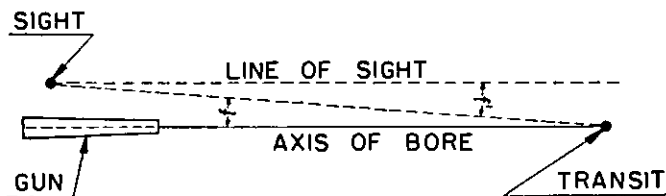

FIGURE 109.—Boresighting a gun using panoramic telescope.

away from the axis of the bore to the point where the deflection scale reads 10 and indexes (14) and (15) are together, the head will be pointing parallel to the bore. The azimuth micrometer index (5) is moved to zero correction and the azimuth micrometer (4) is slipped to read zero. If desired, the transit can be set in the rear of the gun, in which case the angle f would be added to 10° to obtain the reading to which the deflection scale should be slipped. Otherwise, the procedure is exactly the same.

4. This method of boresighting may be used for the adjustment of telescopes of the type described in paragraph 129, if the transit can be set up at a distance sufficient to accommodate the limited lateral movement of the telescope.

(b) *Case III.*—This adjustment consists of orienting the telescope to read the azimuth of the axis of the bore when the telescope is pointed at the aiming point. Having determined the azimuth of the axis of the bore, direct the telescope at the aiming point and adjust the azimuth circle and micrometer to read that azimuth. (See par. 135, examples *b* to *e*, inclusive.) Methods of determining the azimuth of the axis of the bore are discussed in paragraph 134. The adjustment of the M8 telescope for case III consists of loosening the clamping screw (17) and the wing nut (3) and slipping the azimuth scale and micrometer scales to indicate the azimuth of the bore, the rotating head being pointed at the aiming point. When this has been accomplished, the azimuth and micrometer scales are clamped by tightening the screws. This completes the orientation of the telescope for case III pointing.

NOTE.—During this adjustment the micrometer index must be set to zero on the correction scale.

(3) *Operation.*—(a) *Case II.*—The gun pointer sets the deflection received from the plotting room and tracks the target with the vertical cross wire by traversing the gun, keeping the longitudinal and cross level bubbles centered. The deflection is set on the M8 telescope by turning the micrometer knob until the desired deflection is set opposite the index (13). Precaution should be taken to see that the upper index (16) is less than 5° from the lower index (14) to avoid a deflection error of some multiple of 10° . An alternate method which permits the introduction of individual gun corrections is to set the deflection opposite the azimuth micrometer index (5), in which case zero on the scale is considered as 10 and 1, 2, 3, and 4 are considered as 11, 12, 13, and 14 respectively. Individual gun corrections can then be introduced by shifting the azimuth micrometer index (5) along the correction scale.

(b) *Case III.*—The gun pointer sets the azimuth received from the plotting room and traverses the gun until the vertical cross wire is on the aiming point with both bubbles centered. In using the M8 telescope in case III pointing, the azimuth desired is set on the azimuth scale (15) and the azimuth micrometer (4) by rotating either the knob on the

left or the right. Individual gun corrections can be applied by shifting the azimuth micrometer index (5) along the correction scale (6) the desired amount. When turning the knob on the left, special care should be taken not to displace the index by mistake. This can be avoided by using the deflection setting knob to set the proper azimuth reading on the azimuth micrometer at the azimuth micrometer index (5).

NOTE.—One of the disadvantages of this telescope is that individual corrections can be made only to the nearest 0.05° . (See par. 131b.)

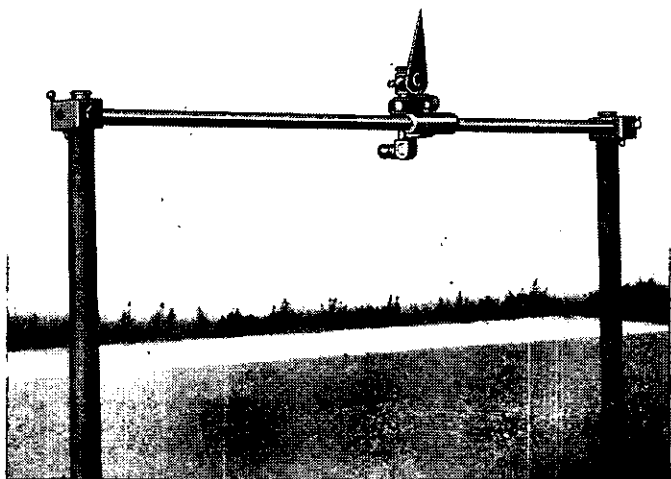

FIGURE 110.—Aiming rule with panoramic telescope.

■ 132. AIMING RULE.—*a. Description and theory.*—The aiming rule (fig. 110) is furnished to the 8-inch railway seacoast artillery for use as an aiming point. When so used it provides the equivalent of an aiming point at infinity and thereby eliminates errors in pointing due to displacement of the telescope on the gun. It consists of two upright steel stakes and a connecting bar. The bar provides a path for an adapter, which is mounted on it in such a manner that it cannot be rotated about the bar but may be slid along its length. A

panoramic telescope (or any telescope with cross wires) is mounted on the adapter. The device is so constructed that if the uprights are vertical and the cross bar horizontal, the elbow of the telescope will be maintained in a vertical position. The uprights need not be vertical and the cross bar horizontal if the adapter can be leveled by means of cross levels. The cross bar should be of a rectangular cross-

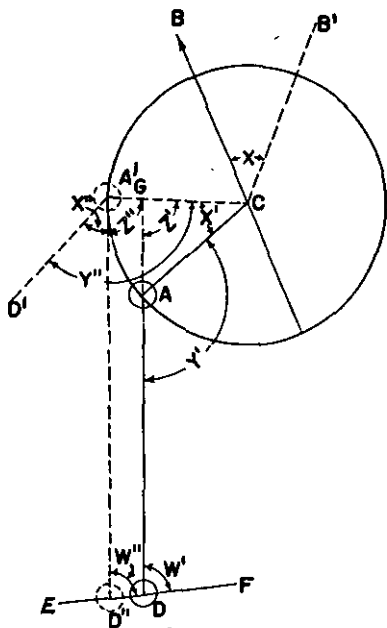

FIGURE 111.—Theory of aiming rule.

section. Figure 111 is a horizontal projection showing the geometric principles involved in the use of the aiming rule. *CB* represents the axis of the bore of the gun with *C* as the pintle center; *A* represents a panoramic telescope mounted on the gun; *AD* represents the line of sight of the telescope when oriented to read the azimuth of *CB*. The basic hypothesis is as follows: If the axis of the bore is traversed to any other azimuth, such as *CB'*, and the telescope is set to read

that azimuth, its line of sight, $A'D''$, will always be parallel to its original line of sight at orientation, AD . Let the change of azimuth be the angle X . Then the axis of the telescope will be moved through the horizontal angle X' , equal to X , since it is traversed with the gun. Furthermore, since the line of sight has not been moved with respect to the gun, the angles Y'' and Y' are equal. As stated in the hypothesis, the telescope is now set at the new azimuth of the gun; that is, the line of sight is moved through the angle X'' , equal to X or to X' .

Proof of hypothesis:

Prolong the line AD to intersect $A'C$ at the point G .

$Z'' = Y'' - X'' = Y' - X' = Z'$, and $A'D''$ is parallel to AD .

The proof holds for all values of X .

This principle is adapted to use by placing the aiming rule in the position EF and the aiming rule telescope at D . In this position the telescope D is pointed at A by rotating the line of sight. At the same time the gun telescope A is pointed at D and the azimuth scale adjusted to read the azimuth of the axis of the bore CB . The gun may now be pointed at any azimuth, such as CB' , by the following procedure: set telescope A at the desired azimuth and point both telescopes at each other, moving the line of sight of A by traversing the gun and the line of sight of D by sliding D along the aiming rule EF . Since the line of sight of telescope D has not been rotated, the angles W'' and W' are equal and $A'D''$ is parallel to AD .

b. The aiming rule may be set up at any convenient distance from the gun within visible range. The rule is not sufficiently long to allow all around fire with a single set-up. To secure the widest uninterrupted field of fire, special attention must be given to the siting of the rule. The following general directions apply:

(1) The axis of the bore of the gun should be pointed approximately at the center of the field of fire when the telescope is oriented.

(2) With the axis of the bore approximately at the center of the field of fire the aiming rule cross bar should be approximately perpendicular to the line from the gun telescope to the aiming rule telescope.

(3) The line from the aiming rule telescope to the gun telescope should be approximately perpendicular to the line from the gun telescope to the pintle center of the gun.

(4) The aiming rule telescope should be at the end of the cross bar corresponding to the position of the gun telescope on the line from the gun telescope to the pintle center of the gun.

c. Adjustment.—(1) Traverse the gun to the desired azimuth for orientation and select the position of the aiming rule according to the directions just given. Set up the aiming rule so that the elbow of the telescope will be held approximately vertical and place the aiming rule telescope in its selected position on the bar. Both telescopes must remain in these positions until the orientation is completed.

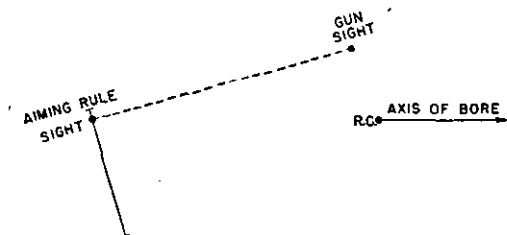

FIGURE 112.—Requirements for use of aiming rule.

The adjustment of the aiming rule telescope is completed by turning the rotating head until the line of sight passes through the gun telescope. The adjustment of the gun telescope consists of orienting it on the aiming rule telescope in the same manner as on a fixed aiming point. (See par. 135, example *e* (3).) The adjustment of the aiming rule telescope may be checked independently of the gun if the following data are recorded when making the original adjustment:

(a) The position of the aiming rule telescope on the cross bar during the original adjustment (by a mark on the cross bar).

(b) The azimuth reading of the aiming rule telescope when pointed at the gun telescope during orientation.

(c) The azimuth reading of the aiming rule telescope on a fixed reference point. This reference point should be

one visible at night as well as in daylight and should be near the line, or near the prolongation of the line, from the aiming rule telescope to the gun telescope.

(2) With these data the aiming rule telescope may be readjusted independent of the gun as long as the aiming rule remains in its original position. Reset the telescope at its original position on the cross bar and point it at the reference point. Check and, if necessary, adjust the azimuth to the reference point reading (1) (c) above. Reset the telescope to the azimuth reading used in the original adjustment, (1) (b) above.

NOTE.—Although the word "azimuth" has been used in this discussion in connection with both telescopes, the gun telescope is the only one on which actual azimuths need be set. The readings on the aiming rule telescope may be those which happen to be indicated on the azimuth scale and micrometer.

d. Operation.—The operator of the aiming rule keeps the telescope set at the azimuth used when adjusting and follows the movement of the gun telescope by sliding his telescope along the aiming rule. The operations of the gun pointer are the same as when a fixed aiming point is used. (See par. 131.)

■ 133. **AZIMUTH CIRCLES.**—*a. Description.*—Azimuth circles for case III pointing are provided on fixed seacoast guns. The circles are graduated in whole degrees and attached to the base ring of the carriage in permanent position. There are two types of indexes in common use, both arranged to show the hundredths of a degree of azimuth. One type employs a movable index which is set by means of a micrometer screw with a subscale on its head; the other type consists of a subscale fixed to the racer opposite which the whole degree graduation on the azimuth circle is set to the hundredths on the subscale.

b. Adjustment.—(1) *Orientation.*—The azimuth circle is oriented when the gun is installed, but the index or subscale is movable for minor adjustments. The adjustment on an azimuth circle consists of orienting it and the index to read the azimuth at which the axis of the bore is pointing.

Example a: A battery of two 12-inch guns on barbette carriages is emplaced with the two guns 100 yards apart. The

BC station is the midpoint on a line connecting the two guns but is not visible from either gun. An oriented azimuth instrument is mounted over the BC station. It is desired to orient the azimuth circle on the guns.

Required: An explanation of the procedure for orientation.

Solution: Set up a transit at a point visible from the BC station and both guns if possible. Determine the angle between the BC station and each gun. Assume that the

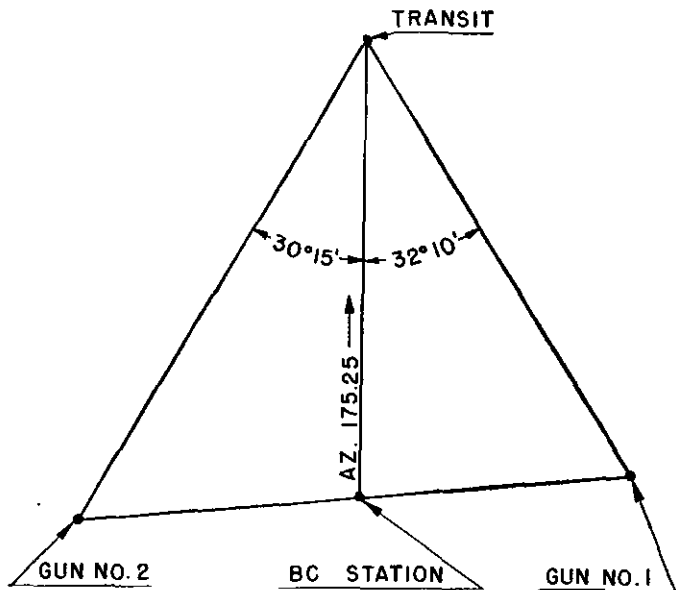

FIGURE 113.—Orientation of azimuth circles by transit (example a, par. 133).

azimuths and angles determined are as shown in figure 113. Boresight each gun on the transit. Direct the azimuth instrument on the transit and read the azimuth. From the recorded data, compute the azimuth at which the axis of the bore of each gun is pointing. The computations are as follows (transit readings have been changed to degrees and hundredths):

1. Azimuth: BC to transit....	175.25°
2. Azimuth: transit to BC...	$175.25^\circ + 180^\circ = 355.25^\circ$
3. Angle: BC to No. 1 gun....	32.17°
4. Angle: BC to No. 2 gun...	30.25°
5. Azimuth: transit to No. 1 gun.	$355.25^\circ - 32.17^\circ = 323.08^\circ$
6. Azimuth: No. 1 gun to transit.	$323.08^\circ - 180^\circ = 143.08^\circ$
7. Azimuth: transit to No. 2 gun.	$355.25^\circ + 30.25^\circ = 385.50^\circ$
8. Azimuth: No. 2 gun to transit.	$385.50^\circ - 180^\circ = 205.50^\circ$

The orientation is completed by adjusting each azimuth circle to read the azimuth of the axis of the bore.

(2) *Convergence.*—In special situations, the guns of a fixed battery may be adjusted to converge on a central point in the field of fire. If this result is desired, the adjustment consists of making the azimuth circles of each gun read the same azimuth when directed at the point of convergence. The convergence of guns by means of a flat correction is only practical where the field of fire is narrow. Large errors are introduced at target azimuths much different from the azimuth at which convergence was effected. This adjustment may be made either with the aid of a boresight or by computation.

Example b: The orientation of the guns referred to in example *a* is completed. It is now decided to adjust the azimuth circles so that when both guns are set at 165° azimuth the two guns will converge on a point at an azimuth of 165° and a range of 15,000 yards.

Required: The amount and direction of the convergence correction to be applied to each gun and the method of application.

Solution: The amount of the convergence necessary for each gun in order that the two guns may converge at the center of the field of fire is equal to the parallax angle subtended at the center of the field of fire by one-half the distance between the guns. The direction of the convergence correction may be determined by inspection of figure 113.

No. 1 gun must be moved to the left, and No. 2 gun must be moved to the right. The computations are as follows:

$$\text{tangent of the parallax angle} = 50/15000 = 0.0033$$

$$\text{parallax angle} = 11'27'' = 0.19^\circ$$

The convergence corrections are:

No. 1—left 0.19°

No. 2—right 0.19°

The corrections may be applied with the gun pointed at any azimuth.

The adjustment of No. 1 gun may be made as follows:

Assume that the gun is pointing at 143.08° azimuth. Adjust the azimuth index to read $143.08^\circ + 0.19^\circ = 143.27^\circ$. If the gun is now traversed until the original azimuth, 143.08° , is set, the axis of the bore will be pointing 0.19° to the left of that azimuth. No. 2 gun may be adjusted by making the azimuth circle indicate 0.19° less than the actual azimuth.

NOTE.—In the special cases where convergence is desired, this adjustment would be combined with the check of orientation discussed in example *a*. Instead of displacing the azimuth indexes to read the actual azimuths of the bores, displace them to read the adjusted azimuths as follows:

No.	Actual azimuth	Adjusted azimuth
1	143.08	143.27
2	205.50	205.31

c. Operation.—(1) *Movable index and micrometer screw.*—

The azimuth setter sets the hundredths of a degree on the micrometer screw subscale and traverses the gun until the index is opposite the whole degree graduation mark on the azimuth circle.

(2) *Fixed subscale.*—The azimuth setter traverses the gun until the whole degree graduation mark on the azimuth circle is opposite the hundredths of a degree on the subscale.

■ 134. DETERMINATION OF AZIMUTH OF AXIS OF BORE.—*a.* (1) *Gun pointed at datum point.*—The simplest way to point a

gun at a known azimuth is by direct observation along the axis of the bore at a datum point. The observation is made by means of a rear boresight and a thread held against the muzzle at its vertical diameter or, on the 155-mm M1 gun, by means of the rear and front boresights. In some cases the operation is made easier by using the vent in the breech-block instead of the boresight.

(2) *Gun pointed at a transit.*—If the gun is emplaced so that it cannot be pointed at a permanent datum point, a temporary datum point may be set up. This consists of a transit set up over a point visible from the gun and from which a line of known azimuth may be established. It may be possible to establish this line by pointing the transit at a datum point whose azimuth from the transit position is known. If not, an oriented azimuth instrument may be pointed at the transit and the back azimuth of that line taken. Next, the angle between that orienting line and the line from the transit through the pintle center of the gun is measured. The latter line is located by pointing the transit and the gun at each other so that the axis of the bore coincides with the line of sight of the transit. The angle orienting line-transit-pintle center combined with the azimuth of the orienting line will give the back azimuth of the axis of the bore. (See example *a*, par. 133, and example *e*, par. 135.)

b. (1) Telescope pointed at datum point.—If a gun equipped with a panoramic telescope is so emplaced that it cannot be pointed at a datum point at which the telescope can be pointed, the azimuth of the axis of the bore may be determined by measuring with the telescope the angle between the line of sight to the datum point and the line through the telescope parallel to the axis of the bore. The procedure is as follows: Boresight the gun and telescope to establish parallelism and record the reading of the telescope. Direct the telescope at the datum point and record the reading. From the recorded data compute the azimuth at which the axis of the bore is pointing. In practice, the operation is usually done by setting the azimuth of the datum point on the telescope while the line of sight is parallel to the axis of the bore. If the telescope is then pointed at the datum point, the indicated reading will be

the azimuth of the axis of the bore. (See examples *c* and *e*(2), par. 135.)

(2) *Telescope pointed at a transit.*—If a gun equipped with a panoramic telescope is so emplaced that neither the gun nor the telescope can be pointed at a permanent datum point, a combination of the methods in *a* (2) and *b* (1) may be used. Determine the angle at the transit between the oriented azimuth instrument (or datum point) and the telescope, and the angle at the telescope between the transit and the line of sight when it is parallel to the axis of the bore. These angles combined with the azimuth from the transit to the azimuth instrument will give the back azimuth of the axis of the bore. (See example *e* par. 135.) After the original orientation has been completed, steps should be taken before the axis of the bore is moved to determine suitable data for checking the orientation without the use of a transit. This may be done by determining the azimuth of a fixed reference point at least 1,000 yards from the gun on which the orientation may be checked by the method given in (1) above.

c. Use of alternate aiming points with mobile artillery.—As it is always possible that an aiming point may be destroyed by enemy action, it is advisable to have orientation data for more than one aiming point so that, if necessary, a change can be made quickly from one aiming point to another. The following method is presented as a solution to this problem. Several aiming points are selected when going into position. The azimuth of the bore is determined by any convenient method. The telescope is set on No. 1 aiming point, and the azimuth scale and micrometer are slipped until they read the azimuth of the axis of the bore. If the telescope is now turned until it is parallel to the axis of the bore (see note), the azimuth scale and micrometer will indicate the azimuth to No. 1 aiming point. This should be marked on the gun or carriage near the telescope, preferably by painting (marking on a card or piece of paper is not a good method as the paper may be misplaced). The telescope should then be set on No. 2 aiming point, and the azimuth scale and micrometer again slipped to read the azimuth of the axis of the bore. The telescope is then turned parallel to the bore and the azimuth to No. 2 aiming point is read and

recorded. This can be repeated for any number of aiming points. If it becomes necessary to shift to a new aiming point during firing, the telescope is set parallel to the bore and the azimuth scale and micrometer are slipped to read the azimuth of the aiming point it is desired to use. The telescope is now oriented for use on the new aiming point.

NOTE.—*Setting the telescope parallel to the axis of the bore.*—The method used in setting the telescope parallel to the bore will depend on the telescope in use. If the M8 telescope is used, set the right hand deflection scale to 10. Some telescopes can be set close enough for emergency purposes by setting the head indexes together. The telescope can also be set parallel to the bore by setting the scale and micrometer to the azimuth of the old aiming point before slipping the scale.

■ 135. ADJUSTMENTS IN DIRECTION FOR MOBILE ARTILLERY.—*Example a:* The panoramic telescope graduated in mils on a

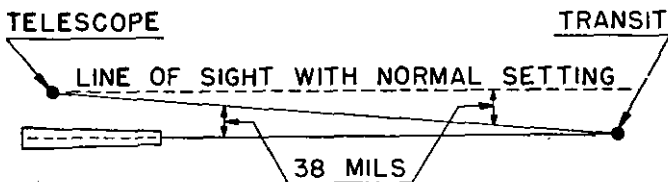

FIGURE 114.—Boresighting by transit (example a, par. 135).

155-mm gun is being boresighted for case II pointing by a transit set up in front of the gun as shown in figure 114. The parallax angle is found to be $2^{\circ}8'$ or 38 mils. The normal of the deflection reference numbers used is 200. Therefore, it is desired to adjust the azimuth scale to read 200 mils when the line of sight is parallel to the axis of the bore. The telescope is pointed at the transit and reads 162 mils.

Required: The necessary adjustment to the telescope.

Solution: The telescope is in adjustment. The deflection setting of 162 mils is, according to the rule, "Right, Raise—Left, Lower," equivalent to a deflection of left 38 mils which agrees with the conditions shown in figure 114.

Example b: An 8-inch railway gun equipped with a panoramic telescope is pointed by boresighting at a distant datum point at 230.26° azimuth. An aiming point of unknown azimuth has been selected for use in case III pointing.

Required: The orientation of the telescope for case III pointing.

Solution: Point the telescope at the aiming point and adjust the azimuth scale and micrometer to read the azimuth of the axis of the bore, 230.26° .

Example c.—A 155-mm gun equipped with a panoramic telescope M3A1 is so emplaced that it cannot be pointed at an instrument or point of known azimuth. The telescope has been adjusted so that when the reference mark on the limb is opposite the fixed azimuth index, the line of sight is parallel

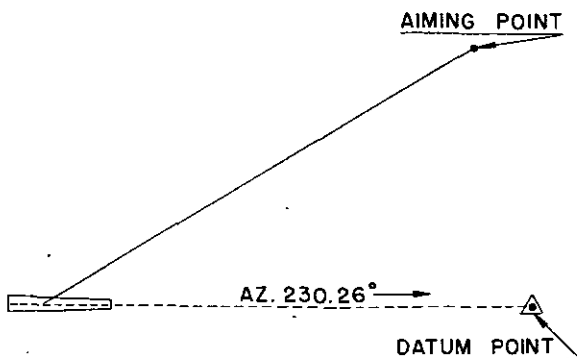

FIGURE 115.—Orientation of telescope on datum point (example b, par. 135).

to the axis of the bore. The azimuth to a datum point at which the telescope can be pointed is 337.50° . The reading on the telescope when the line of sight is parallel to the axis of the bore is 112.50° . The telescope is pointed at the datum point and reads 191.25° .

Required: The azimuth of the axis of the bore.

Solution: The readings of a panoramic telescope increase as the line of sight is moved to the left. The axis of the bore is pointed 78.75° to the right of the datum point. This angle is the difference in the telescope readings, 191.25 and 112.50 . The azimuth of the axis of the bore may be found by adding 78.75° to 337.50° , the azimuth of the datum point, giving 416.25° . Corrected to an angle less than 360° , it becomes

56.25° (416.25° minus 360°), the azimuth of the axis of the bore. (See fig. 116.)

Example d: Continuing the situation in example c above, the datum point is to be used as an aiming point for case III pointing.

Required: The azimuth reading that should be set on the telescope to complete the orientation.

Solution: The azimuth reading should be the azimuth of the axis of the bore, 56.25° .

Example e: (1) An 8-inch gun on railway mount is being oriented for case III pointing. The azimuth of the axis of the bore is unknown, and there is no datum point visible from the gun or the panoramic telescope with which it is

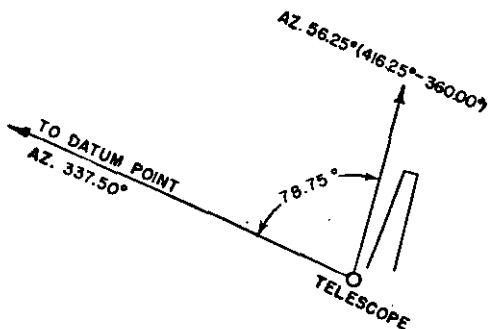

FIGURE 116.—Determination of azimuth of gun by telescope and datum point (example c, par. 135).

equipped. There is, however, a position visible from the gun position from which the azimuth to a visible datum point is known. That azimuth is 125.60° . A transit is set up over this position and the following records made:

A vernier reading

Transit pointed at datum point..... $0^\circ 0'$

Transit pointed at telescope..... $296^\circ 49'$ or 296.82°

Required: The azimuth of the transit from the telescope.

Solution: This example is illustrated in figure 117.

Difference in azimuth.....	296.82°
Azimuth from transit to datum point.....	125.60°
	<hr/>
	422.42°
Subtract.....	360.00°
	<hr/>
Azimuth of telescope from transit.....	62.42°
Add.....	180.00°
	<hr/>
Azimuth of transit from telescope.....	242.42°

(2) The line of sight of the telescope is placed parallel to the axis of the bore, and the azimuth circle adjusted to read

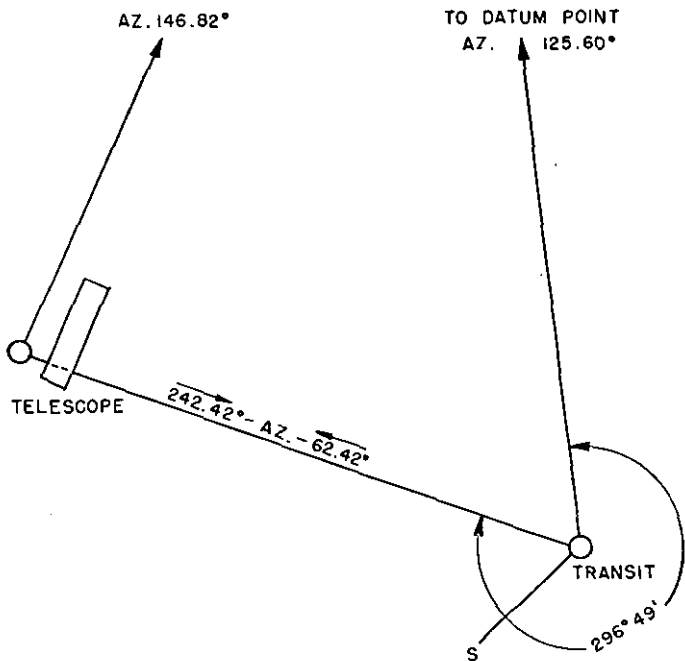

FIGURE 117.—Determination of azimuth of gun by transit and telescope (example e, par. 135).

the azimuth to the transit. It is then directed at the transit and reads 146.82° .

Required: The azimuth of the axis of the bore.

Solution: The azimuth of the axis of the bore is the azimuth indicated by the telescope or 146.82° .

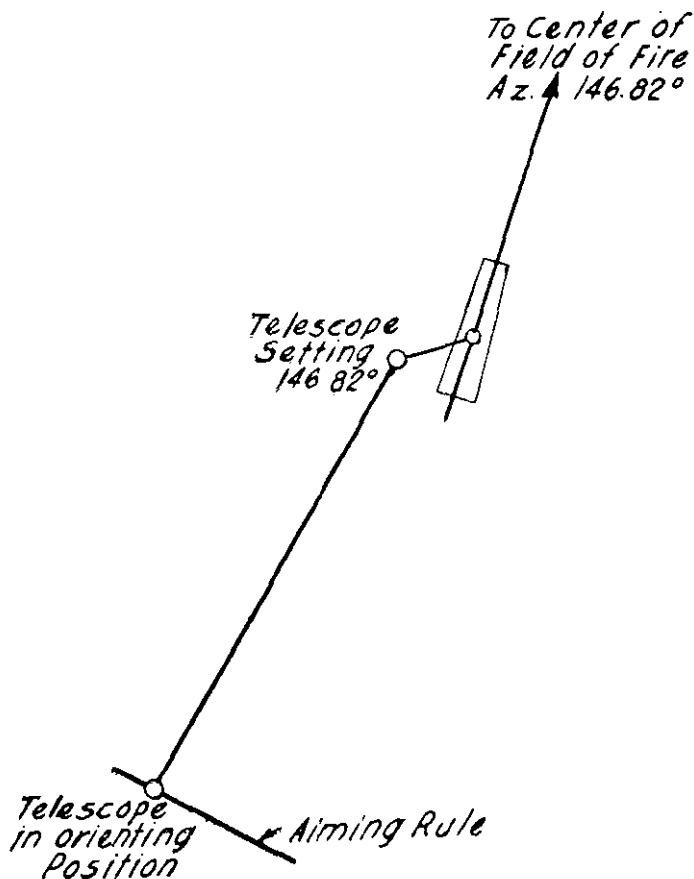

FIGURE 118.—Orientation of aiming rule.

(3) With the axis of the bore at the same azimuth, 146.82° , the telescope is to be oriented for case III pointing, using an aiming rule set up in rear of the gun. (See fig. 118.) The aiming rule telescope is placed in its orienting position, as shown in the figure, and the two telescopes are directed at each other.

Required: The correct azimuth setting that should be made on each telescope to complete the adjustment.

Solution: The setting on the gun telescope should be the azimuth of the axis of the bore, 146.82° . The setting on the aiming rule telescope is immaterial. It may be any setting that happens to be indicated. (The setting should, however, be recorded as well as one on a distant reference point for use in readjusting the aiming rule telescope.)

■ 136. FIELD ARTILLERY TELESCOPE.—Instead of the telescopes prescribed for seacoast artillery, there is a possibility that a battery of 155-mm guns may have panoramic telescopes designed for field artillery. Field artillery telescopes have a fixed azimuth scale graduated in the opposite direction from the seacoast artillery telescopes and set to read zero when the telescope is pointed parallel with the bore of the gun. In order to use these telescopes with seacoast artillery position finding equipment, see appendix IX.

■ 137. DATA TRANSMISSION SYSTEM INDICATORS.—*a. General.*—If a gun is equipped with an elevation or azimuth receiver designed for an electric data transmission system, the gun can be set in azimuth or elevation by positioning the mechanical dial. The gun must be leveled and the mechanical indicators must be oriented to indicate the azimuth and elevation at which the gun is laid. The receiver clocks can then be used as azimuth and elevation dials. The gun is laid by turning the elevation and azimuth handwheels until the mechanical pointers indicate the desired firing data on the graduated scales.

b. Orientation of mechanical pointers on electric data transmission system.—(1) *Azimuth.*—The mechanical azimuth pointers on an electric data transmission receiver are oriented when they indicate the azimuth at which the bore is pointing. The azimuth of the bore may be determined

by boresighting the gun on a datum point or by any of the methods discussed in paragraph 134. To adjust the mechanical pointer to read the azimuth of the bore, an adjustable coupling is provided on some guns which is located between the indicator and the traversing mechanism. The coupling has two screws, the clamping screw that locks the device, and the adjusting screw which actuates a worm wheel on the shaft and permits movement of the mechanical pointers independent of movement of the gun. The adjusting screw is easily identified by a slot at each end. The adjustment is made as follows:

(a) Set bore of gun at a known azimuth.

(b) Loosen the clamping screw.

(c) Turn the adjusting screw until the mechanical pointers indicate the azimuth of the bore.

(d) Tighten the clamping screw.

(2) *Elevation.*—Orientation in elevation is accomplished in a similar manner, the determination of the quadrant elevation of the bore being effected by a clinometer.

c. Synchronization of electrical pointers.—The electrical azimuth and elevation pointers on the receivers are in synchronization when they indicate the same data that are set on the transmitters in the plotting room. If a constant difference exists between the transmitted and received data, synchronization may be accomplished as described below.

(1) *Synchronization for azimuth.*—(a) Remove the plugs on the top of the case to gain access to the adjustable coupling, which is similar to the one installed for the mechanical pointers.

(b) Energize the system and set an azimuth on the transmitter which will bring the adjusting screws near the top where they are accessible through the opening. It will be convenient if the azimuth selected is an even number, such as 300, as used in this example.

(c) Loosen the clamping screws and, using the wrench provided, turn the adjusting screws until the coarse azimuth indicator reads 300 and the fine azimuth indicator reads 0.00.

(d) Tighten the clamping screws.

(e) Replace the plugs.

(2) *Synchronization for elevation.*—The elevation pointers are synchronized as described in (1) above.

NOTE.—If the necessary adjustment is so great that the adjusting screws are moved around so far that the adjusting wrench can no longer be used conveniently, it will be necessary to select a new azimuth of elevation and bring the adjusting screws back to the top position. This can be repeated as often as necessary until the adjustment is effected. Additional adjustments that may become necessary due to improper functioning of the system should be made after consulting the appropriate Ordnance Department publication.

CHAPTER 14

SPOTTING SYSTEMS AND DEVICES

	Paragraphs
SECTION I. General	138-141
II. Spotting board M3.....	142-147
III. Other spotting board.....	148-149
IV. Range rake.....	150

SECTION I

GENERAL

■ 138. PURPOSE.—Even though thoroughness and care are used in determining nonstandard ballistic conditions and in applying corrections in direction and range, there are times when those conditions and their effects cannot be determined with sufficient accuracy to place the center of impact on the target. Therefore, it is necessary to use observation of fire, or spotting, which is the determination of the deviation of a single shot or of the center of impact of two or more shots. These spotting data are then used in the adjustment of fire to determine adjustment corrections which are necessary to bring the center of impact on the target. Since the gun is pointed in range and in direction independently, adjustment corrections in range and in direction are determined independently. This means that the absolute deviation of an impact must be determined in terms of its two components: the range deviation along the gun-target line and the lateral deviation perpendicular to the gun-target line. The same observations may be used to determine range and lateral deviations.

a. Range deviations are determined as a percentage of the range or are sensed, as, "over," "hit," or "short."

b. Lateral deviations are determined normally in angular units, in degrees and hundredths, or in mils. Spotting on naval targets must be speedy and accurate. This requires simplicity of method and careful training of personnel.

■ 139. SPOTTING OBSERVERS.—*a.* The instrument ordinarily employed by the spotting observer is the azimuth instrument. With it he determines the angular deviation of the splash from the observer-target line. The determination of the angular deviation is made by tracking the target with the vertical cross wire of the instrument until the splash occurs. The instrument is then held stationary and the angular deviation of the splash is read by means of the deflection scale etched on the reticle. (See par. 46*a.*) (Refer to

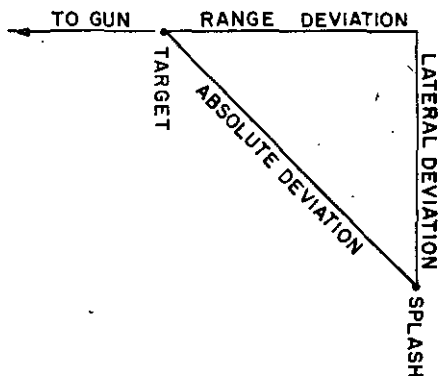

FIGURE 119.—Components of absolute deviation.

figures 18 and 23 for diagrams of reticles of M1910A1 and M1918 azimuth instruments.)

b. If firing is conducted by salvos, with all guns fired together, the observer must estimate the center of impact of the group of splashes as seen from his station and make his reading on that point. For convenience in marking the estimated position of the center of impact, a splash pointer is provided in the instrument used for spotting. When the splash pointer has been moved to this estimated position, the scale is read. This reading gives the correction corresponding to the deviation. The ability to determine accurately and promptly the deviation of centers of impact is gained only

by thorough training and experience. When the salvo is staggered, more accurate spotting is possible because the splashes are spotted separately. Training of spotting observers is one of the most important phases of the development of an efficient spotting system; the failure to realize the difficulties involved and to provide proper means for training and practice is the usual cause of failure of the system.

■ 140. SPOTTING STATIONS.—The spotting system may use one or more terrestrial spotting stations. Properly selected spotting stations will have the same characteristics as properly located observation stations. The requirements are, in order of importance, an excellent view of the field of fire, sufficient height of site, suitable base line if spotting is by the two-station method, proper facilities for communication, non-interference by searchlights, natural or artificial concealment, and protection from enemy fire.

■ 141. SPOTTING SYSTEMS.—*a. Range spotting.*—The object of range spotting will be to determine either the sense only, or the sense and magnitude of the range deviation.

NOTE.—The term "sense" in spotting refers to the direction of the splash from the target; that is, over or short.

(1) *Sense only.*—This type of spotting is utilized by rapid-fire batteries less than 8 inches in caliber. It may be used also in an emergency for the larger caliber batteries. It furnishes data (over, hit, and short) suitable only for the bracketing method of fire adjustment. (See ch. 15.) This method requires only one station. If this station is within 5° of the target-gun line (measured at the target), it is known as an axial station; if between 5° and 75° it is known as a unilateral station; and if between 75° and 105° it is known as a flank station.

(a) *Axial spotting.*—Because of its simplicity and speed, this method is used for rapid-fire guns. The observer, from an axial observation station, tracks the target with an instrument and locates the splash as over or short of the target. The range sensings are more accurate if the splash is in line with some portion of the target. When this is the case, it

can be determined whether the splash is over or short. Attempting to sense shots for range when the splash is not in line with the target (note following) is bad practice unless the height of site of the station is such that the relative positions of the splash and the target are perfectly clear. When there is any doubt about the sensing of a shot, it should be called "doubtful." Since lateral deviations are usually small, all but a few splashes may be expected to be in line with a

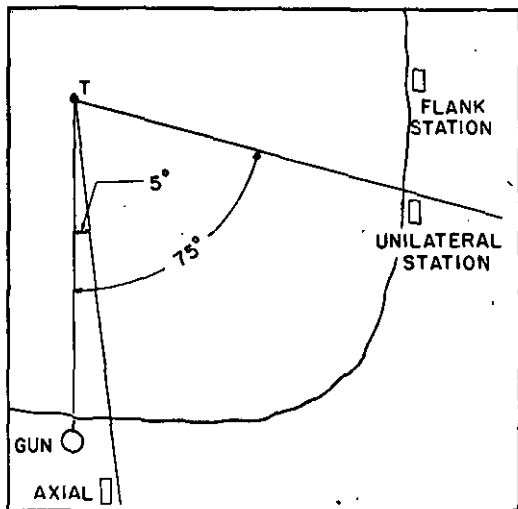

FIGURE 120.—Spotting station types.

portion of the target and sensings may be determined without difficulty.

NOTE.—Since splashes will very seldom be in line with a pyramidal target, due to the small size of the latter, instructions for target practice authorize the use of two-station (or flank) spotting to obtain range sensings.

(b) *Flank spotting.*—This is a special condition utilizing a single station with a line of sight approximately at right angles to the gun-target line. From such a position an observer can easily determine sensings. Ordinarily, under service conditions flank observations will not be practical.

(c) *Unilateral spotting.*—When a single station is unilat-

eral, that is, when it is neither axial nor flank, the sensings obtained are not reliable for good adjustment.

(2) *Sense and magnitude.*—In order to obtain the sense and magnitude of a range deviation, it is necessary to use two spotting stations (bilateral) and a spotting board. This is the method usually used for 8-inch batteries and larger. The two spotting stations are located at the end of a carefully oriented spotting base line having generally the same requirements as the position finding horizontal base line. (The angle of intersection of the lines of sight from the two spotting stations to the target should be greater than 15° .) In operation, simultaneous observations are taken on the splash from each station, each spotter reading with an azimuth instrument the angular deviations from the target as seen from his station. A spotting board is then used to combine the readings from both stations to give a range correction reading in percent of range for the particular round or salvo. This value is sent to the range fire adjustment board to be used with other readings to determine an adjustment correction.

NOTE.—In bilateral spotting, an observer at an axial station reads on the center of the splash, and an observer at any other station reads on the edge of the splash nearest the battery.

b. Lateral spotting.—The object of lateral spotting is to determine the sense and magnitude of lateral deviations in angular units from the gun-target line. This can be accomplished by one of two methods:

(1) *Axial spotting.*—In this method an observer is stationed near the gun-target line. (For wide fields of fire, he must be near the directing point.) This observer reads with an azimuth instrument the angular deviation to the center of the splash from the target and transmits it to the lateral adjuster.

(2) *Bilateral (two-station) spotting.*—This method is similar to bilateral spotting in range and may be used coincidentally with range spotting. The lateral correction readings are sent from the spotting board to the lateral adjuster. This bilateral system is used for lateral spotting only if the axial method is not possible or, as an emergency method, if the axial method becomes inoperative.

SECTION II

SPOTTING BOARD M3

■ 142. GENERAL.—The M3 spotting board (fig. 121) is a fire control instrument designed for use with a bilateral spotting system. It transforms the angular deviations from each spotting station into deviations from the target on the gun-target line. It divides these deviations into two components, the lateral component read in reference numbers representing degrees, and the range component in reference numbers representing percent of range.

NOTE.—For more details on the mechanical construction and theory of the board, see TM 9-2682. For a discussion of basic assumptions and the solution of formulas, see appendix VIII.

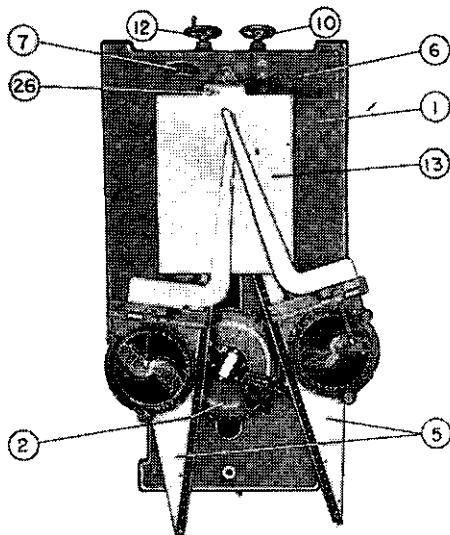

- | | |
|-----------------------|------------------------|
| 1. Base. | 10. Range handwheel. |
| 2. Station arm plate. | 12. Azimuth handwheel. |
| 5. Spotting arms. | 13. Platen. |
| 6. Range counters. | 26. Plunger. |
| 7. Azimuth scale. | |

FIGURE 121.—Spotting board M3—general view.

■ 143. DESCRIPTION.—*a. Base.*—The base (1) (fig. 121) is an aluminum casting supported on a four-legged pipe stand. It houses the range setting drive, the orienting worm drive, the range counters (6) (figs. 121 and 129), and the azimuth scale (7) (figs. 121 and 129). In turn, it provides support for the orienting mechanism and the deviation mechanism. Two removable metal covers underneath protect the mechanisms from dust and shocks. There are three range counters: one, for use with a scale of 600 yards to an inch, permits a maximum range of 15,000 yards; the second, with a scale of 1,200 yards to an inch, permits a maximum range of 30,000 yards; and the third, with a scale of 2,400 yards to an inch, provides for the reading of ranges up to 60,000 yards (see fig. 129).

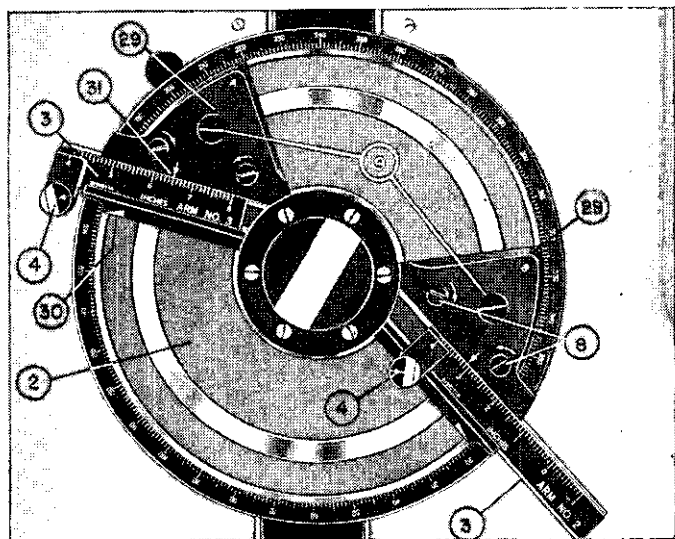

- 2. Station arm plate.
- 3. Station arms.
- 4. Targs.
- 8. Eccentric pins.

- 9. Screw (for clamping guides).
- 29. Guides.
- 30. Guide azimuth index.
- 31. Guide distance index.

FIGURE 122.—Station arm plate with station arms and targs.

b. *Orienting mechanism.*—(1) The orienting mechanism consists of the station arm plate (2) (fig. 121), the station arms (3) (fig. 122), the targs (4) (fig. 122), the right and left spotting arms (5) (fig. 121), and the related parts which serve to set up the geometrical situation in the field to a small scale on the board.

(2) The station arm plate fits over a vertical spindle rotated by a handwheel (12) (fig. 121) from the orienting worm drive in the base and can be lifted off. This same drive also rotates the azimuth scale (7) (fig. 121), which is graduated from 0° to 360° . The station arm plate carries the station arms, which serve to set off to scale the proper distances and azimuths from gun to stations. Each station is represented by a targ that slips into a hole on the end of each station arm. These arms can be locked into place by turning the eccentric pins (8) (fig. 122) in the direction of their arrows. They can be locked in azimuth setting by tightening the screws (9) (fig. 122).

(3) The range-setting drive, operated by a handwheel (10) (fig. 121), consists of a lead screw working through an integral nut on the housing which moves the station arm plate, with its arms along the longitudinal axis of the board. Three spiral gears (11) (fig. 131) attached to the same lead screw turn the counters (6) (fig. 121) which record, each to its own scale, the gun-target range.

(4) The right and left spotting arms (5) (fig. 121) are pivoted on antifriction bearings about a vertical shaft (28) (fig. 123) mounted in a bracket. The center of this shaft is located directly below the center of the deviation grid engraved on the platen (13) (fig. 121), which is also mounted on the bracket. The targs engage grooves in the under side of the spotting arms and indicate the range from the spotting stations on the scales (14) (fig. 123).

(5) The spotting station range scales (14) (fig. 123) are graduated, and they are perforated at every tenth graduation with a hole through which the numbers on the underlying strips can be read. These strips are engraved with three series of numbers, representing 600, 1,200, and 2,400 yards per inch (see fig. 124). The appropriate series of numbers is brought into position by rotating the knobs (15) (fig. 124).

(6) The spotting board is equipped with two complete station arm plates and eight pairs of station arms of various lengths (see fig. 127). This permits a second spotting base line to be oriented and held in readiness for immediate use.

c. *Deviation mechanism.*—(1) The deviation mechanism consists of the deviation disk assemblies (16) (fig. 123); the deviation arms (17) (fig. 123), which are mounted on the spotting arms; and the grid engraved on the platen (fig. 125).

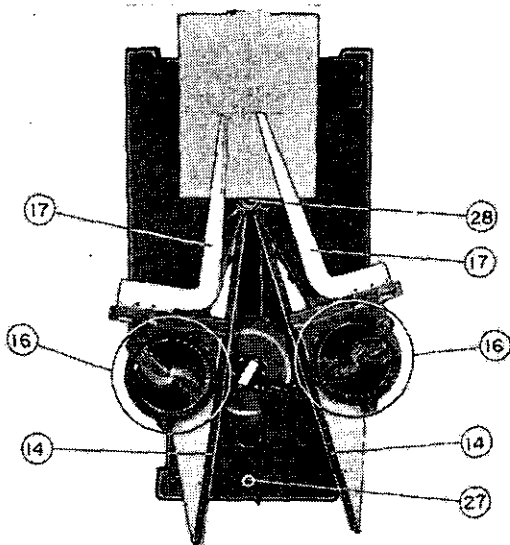

14. Spotting station range scale. 27. Hole for support.
 16. Deviation disk assembly. 28. Vertical shaft.
 17. Deviation arms.

FIGURE 123.—Spotting board M3 with platen withdrawn.

(2) The deviation disks (24) (fig. 126) are engraved with a series of curves permitting a direct setting of the deviations observed in the telescopes or determined by other means. The white curves are graduated in degrees and hundredths with 3.00 as the normal. The red curves marked 6 to 18 and 22 to 34 (fig. 126) are graduated in degrees with 20 as the normal

and are used for setting large angular deviations of the splash. The periphery of the disk is graduated with a logarithmic scale (21) (fig. 126) labeled "range from spotting station". This range may be set off opposite the index (18), (fig. 126) by turning the knob (19) (fig. 126). This index must be repositioned opposite the outer scale (20) (fig. 126),

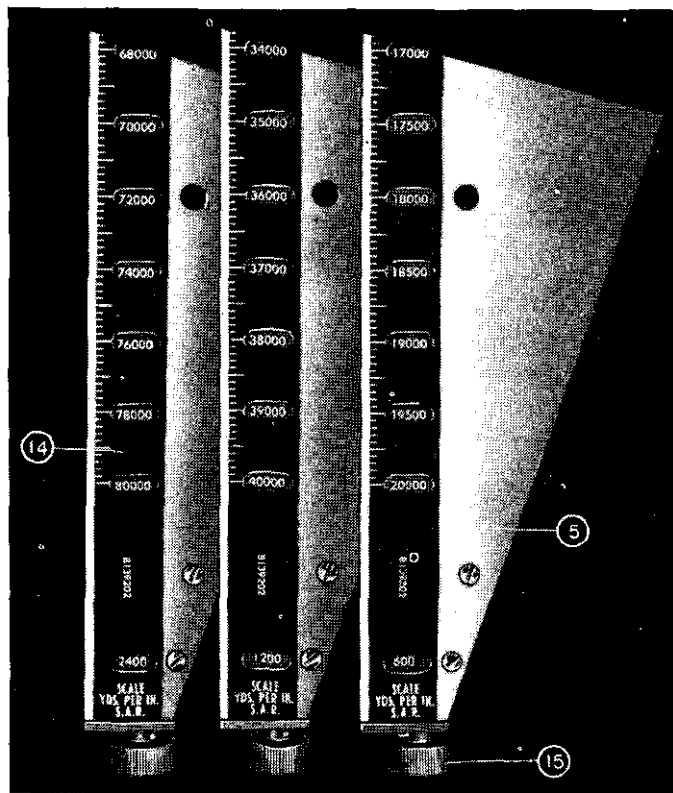

5. Spotting arms.
 14. Spotting station range scale.
 15. Knob (for setting scale (14)).

FIGURE 124.—Spotting arm range scales.

which is similarly graduated in terms of "range from gun," my manipulation of the knob (22) (fig. 126).

(3) The pointers (23) (fig. 126) may be set to the proper deviation lines on the disks (24) (fig. 126) by rotating the knobs (25) (fig. 126). These settings will also move the deviation arms laterally across the spotting arms. The fiducial edges of the deviation arms, representing lines of sight from their respective spotting stations, are always parallel to the inner edges of the spotting arms.

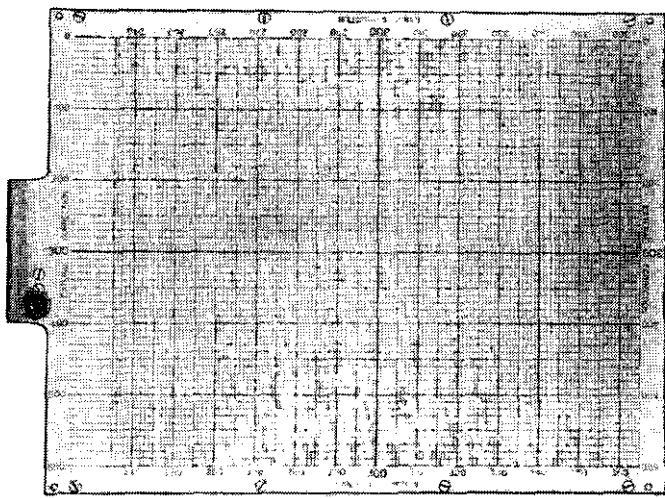

FIGURE 125.—Platen, spotting board M3.

(4) The grid is graduated to permit the reading of corrections for lateral deviations varying from 3° left to 3° right and corrections for range deviations from down 6.5 percent to up 6.5 percent. The 300 mark indicates the normal position in range correction and also in lateral correction.

(5) Depressing the plunger (26) (fig. 121), releases a spring catch, thereby permitting the platen (13) to be withdrawn. When the range from the spotting station to the target is small, it may be necessary to withdraw the platen in order to read the range scales.

d. Support.—The support is a device which is fastened by a chain to the base and fits into a hole (27) (fig. 123) in the base, the pins in the cross member engaging holes in the extremities of the spotting arms. This arrangement prevents the spotting arms from swinging freely about their pivot when the instrument is not in use.

e. Accessories.—A canvas cover for the spotting board and an accessory chest for the extra station arm plate and station arms are furnished with each instrument.

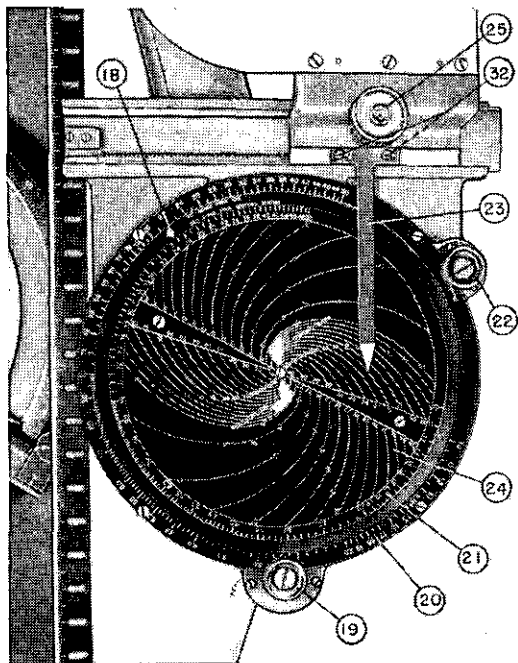

- | | |
|---|------------------------------------|
| 18. Index. | 22. Knob for setting index (18). |
| 19. Knob for setting disk (24). | 23. Pointer. |
| 20. Outer scale, RANGE FROM GUN. | 24. Deviation disk. |
| 21. Inner scale, RANGE FROM SPOTTING STATION. | 25. Knob for setting pointer (23). |
| | 32. Screws holding (23). |

FIGURE 126.—Deviation mechanism, spotting board M3.

■ 144. ORIENTATION.—*a. General.*—Examination of the station plate (2) (fig. 122) shows two guides (29) (fig. 122), one labeled A and the other B. Each has an azimuth index (30) and a distance index (31). These guides carry the station arms. Either guide may be used for any station if there is no mechanical interference between guides. There are eight station arms supplied for each station arm plate (fig. 127). The odd-numbered arms must be used in guide A; the even-

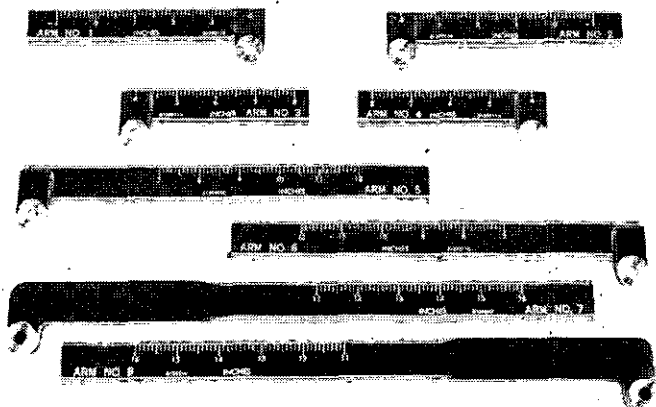
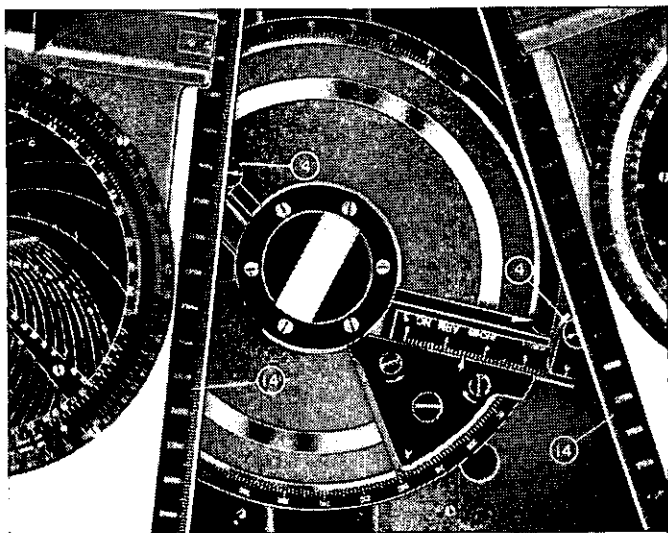

FIGURE 127.—Station arms, spotting board M3.

numbered arms in guide B. When the arms are positioned in the proper guides, the index will indicate on the arm scale the distance between the hole at the end of the arm and the center of the station plate. This represents the distance from a spotting station to the directing point of the battery. The distances covered by each arm are given in the following table.

Arm numbers	From (inches)	To (inches)
1 and 2.....	—1	4
3 and 4.....	4	8
5 and 6.....	7	12
7 and 8.....	11	16

b. Example.—For purposes of illustration, the following orientation data are used to explain the method of setting up the station arm plate. The scale of 1 inch equals 1,200 yards is chosen. Azimuth of DP-S1 equals 17.10° , distance DP-S1, 3,720 yards; azimuth of DP-S2 is 165.07° , distance DP-S2, 7,800 yards. Assume that guide A will be used for the S2 station. The distance of the spotting station from the DP divided by the scale of the board will give the distance in inches that the spotting station targ must be located from



4. Targs.
14. Spotting station range scale.

FIGURE 128.—Station arm plate showing spotting arms in place on targs.

the center of the station arm plate. For S1 this distance is $3720/1200=3.1$ inches; and for S2, $7800/1200=6.5$ inches. The procedure is as follows (see fig. 128):

(1) Choose the proper station arms, in this case No. 3 for S2 and No. 2 for S1.

(2) Insert No. 3 in guide A and clamp at 6.5 inches from the DP.

(3) Insert No. 2 in guide B and clamp at 3.1 inches from the DP.

(4) Set guide A at the azimuth *from DP to S2*, 165.07° .

(5) Set guide B at the azimuth *from DP to S1*, 17.10° .

(6) Bring the proper range scales, in this case the 1,200 scale, into position on the spotting arms by turning knob (15) (fig. 124) until 1,200 appears in the window at the end of each arm.

(7) Insert the targs in the holes in the station arms and place the spotting arms in position on the targs (4) as

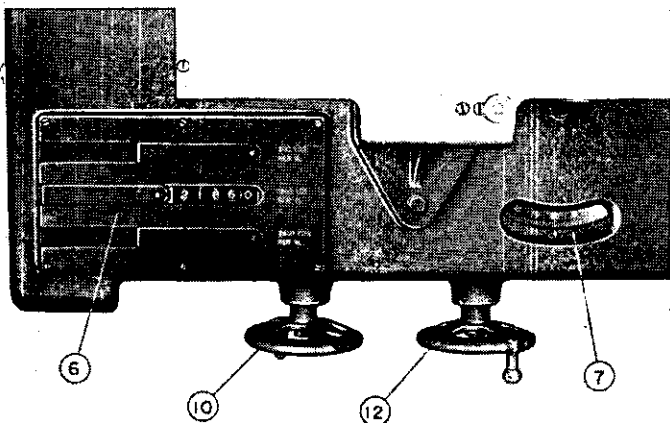

6. Range counters.
7. Azimuth scale,

10. Range handwheel.
12. Azimuth handwheel.

FIGURE 129.—Range and azimuth setting controls, spotting board M3.

shown in figure 128. When the azimuth handwheel (12) (fig. 129) is turned until the azimuth scale (7) (fig. 129) indicates the azimuth of the target, and when the range handwheel (10) (fig. 129) is turned to the proper range counter (6) (fig. 129), the arrows on the targs (4) (fig. 128) indicate the ranges from each spotting station to the target. The board now represents to scale the actual situation on the ground, the center of the station arm plate being the DP, the two targs representing S1 and S2, and the arm pivot

representing the target (28) (fig. 123). The center of the grid should be directly above the pivot during operation.

■ 145. OPERATION.—*a. General.*—From three to five operators should be used on the spotting board: two men for the deviation disks, each connected by telephone to the proper spotting station; one man for setting in map ranges and azimuths; one man to read the deviations on the grid; and a recorder.

b. Procedure.—In following the procedure, refer to figure 129.

(1) Set the approximate range and azimuth to the set-forward point as received from the plotting board. The recorder lists the ranges and azimuths as the plotter determines them.

(2) When the gun is fired, the recorder calls off the range and azimuth corresponding to the round or salvo fired. Set these into the board by the range and azimuth handwheels. Do not change these readings until the angular deviations from the spotting stations have been received and the corrections on the grid determined.

(3) Move the index (18) (fig. 126) to the reading on the outer scale of the deviation disk assembly which represents the range from the gun to the target and which is shown on the range counter.

(4) Rotate the disk until the range from the spotting station to the target (21) (fig. 126) appears opposite the index (18). Obtain this range from the spotting range scale opposite the station targ (4) (fig. 128).

(5) Move the deviation pointer (23) to the angular deviation received from the spotting stations.

(6) Read the reference numbers indicated at the intersection of the two arms on the grid. In this case, (see fig. 130) the lateral reference number of 287 would indicate a correction of left 0.13° . The range reference number is 247 and indicates a range correction of minus 5.3 percent.

c. Summary.—The input data of the spotting board include uncorrected range and azimuth as determined on the plotting board and angular deviations of the splash from the target as read at each spotting station. The output data are reference numbers in the form of corrections which

must be sent to the range adjustment board and the lateral adjustment board before the ultimate corrections can be determined. If a three-way station method of spotting is employed, an axial station telephones lateral deviations directly to the lateral adjustment board; consequently, only the reference number signifying percentage of the range need be read.

■ 146. MECHANICAL CHECK OF BOARD.—The spotting board is an instrument which requires reasonable care but should

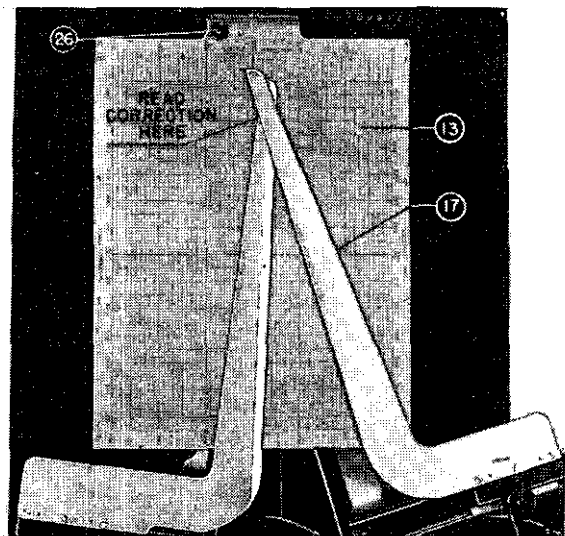

- 13. Platen.
- 17. Deviation arms.
- 26. Plunger.

FIGURE 130.—Platen and deviation arms, spotting board M3.

need little adjustment in the field. The following steps will check its mechanical accuracy:

a. Select a suitable station arm, No. 1 or 2, and set it to zero so that the targ is directly over the center of the station arm plate.

b. Engage the targ in one of the spotting arms and turn the handwheel until the scale reads zero azimuth.

c. Set the deviation pointer to the center of the deviation disk.

d. If the board is in proper adjustment:

(1) The inner edge of the spotting arm should pass through the 0° and 180° graduations of the azimuth circle.

(2) The fiducial edge of the deviation arm should coincide with the grid line indicating zero lateral correction.

(3) The range indicated at the spotting station targ should be the same as that appearing in the range counter window.

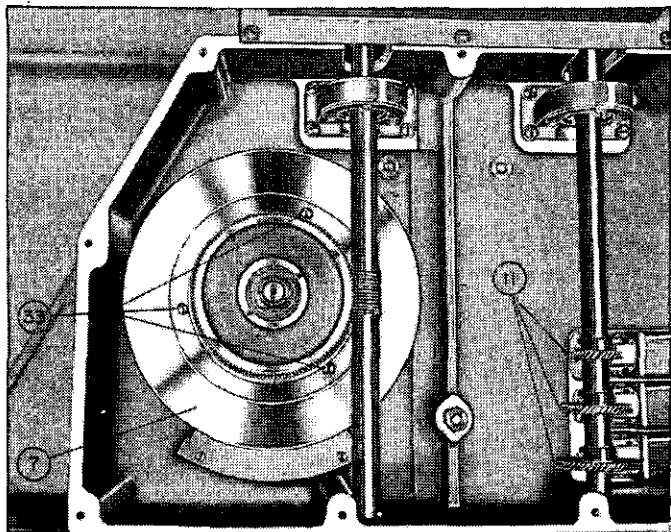

7. Azimuth scale.
11. Three spiral gears.
33. Screws holding azimuth scale.

FIGURE 131.—Azimuth and range indicator mechanisms.

■ 147. MECHANICAL ADJUSTMENT.—a. If the inner edge of the spotting arm does not pass through the 0° and 180° graduation, turn the azimuth handwheel until it does. Remove the cover directly below the azimuth indicator and loosen the three screws (33) (fig. 131) in the azimuth scale assembly.

Rotate the scale (7) (figs. 131 and 129) until it reads zero and then tighten the screws.

b. If the fiducial edge of the deviation arm is parallel to the center grid line but does not coincide with it, turn the knob (25) (fig. 126) until coincidence is obtained. Loosen the screws (32) and shift the pointer (23) until it again coincides with the center of the disk.

c. If the range readings do not check or if any of the other adjustments are insufficient, the instrument should be serviced by trained ordnance personnel.

SECTION III

OTHER SPOTTING BOARDS

■ 148. SPOTTING BOARD M2.—The spotting board M2 is based on the same principles as the spotting board M3. There are, however, a few differences in construction. Range deviations may be determined in percent of the range or in yards. When the board is adjusted to determine range deviations in percent, lateral deviations are read in degrees and hundredths; while if range deviations are in yards, lateral deviations are also read in yards. When it is desired to read range and lateral deviations in yards, the platen and the deviation disks are turned over. The platen on the M2 board is graduated to indicate range deviations in reference numbers. Since the current method of fire adjustment requires that corrections instead of deviations be furnished to the fire adjustment board, the range deviation scale on the platen should be reversed by pasting over the old scale a temporary paper scale with the graduations running in the opposite direction. The lateral deviation scale should be modified in a similar manner (except that the scale will run from 0 on the right to 600 on the left with 300 as normal). The platen will now indicate corrections directly. On the M2 board the azimuth and range handwheels are located on the same end of the board as the station arm plate, while on the M3 board the azimuth and range handwheels are located on the opposite end of the board beside the platen. For spotting station range the spotting board, M2, has only three detachable scales (300, 600, 1,200 yards per inch). Range from the directing

point to the target on the M2 board is set on a scale on the DP-target line. The azimuth on the M2 board is read off the station arm plate. The operation of the M2 board is essentially the same as that of the M3.

■ 149. SPOTTING BOARD M7.—The spotting board M7 is a modification of the M3 board. It determines corrections for range and lateral deviation in the same way as the spotting board M3. It is designed primarily for use with long range batteries where the possibility exists that the angle of intersection, gun-target-spotting station, exceeds 116° . It can also be used with spotting stations that lie more than 20,000 yards from the guns. This is made possible by the following changes: elongating the base casting to provide space for mounting handwheels and scales for setting range and azimuth from both ends of the board; providing longer station arms; modifying the method of mounting the platen and supporting the spotting station arms. The chief modification consists of providing a circular base on the main casting on which the bracket carrying the platen is mounted and pivots. The platen itself can be swung about its center and clamped in position on the bracket. In operation, this will permit the bracket to be swung into a part of the field of fire where it will not interfere with the spotting arms when they are set to the desired position. The platen can then be loosened and reoriented so that the range grid lies along the line of fire. This arrangement permits spotting from any stations whose distance from the DP can be set up on the station arm plate, regardless of the relationship between the gun-target line and the spotting base line.

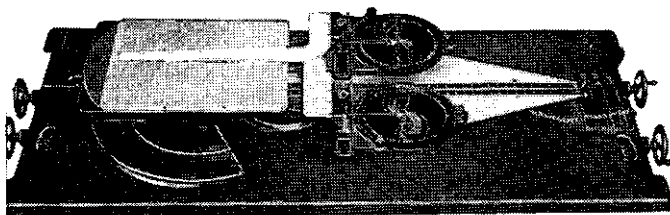

FIGURE 132.—Spotting board M7.

SECTION IV

RANGE RAKE

■ 150. DESCRIPTION AND THEORY.—For reading angular deviations outside the limits of the spotting scale in the azimuth instrument, a device known as a range rake can be constructed. This is ordinarily constructed in the form of a T. At the bottom of the T, a nail is placed as a rear sight. (The operator of the range rake should keep his eye as close to the rear sight as possible. Along the top of the T, a series of nails is placed so that when the rear sight and center front

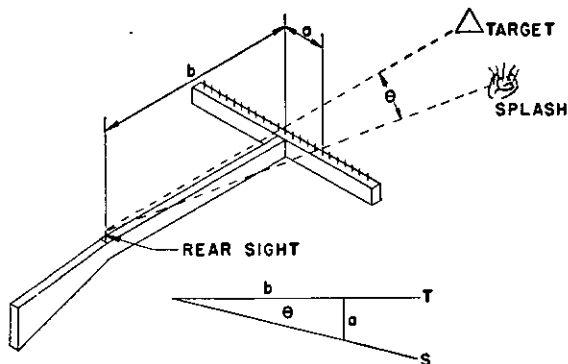

FIGURE 133.—Theory of range rake.

nail are sighted on the target and the splash is sighted over one of the other nails and the rear sight, the angular deviation can be read from a scale painted on the face of the cross piece and visible to the observer. The spacing of the nails must be such that the distance from the center front nail to any nail on the T is equal to the distance from the front center nail to the rear sight multiplied by the tangent of the angle of deviation (indicated on the scale at that nail). A scale is painted on the cross piece showing the angles of deviation corresponding to each nail. When a range rake,

$$\tan \theta = \frac{a}{b}$$

$$a = b \tan \theta$$

graduated in mils, is used on the tug towing a target for target practice, the deviation in yards can be obtained by multiplying the deviation in mils by the length of the tow line in thousands of yards. (One mil is approximately 1 yard at 1,000 yards.) This scale can be graduated in reference numbers to correspond to reference numbers on the spotting scale in the azimuth instrument. If desired, the rear sight can be a peep hole, a V notch, or any convenient device used in sighting. The whole T can be mounted on a rifle stock or a board cut to simulate a rifle stock. A convenient length from front to rear sight would be about 2 feet.

CHAPTER 15

FIRE ADJUSTMENT DEVICES

	Paragraphs
SECTION I. Fire adjustment board M1.....	151-154
II. Bracketing adjustment chart.....	155-157

SECTION I

FIRE ADJUSTMENT BOARD M1

■ 151. PURPOSE.—The fire adjustment board M1 (fig. 134) is the standard instrument used for the adjustment of fire by the magnitude method. In order to take full advantage of the rules for fire adjustment by this method, the person adjusting fire must be able to consider together the deviations of any or all of the shots already fired. If all those shots have not been fired with the same adjustment correction, their deviations cannot be considered together until they have been converted into the deviations that would have occurred if the shots had been fired with the same adjustment correction. Because of lack of time this conversion cannot be done arithmetically. The fire adjustment board solves this problem graphically. Instead of plotting the deviation of each shot or salvo, the correction which would have neutralized the deviation is plotted, since the spots are received in terms of corrections. The board provides means for plotting the corrections reported by the spotting board operators and combining these corrections with the adjustment corrections with which the shot or salvo was fired. The plotted position of each shot or salvo indicates the total adjustment correction which would have brought it upon the target. Therefore, the average plotted correction for any desired number of shots can be determined by inspection and the proper adjustment correction ordered. The board further provides a permanent record of the adjustment.

■ 152. DESCRIPTION.—The board consists of a wooden drawing board mounted on a metal frame 19 by 24 inches in size.

A metal T-square rides in a groove at the left edge of the metal frame and carries a metal slide that can be moved to the left or right. This slide carries a metal scale graduated in reference numbers of percentage of the range, with 200 on the left, 400 on the right, and 300 (the normal) in the middle. The scale of graduations is 1 inch=1 percent or 10 units. The least reading is $\frac{1}{10}$ of 1 percent, or 1 unit. At the top of the board is fastened a slide rule for converting deviations in yards into corrections in percent of the range.

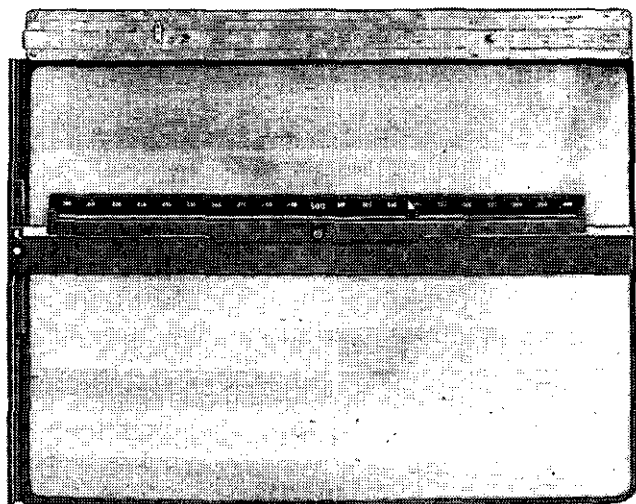

FIGURE 134.—Fire adjustment board M1.

This device is no longer needed with modern spotting boards. A sheet of cross-section paper (10 divisions to the inch) is mounted on the face of the board. In the absence of an arsenal-made board, one can easily be improvised. Any wooden drawing board can be used. No T-square is necessary; a separate scale graduated in the same manner as the scale on the cross-section paper used is sufficient.

■ 153. SETTING UP BOARD.—A piece of cross-section paper, graduated to correspond to the scale on the T-square, is

fixed to the board so that the horizontal lines are parallel to the edge of the T-square. Starting at the heavy vertical line nearest the center of the board, the heavy vertical lines are numbered as follows: 300, 310, 320, etc., to the right; 290, 280, 270, etc., to the left. This numbering should be repeated at intervals to facilitate reading adjustments.

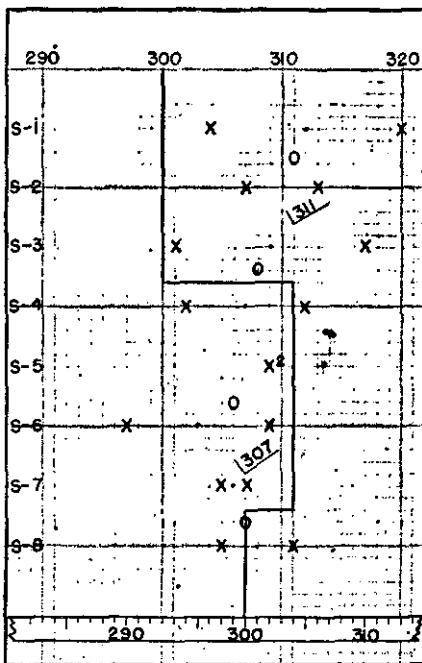

FIGURE 135.—Fire adjustment board M1 showing problem in paragraph 154.

■ 154. OPERATION.—The operation can be explained best by an example. Assume a probable error of 0.7 percent and that one salvo is fired before the correction for the previous salvo can be applied. (See fig. 135.)

a. *Range adjustment.*—To start the adjustment the reading edge of the T-square is brought just below the horizontal

line on which it is desired to start the plot, the normal (300) of the scale on the slide being placed on the 300 line of the paper. Until a correction is made, the 300 line of the chart is the target line (the line from which corrections are plotted), and the scale is not absolutely necessary for plotting. The spots of the first salvo, as read from the spotting board (320 and 304 in terms of corrections in reference numbers), are plotted on the paper on the horizontal line chosen, a cross (x) being used to indicate each shot. The center of impact of the salvo is determined and is indicated on the plot by a small dot (.) placed on the horizontal line between the shots. The second salvo, spotted as 307 and 313, is plotted on the next horizontal line below to be used in the same manner as the first. After the second salvo has been plotted, the center of impact of the two salvos, indicated by a small circle (o), is determined by taking the mean of the centers of impact of the two salvos. Since the center of impact of the two salvos is more than one-half probable error from the target line, the correction indicated (311) is immediately ordered; and a check mark (V) is placed on the vertical line through the center of impact of the two salvos and just below the horizontal line on which the salvo was plotted. The magnitude of the correction (311), as read from the top of the chart, is written in the check mark. Because of the length of the time of flight and of the time required to set the firing data on the guns, this correction cannot be applied to the third salvo. The spots of the third salvo, 317 and 301, are plotted, and the center of impact is determined just as for the first two salvos. Then the target line is drawn vertically downward along the 300 line of the chart to a position just below the third salvo, then horizontally to the line of the correction (311), then vertically downward along the 311 line. The normal of the scale on the T-square is also moved to that line, and the spots of the fourth salvo, 291 and 301, are plotted from this new position.

The center of impact of the fourth salvo is combined with that of the third salvo in the manner previously described; then the center of impact of the eight shots is found by taking the mean of the two centers of impact of four shots. This falls at 310 on the chart. Since this would give a cor-

rection of less than one-half the probable error, no mark is made on the graph. Corrections are usually determined after each new series of four shots, consequently two more salvos are plotted. The two shots of the fifth salvo fell at the same point, 298, and this point is indicated by a cross with an exponent of two (x^2). The sixth salvo was spotted at 286 and 298. The center of impact of the four shots, taken with the center of impact of the previous four, gives a mean on the graph of 307. This gives a correction of 0.4 percent, more than one-half the probable error, and it is immediately ordered. A check mark (\checkmark) is placed on the 307 line, and the number 307 is placed in the check mark. The seventh salvo, 296 and 294, is plotted without moving the normal of the T-square, since this salvo was fired before the correction of 307 could be applied. The target line is then drawn to its new position, below the seventh salvo and on the 307 line, and the eighth salvo, spotted at 298 and 304, is plotted from this new position. If the spotting is by centers of impact, the cross (x) is used for plotting the center of impact on the fire adjustment board.

b. Care must be taken to move the target line at the proper time. If the correction ordered does not take place on the next salvo, that salvo should be plotted from the old position of the target line. The first salvo on which the new correction takes effect will be plotted from the new target line.

c. It may often become impossible to spot by magnitude for one or more salvos. The adjuster must be prepared to adjust using only the sensings of the fall of shots. There are two methods of adjusting using sensings:

(1) By plotting sensings directly on the magnitude adjustment chart. Hits are plotted on the target line; overs and shorts, two probable errors away from the target line. Since the chart is constructed in corrections, overs are plotted on the left, shorts on the right. Centers of impact are determined and corrections ordered just as in the normal method. Conditions may arise in battle making it impossible to determine the magnitude of the corrections. If it is apparent that the conditions will continue for some time, the fire adjuster should change over to the bracketing method (see sec. II) for which a set of charts should be in readiness.

(2) By shifting immediately to a prepared bracketing adjustment chart (see sec. II). The sensings of the last four shots plotted on the magnitude chart can be used on the bracketing chart.

NOTE.—During peacetime target practice, in order to conserve ammunition, it is advisable to use trial fire, that is, to fire four shots, either singly or by salvo, for the purpose of obtaining an adjustment correction to be used in entering fire for effect. Battle conditions, however, usually make it advisable to open up on a target at full rate of fire; therefore, use of trial fire has not been considered as standard practice in this chapter. However, conditions may arise when the battery commander may feel that it is unwise to open fire at full rate, and that "trial fire" may be warranted. The methods of plotting on the fire adjustment board are similar. However, a full correction is applied if the center of impact of the first two shots is more than two probable errors away from the target. Another correction, based on the center of impact of all four shots, can be considered after the third and fourth shots. Thereafter, the method of adjustment is as described. During the trial phase, firing is suspended for the application of adjustment corrections to the firing data.

d. Lateral adjustment.—The fire adjustment board M1 can also be used for lateral fire adjustment, although certain modifications must be made to the ruler and the graph.

(1) The units on the plotting scale or ruler of the T-square must conform to those in which lateral deviations are received. The lateral deviations may be received from a spotting board or from an axially located azimuth instrument under one of the following conditions:

(a) *Azimuth instrument M1910A1.*—The plotting scale in this instrument furnishes data on a splash in terms of the correction to be applied. Corrections are given in degrees and hundredths by means of a reference number system having a normal of 3.00. The plotting scale shown in figure 136 is suitable for use when the azimuth instrument M1910A1 is used to obtain lateral deviations.

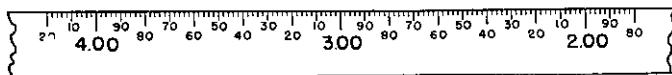

FIGURE 136.—Plotting scale used with azimuth instrument M1910A1.

(b) *Azimuth instrument M1918.*—This instrument has a spotting scale graduated in mils with zero as normal and is

marked with plus and minus values, plus being on the right. In this case deviations will be read as right or left deviations, and, therefore, the scale used should take account of this. Figure 137 shows such a scale. It should be noted that in this case the plotting is done in terms of deviations and not in corrections.

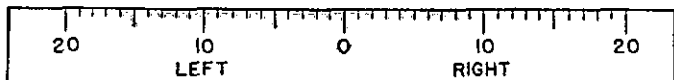

FIGURE 137.—Plotting scale used with azimuth instrument M1918.

(c) *Spotting boards M2, M3, and M7.*—The spotting boards M2 (as converted to read corrections), M3, and M7 furnish deviation data in the same reference number system as that mentioned in (a) above, and, therefore, the scale in figure 135 can be used.

(2) The correction scale used on the cross-section paper must be graduated in the same manner as the adjustment scale on the deflection board, the gun data computer, or the gun sight (when corrections are sent directly to the guns) and it must be consistent in magnitude with the scale of the plotting ruler. Figures 138 through 142 show possible combinations of scales likely to be encountered in lateral adjustment. The upper scale in each case being the correction scale plotted on the cross-section paper and the lower scale being the plotting scale sliding on the T-square. The captions under these figures are self-explanatory.

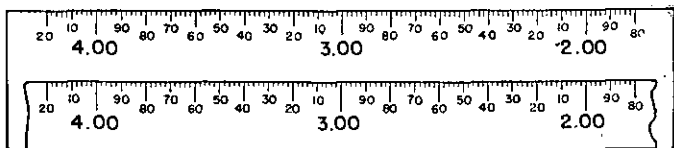

FIGURE 138.—Spotting with azimuth instrument M1910A1—deflection board correction scale in degrees (3.00 normal).

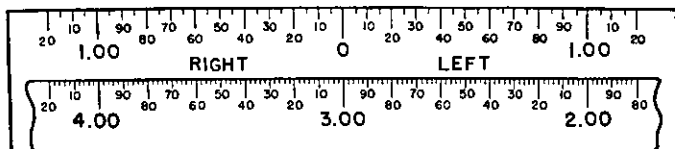

FIGURE 139.—Spotting with azimuth instrument M1910A1—deflection board correction scale in degrees (zero normal).

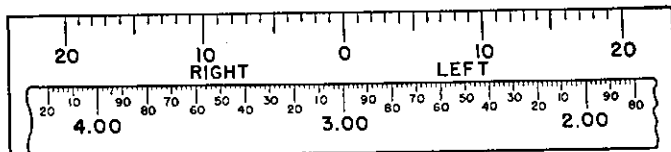

FIGURE 140.—Spotting with azimuth instrument M1910A1—deflection board correction scale in mils (zero normal).

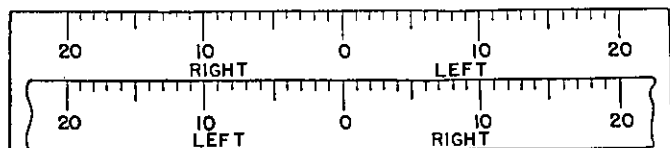

FIGURE 141.—Spotting with azimuth instrument M1918—deflection board correction scale in mils (zero normal).

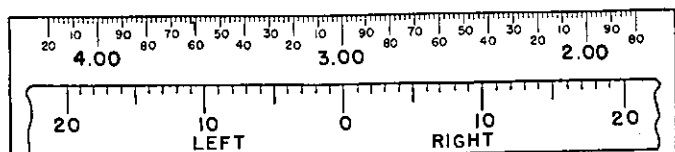

FIGURE 142.—Spotting with azimuth instrument M1918—deflection board correction scale in degrees (3.00 normal).

(3) Plotting for lateral adjustment is similar to plotting for range adjustment. Adjustments are made on a smaller number of salvos than in range adjustment. (For a discussion of the principles of lateral fire adjustment, see FM 4-10.)

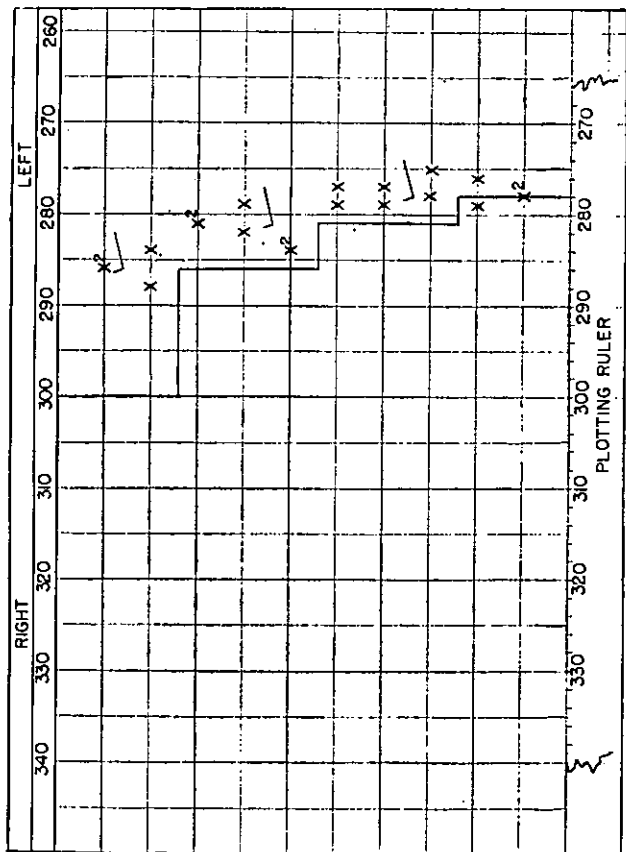

FIGURE 143.—Lateral adjustment of fire on fire adjustment board.

Example.—Spotting with azimuth instrument M1910A1. Deflection board correction scale in degrees with 3.00 normal (see fig. 143).

<i>Salvo No.</i>	<i>Deviations</i>	<i>Salvo No.</i>	<i>Deviations</i>
1	286 (2 shots) adjustment ordered, 286, effective on third salvo.	5	298 (2 shots)
2	288, 284	6	296, 298
3	295 (2 shots)	7	298, 296 adjustment ordered, 278, effective on ninth salvo.
4	293, 296 adjustment ordered, 281, effective on 6th salvo.	8	297, 294
		9	298, 301
		10	300 (2 shots)

SECTION II

BRACKETING ADJUSTMENT CHART

■ 155. GENERAL.—*a.* The bracketing adjustment chart provides a rapid and accurate means of determining and recording graphically the necessary range adjustment corrections for firing when using the bracketing method of adjustment. It does not permit the plotting of stripped deviations; therefore, in using the chart, only those shots that have been fired with the same adjustment correction may be considered together in determining a correction.

b. The chart is based on the over-short rule (see FM 4-10), which is expressed by the equation:

$$C \text{ (correction)} = \frac{S-O}{2(S+O)} \times F.$$

where O = the number of overs

S = the number of shorts

F = the value of the fork (four probable errors)

The fork (F) may be expressed in tenths of 1 percent of the range or in yards. The correction (C) will be given in the same units as are used for the fork.

c. The chart is usually made up to give corrections in percentage of the range for two reasons: First, the corrections are then expressed in the same reference numbers as are used on the percentage corrector and the fire adjustment board; second, the value of the fork in yards for any particular combination of powder charge and projectile varies with the range but usually approximate a fixed percentage of the range. A single chart giving corrections in percentage of the range will ordinarily serve over wide range limits, whereas, if the chart gives the corrections in yards it is accurate only for the range for which it was constructed. The battery must keep on hand charts constructed for different probable errors. Different charts should be made if the value of the probable error changes $1/10$ of 1 percent.

d. The operator of the chart receives the reports of the overs (*O*), shorts (*S*), and hits (*H*) from the spotting section, plots the graph from those deviations, and determines the correction. The correction read from the chart is the correction called for by the shots being considered at the moment. In order to get the proper reference number for use on the percentage corrector, the operator of the chart must add the correction determined on the chart algebraically to the adjustment correction then being used and transmit the resultant (net) correction to the operator of the percentage corrector. This computation may be made and the record of corrections may be kept conveniently on the correction record at the right of the chart.

■ 156. CONSTRUCTION.—*a.* The chart consists of a piece of paper of convenient size on which has been drawn a series of equally spaced vertical and horizontal lines forming a grid, and a diagonal line extending from the upper left to the lower right hand corner. Each vertical line corresponds to a given number of overs and each horizontal line to a given number of shorts. The diagonal line represents the line of zero corrections and separates the chart into halves; all corrections indicated in the upper half are down corrections and should be subtracted; all corrections indicated in the lower half are up corrections and should be added. The grid may be considered as a system of rectangular coordinates

in which the upper left hand corner is the origin, the X coordinates are overs, and the Y coordinates are shorts.

b. For any combination of overs and shorts, that is, for each intersection of vertical and horizontal lines, there is one and only one adjustment correction called for by the over-short rule. The adjustment correction corresponding to each intersection may be computed and indicated on the chart in the desired units. The notations listed following should then be entered on the chart before it is ready for use in adjustment of fire.

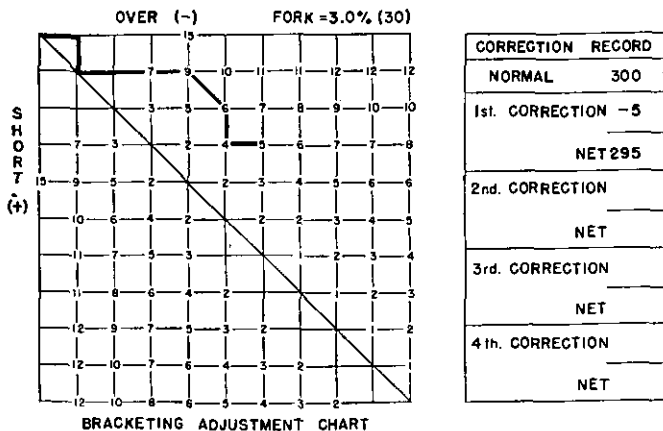

FIGURE 144.—Bracketing adjustment chart, grid type.

c. Figure 144 shows the standard grid type chart constructed for a particular combination of powder charge and projectile which develops a probable error of 0.75 percent of the range (fork=3.0 percent). The corrections are indicated in tenths of 1 percent (1 unit in reference numbers). A grid is constructed to a convenient scale and a diagonal line is drawn in. The number of vertical and horizontal lines should be sufficient to cover the maximum number of shots that it is desired to consider at one time.

A convenient scale to use is 1 inch=2 overs (or shorts). The following notations are inserted on the chart as shown in figure 144.

Over (across the top).

Short (along the left side).

The value of the fork (in the upper right hand corner, expressed in the same units as the corrections).

Correction (—) (in the upper half).

Correction (+) (in the lower half).

Using the formula given in paragraph 155, the correction corresponding to each intersection of vertical and horizontal lines is computed and entered in the appropriate place on the chart. The necessary data for the construction of the chart shown in figure 144 are given in the following table:

Tabulated data for use in constructing chart for fire adjustment by bracketing method (fork=3.0 percent)

S	O	$\frac{S-O}{2(O+S)}$	F	C	S	O	$\frac{S-O}{2(O+S)}$	F	C
3	1	0.25	30	7	8	3	0.23	30	7
3	2	.10	30	3	8	4	.17	30	5
4	0	.50	30	15	8	5	.11	30	3
4	1	.30	30	9	8	6	.07	30	2
4	2	.17	30	5	8	7	.03	30	1
4	3	.07	30	2	9	1	.40	30	12
5	1	.33	30	10	9	2	.32	30	10
5	2	.21	30	6	9	3	.25	30	7
5	3	.13	30	4	9	4	.19	30	6
5	4	.06	30	2	9	5	.14	30	4
6	1	.36	30	11	9	6	.10	30	3
6	2	.25	30	7	9	7	.06	30	2
6	3	.17	30	5	9	8	.03	30	1
6	4	.10	30	3	10	1	.41	30	12
6	5	.05	30	2	10	2	.33	30	10
7	1	.38	30	11	10	3	.27	30	8
7	2	.28	30	8	10	4	.21	30	6
7	3	.20	30	6	10	5	.17	30	5
7	4	.14	30	4	10	6	.13	30	4
7	5	.08	30	2	10	7	.09	30	3
7	6	.04	30	1	10	8	.06	30	2
8	1	.39	30	12	10	9	.03	30	1
8	2	.30	30	9					

This tabulation, as listed, gives values of correction for intersections in the lower half of the chart. If the coordinates

(overs and shorts) are reversed, the tabulation will give values for intersections in the upper half. As an example of entering the corrections on the chart, consider the intersection $X=3$ overs, $Y=6$ shorts. From the tabulation, the correction 5 should be entered at that intersection. The same correction is appropriate for the intersection $X=6$ overs, $Y=3$ shorts (marked by the end of the graph in figure 144 in the upper half of the chart).

■ 157. OPERATION.—*a.* The procedure consists of drawing on the chart a graph of the deviations of a series of shots fired with the same adjustment correction, in the order in which they are reported, starting from the origin. Overs are drawn along a horizontal line, shorts along a vertical line, and hits (being considered as both over and short) along a diagonal. The correction called for by that series is then determined by noting the appropriate correction for the intersection at which the graph stops. In determining whether or not to apply a correction, the operator should be guided by the rules for fire adjustment as given in FM 4-10. The operator adds the correction algebraically to the adjustment correction then being used and transmits the net correction to the operator of the percentage corrector. If desired, a form may be made at the right of this chart, as shown in figure 144, for convenience in making the computations and keeping the record of corrections.

b. As an example of operation, consider the situation illustrated in figure 144. The first salvo was reported O—S—O—O (3 overs and 1 short). The operator of the chart draws the heavy lines shown on the chart, ending the graph at the intersection $X=3$ overs, $Y=1$ short. The next salvo is reported O—H—S—O, which the operator records as shown, continuing the graph to the intersection $X=6$ overs, $Y=3$ shorts. (A hit is counted as one over and one short.) At this point the chart indicates a correction of down 5. The proper reference number for use on the percentage corrector is $300-5=295$. The graph should be continued for any further salvos fired with the adjustment correction of 300. As soon as the operator receives spots on salvos fired with the new correction (295), he should start a new graph either on a new

chart or on the same chart with pencil of another color. The procedure for any further firing is the same as for the first series.

c. The battery commander may consider it necessary to use trial fire under certain conditions. Trial fire is conducted by individually ordered salvos according to the following rules. Trial fire opens with the firing of one salvo. If the impacts of this salvo are sensed—

4-shot salvo	3-shot salvo	2-shot salvo
All in the same sense.	All in the same sense.	All in the same sense.

an adjustment correction of one fork is applied and such correction repeated after each salvo until two corrections differing by one fork are determined, one of which gives overs and the other shorts. Fire for effect is started with that correction which is the mean of the corrections giving the bracket. If, however, in attempting to obtain a bracket, any salvo gives a straddle, the correction with which to enter fire for effect should be obtained in the manner that applies, as indicated in (1) or (2) below.

(1) If the impacts are sensed—

4-shot salvo	3-shot salvo	2-shot salvo
3 overs and 1 short or 3 shorts and 1 over. 1 hit and 3 overs or 1 hit and 3 shorts.	1 hit and 2 overs or 1 hit and 2 shorts.	

an adjustment correction of one probable error is applied in the proper direction. This is the correction with which to enter fire for effect.

(2) If the impacts are sensed—

4-shot salvo	3-shot salvo	2-shot salvo
2 overs and 2 shorts. 1 hit as well as 1 or more overs and 1 or more shorts. 2 or more hits.	1 hit, 1 over, and 1 short. 2 or more hits. 2 overs and 1 short or 2 shorts and 1 over.	1 over and 1 short. 1 or more hits.

no change is made; the correction with which this salvo was fired is the correction with which to enter fire for effect, and the salvo is plotted on the bracketing adjustment chart.

The correction applied must be indicated on the chart.

CHAPTER 16

FIRE CONTROL SYSTEM FOR 3-INCH SEACOAST BATTERIES

■ 158. GENERAL.—*a.* To be effective, the fire control system for 3-inch seacoast batteries must furnish data rapidly and simply. The system described in this chapter is sound and will be very effective under favorable conditions of range, target performance, definition, and visibility.

b. Range is determined by a coincidence range finder or depression position finder. Ranges are read every 5 seconds and set on a percentage corrector on which initial ballistic (see par. 159) and travel corrections are incorporated. Corrected elevations are sent to the guns every 5 seconds. An initial deflection, including a ballistic correction (see par. 159) and a travel correction, is computed and sent to the gun pointer. After fire is opened, no corrections other than those based on observation of fire are made.

■ 159. FIRING DATA CHART.—Initial ballistic corrections are made continuously available by means of a firing data chart (see fig. 145). The field of fire of the battery is divided into subsectors as shown. Considering the over-all accuracy of the entire system and the need for simplicity, these subsectors need not be too numerous. In general, it will be found that ballistic corrections computed for a certain range and azimuth will be suitable for a subsector covering about 30° in azimuth and about 3,000 yards in range. At ranges under 2,000 yards meteorological corrections ordinarily can be neglected; however, corrections for muzzle velocity and drift should be made. As a typical example, assume that a field of fire covers 180° in azimuth and 11,000 yards in range. The subsectors should be formed by dividing the field of fire into 30° sectors (see fig. 145) and subdividing these sectors to form subsectors covering from 2,000 to 5,000, 5,000 to 8,000, and 8,000 to 11,000 yards in range. Ballistic corrections, including meteorological corrections, should be computed for the central point of each of these subsectors and recorded in

reference numbers. The range ballistic corrections should be applied on the percentage corrector when the subsector in which the target will be taken under fire becomes known. Just prior to opening fire, a range correction for the travel of the target during the time of flight plus dead time should be added algebraically to the ballistic correction on the percentage corrector (see par. 160). The initial correction for wind and drift for the various subsectors should be determined in angular units (reference numbers) and recorded for use in determining the total initial lateral correction. This total initial lateral correction (see par. 161) will include the correction necessary for the angular travel of the target during the time of flight which correction should be determined just prior to opening fire. See paragraph 163 for instructions on construction of chart.

■ 160. RANGE AND ELEVATION DETERMINATION.—*a.* Range is determined by a coincidence range finder or depression position finder, if available. Range errors due to displacement of the range finder from the directing point should be reduced to a minimum. The importance of careful selection and training of range finder operators cannot be overemphasized. Training of operators should include extensive tests of range finder accuracy under varying target and visibility conditions to insure that all concerned recognize the capabilities and limitations of the range finding equipment. Ranges should be checked against horizontal base plots. *The majority of the tests should be conducted at night.*

b. Range finder readings are made every 5 seconds. The reading is set on the percentage corrector where a ballistic correction and a correction for travel of the target during time of flight plus dead time are applied. The range correction for the travel of the target during the time of flight plus dead time can be determined by measuring the change in range over a known period of time with the range finder and a stop watch and computing the rate at which the range is changing. This rate is multiplied by the time of flight plus dead time, which is obtained from a tabulation of time of flight plus dead time versus range. The resultant value for range travel can be applied readily on the range percentage corrector by displacing the ballistic pointer the required num-

ber of yards on the percentage corrector tape. For example, if it is calculated that the range will decrease 200 yards during the estimated time of flight plus dead time for the opening salvo, the ballistic pointer should be displaced minus 200 yards. Corrected elevation or range, if range disks are used, is sent to the guns every 5 seconds. If the range disks are not properly graduated for the ammunition being fired, a range-range relation scale should be used on the percentage corrector. If the range disks are graduated in mils, a range-elevation scale calculated for the height of site of the battery should be employed.

■ 161. LATERAL CORRECTION FOR ANGULAR TRAVEL.—The lateral correction for the angular travel of the target during the time of flight may be determined just prior to opening fire by measuring the angular travel of the target during a known period of time by means of an azimuth instrument or the gun telescope and a stop watch, and converting these data to the angular travel during the time of flight for the opening salvo. The correction for angular travel should be added algebraically to the correction already determined for wind and drift to obtain the total initial lateral correction which should be applied on the gun telescopes.

■ 162. ADJUSTMENT OF FIRE.—After the initial corrections in range and direction have been applied and firing has begun, all other corrections should be adjustment corrections. Two azimuth instruments should be provided, one for spotting overs and shorts, and the other for determining lateral deviations. The bracketing method of fire adjustment for range should be employed and adjustment corrections applied in reference numbers as a percentage of range on the range percentage corrector. Lateral adjustment by jumping the splashes is not feasible in service firing, and is now prohibited for target practice. Lateral deviations should be determined by means of an azimuth instrument and the necessary corrections should be telephoned to the gun pointers. As the target moves from one subsector to another while under fire, any change in firing data due to ballistic conditions should be taken care of by fire adjustment and not by computing new ballistic corrections.

■ 163. CONSTRUCTION OF CHART.—Before starting the construction of the sector chart it will be convenient if the firing table data on differential effects are extracted for the mid-range of each subsector. This should be done for density, temperature, muzzle velocity, and wind and drift. When a new meteorological message is received, the wind-fire angle can be computed for the center of each sector; and the range wind and cross wind components can be determined from the wind chart in the firing tables. Wind effect in range and deflection can then be determined for each subsector. The effects for density and temperature and, if necessary, for muzzle velocity can then be combined with that for wind to give the total ballistic effect for range, and the effect for cross wind can be combined with the drift to give the lateral ballistic effect. By changing the sign these effects are converted to corrections. These corrections for each subsector should be noted in pencil on the sector chart as shown in figure 145. In order to be ready to fire at any time, these corrections should be computed and listed after each new meteorological message is received, except that no changes should be made while the battery is firing. When the corrections for change in range during the time of flight plus dead time and the corrections for angular travel have been determined, they are combined algebraically with the ballistic corrections for the subsector in which the target is to be taken under fire to obtain firing data for the first round.

■ 164. RANGE CORRECTION BOARD.—*a.* The time to obtain initial ballistic corrections is considerably shortened by use of a simplified range correction board. This board consists of a wooden box 30 inches long and 6 inches square which contains a single wooden roller 5 inches in diameter. Attached to this roller is a chart 27 inches long, on which the range and curves denoting range effects have been plotted. As the roller turns the effects change. On the top of the box is a movable slotted metal rule. In the slot on the rule is a movable pointer, so constructed that it may be clamped at any position on the rule. Below the metal rule is a scale of corrections in reference numbers, which is read by a fixed index on the rule.

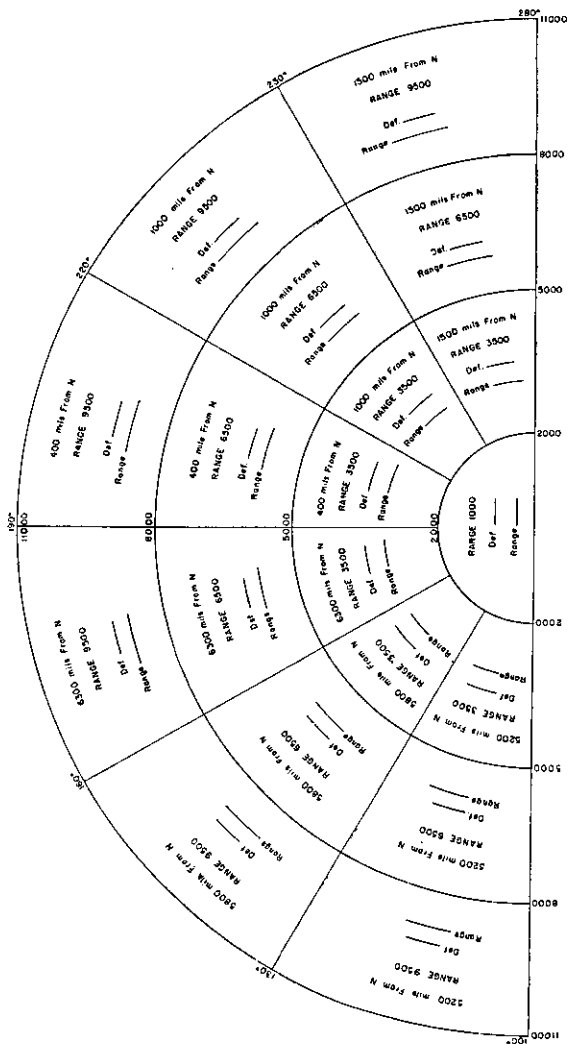

FIGURE 145.—Firing data chart.

b. To operate the board, turn the roller until the desired range is opposite the range index. Zero the fixed pointer on the scale and then slide the movable pointer to the normal of the set of desired curves and clamp it. The metal rule with the pointer is moved to the curve corresponding to the known effect. By moving this rule and pointer to the various effects, the fixed pointer will show the total correction for all effects.

c. The board itself may be made by the using unit. The drawings showing details of construction of this board and the charts for use with it may be obtained from the Coast Artillery Board, Fort Monroe, Virginia.

CHAPTER 17

ALTERNATE METHODS

	Paragraphs
SECTION I. Principles of alternate fire control methods.....	165
II. One-station fire control system.....	166-171
III. Modified one-station method using time-range board.....	172
IV. Central control.....	173-174
V. Gun commander's control.....	175-176
VI. Temporary and stand-by fire control system for 90-mm AMTB batteries.....	177-188

SECTION I

PRINCIPLES OF ALTERNATE FIRE CONTROL METHODS

■ 165. GENERAL.—*a.* Preparations for combat can never be complete until all batteries have made plans to cover every contingency that may arise. Such plans must be well known by every member of the firing organization and should be a part of each battery's standing operating procedure. The standard methods of fire control and position finding used by coast artillery are accurate but complicated. The failure of one element of a fire control system to function might easily cause a breakdown of the entire system. Possible destruction of base-end stations, fire control towers, and particularly communications, makes it of prime importance that batteries be trained to commence or continue firing without hesitation when such a breakdown occurs. The secondary or stand-by systems of fire control are known as alternate methods.

b. Various fire control and position finding systems are listed below in order of preference.

(1) Radar with computer (for batteries with such equipment).

(2) Radar with plotting board.

(3) Horizontal, vertical, or self-contained base with computer.

(4) Horizontal, vertical, or self-contained base with plotting board and other plotting room instruments.

(5) One station method (for batteries which must use case III only).

(6) Central control, with whatever ranging equipment is available.

(7) Gun commander's control.

c. In the event of failure of a battery's standard system, it would automatically revert to the next most preferable, workable system. When that system is out of action, a less desirable method must be used. The only reason for a battery to cease firing when there is an enemy ship to be engaged is the destruction or failure of the guns. The standard system for some batteries may be an alternate method for others. Naturally, each battery will plan to start with its best possible system, but experience in war has shown that sometimes the least preferred was the one that had to be used. This particularly applies to mobile batteries.

d. The decision as to the systems the battery shall use rests with the battery commander, limited by the available equipment. Every battery must be able, however, to fire with no data other than that which can be estimated. The systems explained in this chapter are by no means meant to limit the battery officers in their own exercise of ingenuity in making improvements or changes to accomplish their mission.

e. The effectiveness of any system of fire control is dependent upon numerous factors, the decisive one being the exercise of good leadership and good judgment on the part of the officers and noncommissioned officers. These can be developed only by constant and arduous practice in all methods of fire control. However, there are other conditions which will limit the effectiveness of the alternate methods. Those which apply specifically to one method will be described in the appropriate section. Those which apply in general are:

(1) *Rate of fire.*—All other factors being equal, batteries which have a high rate of fire will be able to bring effective fire to bear upon a given target in less time than batteries having a low rate of fire. Such batteries will be able to adjust fire easily and rapidly, for there will be many shots falling in a short period of time.

(2) *Range to the target.*—Regardless of the system of fire

control, the greater the range to the target, the less the accuracy of fire. When ranging is accomplished only by estimation, this effect is magnified. It is imperative that, whenever an alternate method must be used, the battery hold fire until the range is as unfavorable to the enemy as possible.

(3) *Speed and maneuverability of the enemy.*—Modern warships of all sizes are capable of high speeds and considerable maneuverability. They are also able to fire effectively when maneuvering. Adjustments should be influenced by any observed movement of the target. For instance, there is a well-known tendency for most naval vessels under fire to head for the last splash, knowing that the shore battery will adjust fire based on that splash. This maneuver will cause succeeding shots to fall in the opposite direction and sense. The battery commander must look for such tactics and, if the situation warrants, avoid applying a correction that may appear necessary at the moment.

(4) *Spotting.*—It is almost certain that when a battery uses an alternate method, the range spotting will be by sensing from an axial station, possibly with the naked eye or no instrument other than field glasses. There are at least two important factors which will limit the accuracy of range spotting; first, whether or not the shots fall in line with the target; and second, the height of site of the spotting station. To insure correct range spotting, it is important that correct lateral adjustment be obtained first. Naturally, the higher the station, the easier the spotting. For spotting from gun levels at or near sea level, the maximum range for effective visual spotting is about 6,500 yards. This figure will be reduced by poor conditions of visibility. It can be increased by adding height of site.

(5) *Types of fire.*—Under normal conditions, adjustment of fire is made to bring the center of impact onto the target and keep it there. However, for some conditions and for *rapid fire guns only*, it may be advisable to depart from standard methods. The following method is applicable only for a target pursuing an incoming or outgoing course, and when it is difficult to estimate accurately the range and rate of change of range. The method is devised to eliminate the necessity for knowledge of accurate ranges and rates of change of

range. An incoming target is taken as an example. Fire is opened at the best known value of the range. The fall of shots is adjusted until a correct deflection and a fair idea of the range to hit the target are obtained. The deflection is kept accurately adjusted, but the range is adjusted to be somewhat short of the target's present position and held there. Fire is continuous. If the target continues its incoming course, it is likely to run into the fall of shots, provided the deflections are accurate. The range adjustment should not be made too far short, because that will give the enemy time to figure out the situation and change his course. When the vessel has come short of the range at which the gun is being fired the elevation is reduced so that the gun is again firing short. As pointed out before, this method will be successful only for rapid fire guns.

(6) *Training*.—Seacoast units in combat have experienced bombardment that has partially or completely reduced the communications of shore installations before the enemy has been engaged. Unless a battery has been trained to function under such conditions, its effectiveness is negligible. The effectiveness of a battery which is measured in hits-per-gunner-per-minute, is a direct function of the state of training of the unit, and its readiness to operate under all possible conditions. Too many units do all their drilling on the standard fire control systems, and then discover that they will not be able to use that system when the time of combat comes. Training should be realistic and thorough. Night firing should receive as much if not more attention than day firing. The expectancy of attack at night is considerable, particularly for those batteries expecting to engage motor torpedo boats.

SECTION II

ONE-STATION FIRE CONTROL SYSTEM

■ 166. *GENERAL*.—*a. Purpose*.—The one-station fire control system was devised to permit the delivery of effective fire, using case III pointing, on a moving target by either a two- or a four-gun battery when its range finding element has been rendered inoperative. When a battery's range finding element breaks down, and case II pointing is possible, a shift

to central control, discussed in this chapter, should be made in preference to the one-station fire control method. Under service conditions, the use of this system would be indicated when single station range finder data are not available or when data from one or both stations of a horizontal base system are lost because of casualties, failure of communications, or lowered visibility. Future position data (that is, data for the set-forward point) can be determined either on the plotting board or on a range-time chart.

b. Limitations.—It is limited to ranges at which range sensings (overs and shorts) can be spotted from a station near the battery. This limiting range will vary with the battery situation, being influenced by the height of site of available points of observation and atmospheric conditions. Furthermore, this system of fire control is predicated upon a rectilinear, constant speed course, whereas in combat such obliging tactics on the part of the enemy cannot be expected. The system can be adapted to a maneuvering course, but thorough familiarity with the basic rules is necessary before such adaptation can be attempted. For these reasons, the following discussion deals with the rules and their application to a rectilinear course, after which the problem of a maneuvering target will be treated.

c. Minimum requirements for operations.—One observation station, located near the battery, is required. From this station, the range and course of the target are estimated, present azimuths are measured, and the lateral deviations and range sensings are obtained. This station must have one instrument for observation of target azimuths. Two additional azimuth instruments for spotting lateral deviations and range sensings are desirable. Local communication between this station and the plotting room is necessary for the transmission of azimuth readings. A second line, if available, should be used for intelligence, command, and spotting. In the system developed here, the normal plotting room instruments are used, with the exception of the spotting board and range fire adjustment board. The time interval system should be used; if it has been rendered inoperative by accident, a local substitute can be improvised. Firing data are sent to the guns by the best method available.

■ 167. PROCEDURE.—*a. Definitions.*—In order to clarify the discussion that follows, it is desirable that the meaning of the following terms be understood:

(1) *Ballistic area.*—The intervening space lying between the impacts of two salvos, one of which consists of all overs and the other of all shorts.

(2) *Ballistic course.*—An assumed course which is a line drawn through two or more ballistic areas or points.

(3) *Ballistic point.*—A point where a hit or a mixed salvo was obtained.

(4) *Fire for effect.*—Fire conducted at full rate with two guns as soon as a 500-yard ballistic area has been established.

(5) *Ranging fire.*—Ranging fire is used to locate the target in a 500-yard ballistic area.

(6) *Searching up (down).*—Arbitrarily increasing (decreasing) successive ranges to the assumed target location in order to bracket the target.

b. Procedure.—(1) *Initial estimate of range and course of target.*—The observer at his station, after identifying the target, will observe its course carefully and estimate the range as accurately as possible. The direction of the course is estimated by pointing the telescope in the direction the target is traveling, so that the telescope and the course are as nearly parallel as possible. The direction of the course may then be taken as the azimuth reading of the instrument. If the target was being tracked when the change over to this method was made, prediction would be continued on the course already plotted.

(2) *Use of plotting board.*—Only the gun arm of the plotting board is used (the relocating arm of the M1923 and M1 boards). After the estimated course and range to the target are reported to the plotting room the command TRACK is given and the observer tracks the target, azimuths being sent in the usual manner and set by the arm setter. The plotter draws an "estimated course" based on the initial estimated data, and the assistant plotter draws a "false course" parallel to the estimated course near the circumference of the board. The gun arm having been set at the observed azimuth to the target, the assistant plotter marks the intersection of the gun arm and the false course. A number of such points are

plotted, enabling the assistant plotter to predict the azimuth of the set-forward point on the false course. The gun arm is then brought to this set-forward point. The plotter plots the future position of the target at the intersection of the gun arm and the estimated course and reads the range to this point. This range is correct ballistically, and the corrected range or elevation is sent to the guns. The arm setter reads the azimuth to this point. This is corrected ballistically in the usual manner and the corrected azimuth is sent to the guns.

(3) *Ranging fire.*—One ranging salvo (two guns) is fired from data on the estimated course, and the resulting sensings are indicated on the plot. Lateral adjustment is accomplished in the prescribed manner (see par. 154*d*). Ranging fire is continued by individually ordered salvos, the plotter increasing or decreasing the range by 1,000-yard differences until a 1,000-yard ballistic area or a ballistic point is obtained. If a 1,000-yard ballistic area is obtained, a ranging salvo is fired at the range representing the midpoint of the ballistic area. If the shots of this salvo all fall in the same sense, either all overs or all shorts, the target has been located in a 500-yard ballistic area. When either a 500-yard ballistic area or a ballistic point has been obtained, ranging fire has been completed.

(4) *Fire for effect.*—(a) Fire for effect begins at full rate of fire, using two guns, immediately upon completion of ranging fire. The plotter draws a new course through the ballistic point or through the center of the 500-yard ballistic area obtained in ranging fire. This course must be parallel to the original estimated course, since there is no information as yet upon which to base a change in direction. Prediction is made along the estimated course and each set-forward point is plotted as described in (2) above. As each salvo is fired, the range officer marks the point corresponding to the firing data for that salvo by drawing a small circle around the point. Some time will necessarily elapse between the plotting of a point and the receipt of the sensings of the shots fired on data obtained from the point. Therefore, strict attention must be given to the correct marking of the sensings beside the proper circles on the course.

(b) If the shots of the first salvo of fire for effect fall in the same sense the plotter immediately searches in the proper direction until a ballistic point or a ballistic area is obtained. The range change employed during the searching process must be sufficiently large to insure bracketing the target regardless of its speed and direction. The maximum searching increment then is governed by the maximum speed of the target and the length of the predicting interval. For general use with a 20 second predicting interval the following increments are recommended; first, 150 yards, then 300 yards, then a succession of 600-yard increments until a ballistic area or a ballistic point is obtained at which time a ballistic course is drawn through the new ballistic area or point and the previous ballistic area or point. A "relay" can usually be sent to the guns in time to save the ammunition which would otherwise be fired on data obtained from the last point plotted during searching.

(c) Fire for effect is continued on the new ballistic course and searching is begun immediately if the shots of the first salvo are reported in the same sense. If a ballistic point is obtained on an already established ballistic course searching should not be begun until all shots of two successive salvos are reported in the same sense.

(d) When the ballistic course contains four ballistic points or areas and a ballistic point has been obtained on the ballistic course, battery salvos should be ordered. If the fall of shots indicates that the ballistic course is incorrect, searching is begun using two-gun salvos. Each change in the direction of the ballistic course must be accompanied by a change in the direction of the false course. The assistant plotter will maintain his false course as nearly as possible parallel to the ballistic course.

■ 168. ILLUSTRATIVE EXAMPLES.—*a. Example No. 1.*—(1) *Situation.*—A certain battery is equipped with four 155-mm guns, sited for case III firing. The firing interval is 20 seconds. An observer stationed near the directing point is reading azimuths to the target every 20 seconds on the TI system. The dead time is 40 seconds with the data going to the guns 30 seconds after the azimuth observation on which it is based. The approximate time of flight is 30

seconds. By the time the fall of a salvo has been received and plotted there will normally be one salvo in the air and data for one more salvo will have been sent to the guns. Therefore, in searching after a ballistic area or point has been established, the salvo already in the air will be wasted, but the one still in the gun can be saved by ordering, "Re-lay." In order that information relative to the fall of the shots may be marked quickly on the plotting board, symbols listed in figure 146 are used.

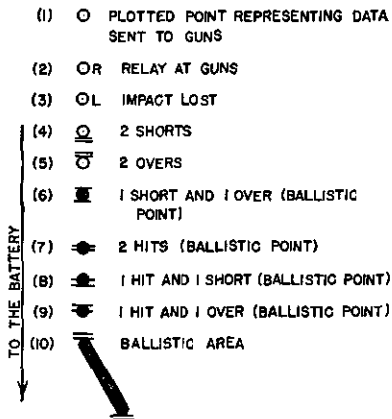

NOTE: SYMBOLS (6), (7), (8), (9), AND (10)
ESTABLISH THE BALLISTIC COURSE

FIGURE 146.—Symbols for plotting board—one-station fire control method.

(2) *Explanation.*—(a) Figure 147 shows a typical course as developed on the plotting board by using one-station fire control. Salvo 1 is fired at an estimated range of 12,000 yards and is observed over. Salvo 2 is fired at a range of 11,000 yards or down 1,000 yards and is observed short; the range is increased by one-half the distance between salvos 1 and 2, and salvo 3 is ordered at 11,500 yards. When salvo 3 is sensed as over, a 500-yard ballistic area is established between salvos 2 and 3.

(b) A course parallel to the estimated course is drawn through the center of the ballistic area. Fire for effect is

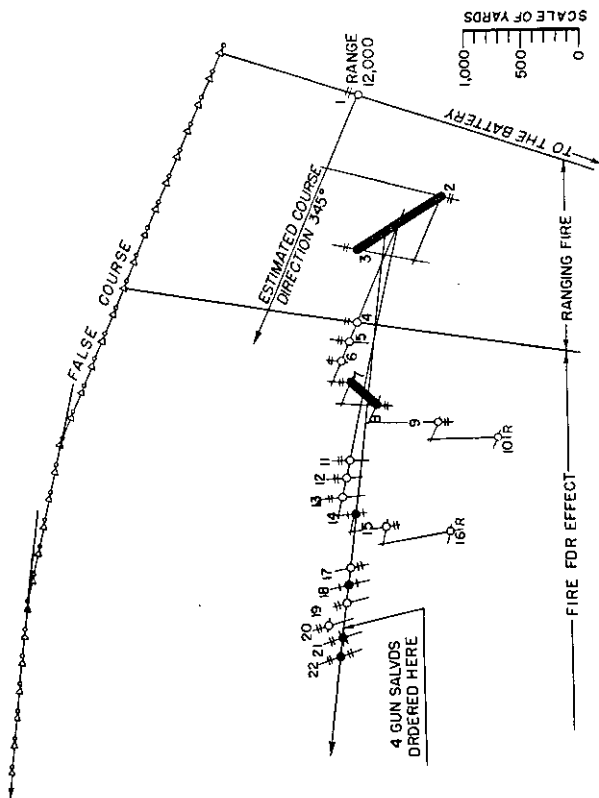

Figure 147.—Typical course—using one-station fire control.

begun by sending the data for point 4 to the guns. Points 5 and 6 are plotted on this course. When 6 has been plotted, sensings for 4 are reported as "over-over"; therefore, searching down is begun by decreasing the range 150 yards to point 7. After 7 is plotted, the sensing of 5 is reported as "over-over" so that the range is decreased 300 yards to point 8. When 6 is sensed as "over-over," the range is decreased 600 yards to point 9. Point 7 is reported as "over-over," and again the range is decreased 600 yards to point 10. The sensing of point 8 as "short-short" is received in time to order, "Re-lay," on data for point 10. The shots fired with data for point 7 were reported as "over-over," and the shots fired with data for point 8 were reported as "short-short," so a ballistic area has been established. A course is drawn through the midpoints of the two ballistic areas and data for 11 are sent to the guns. Points 12 and 13 are plotted on the same course. After 13 has been plotted, the sensing for 11 is reported as "over-over," so searching down is begun by decreasing the range 150 yards. Point 12 is sensed as "over-over," so the range for 15 is decreased 300 yards. Point 13 is now sensed as "over-over," so an additional decrease of 600 yards is allowed for 16. The sensing of 14 as a ballistic point is received in time to order, "Re-lay," on 16. A ballistic course is now drawn through this ballistic point and the two ballistic areas now on the plotting board. Points 17, 18, and 19 are plotted on this new course. After 19 is plotted, the sensing of 17 is received as "short-short." Searching up is begun by increasing the range 150 yards for point 20. However, when the sensing of point 18 produces a ballistic point, point 21 is brought back on the ballistic course, and since there are four ballistic areas or points on the course, four-gun salvos are ordered at this point. When the sensing of the salvo fired on data for 19 is reported as "over-over," searching is not attempted; after a ballistic point has been obtained on a ballistic course, searching is not justified until all the shots of two consecutive salvos are reported in the same sense. Firing should continue on the present ballistic course until two consecutive salvos fall in the same sense, in which case two-gun salvos should be ordered and searching in the proper direction should begin.

b. *Example No. 2.*—Refer to figure 148 for illustration of the following example: Salvo 1 is fired at the estimated range of 7,000 yards and is found to be short. Salvo 2 is fired at a range of 8,000 yards or up 1,000 yards. When this is sensed as "over-over," the range is reduced by one-half the distance between 1 and 2, and salvo 3 is ordered at 7,500 yards, establishing a 500-yard ballistic area between 1 and 3, when salvo 3 is sensed as "over-over." A course is now drawn through the center of the ballistic area parallel to the estimated course. Salvos 4, 5, and 6 are plotted along this course. After 6 is plotted, 4 is sensed as "short-short." Searching up is begun by increasing the range 150 yards for point 7. When 5 is sensed as "short-short," an additional up correction of 300 yards is ordered for 8. When 6 is sensed as "short-short," an additional up correction of 600 yards is ordered for 9. The sensing of 7 as "hit-short," establishing a ballistic point, is received in time to order, "Re-lay," for salvo 9. A new ballistic course is now drawn through the center of the first ballistic area and point 7. Salvos 10, 11, and 12 are plotted on this course. After 12 is plotted, 10 is established as a ballistic point. No searching is ordered until both 11 and 12 are sensed as "over-over," (two successive salvos, both over or both short, are needed to disprove a ballistic course upon which a ballistic point has been obtained). As 11 and 12 were sensed as "over-over," a down correction of 150 yards is ordered for 15. After 15 has been plotted, 13 is sensed "over-over"; therefore, an additional down correction of 300 yards is ordered for 16. Since 14 is also "over-over," the range is reduced by 600 yards for 17. Since 15 is sensed as "over-over," an additional correction of 600 yards is ordered for 18. The sensing of 16 as "short-short," establishing a ballistic area between 15 and 16, is received in time to order, "Re-lay," for 18. The ballistic course is established through the four ballistic points or areas, and points 19, 20, and 21 are predicted on this course. When point 21 is plotted, point 19 is sensed as "hit-hit." The course which was drawn through the four ballistic points and areas has been confirmed by the sensing of this ballistic point on the course. Four gun salvos are now ordered for 22. Four gun salvos will be continued until all shots of two successive salvos are reported in the

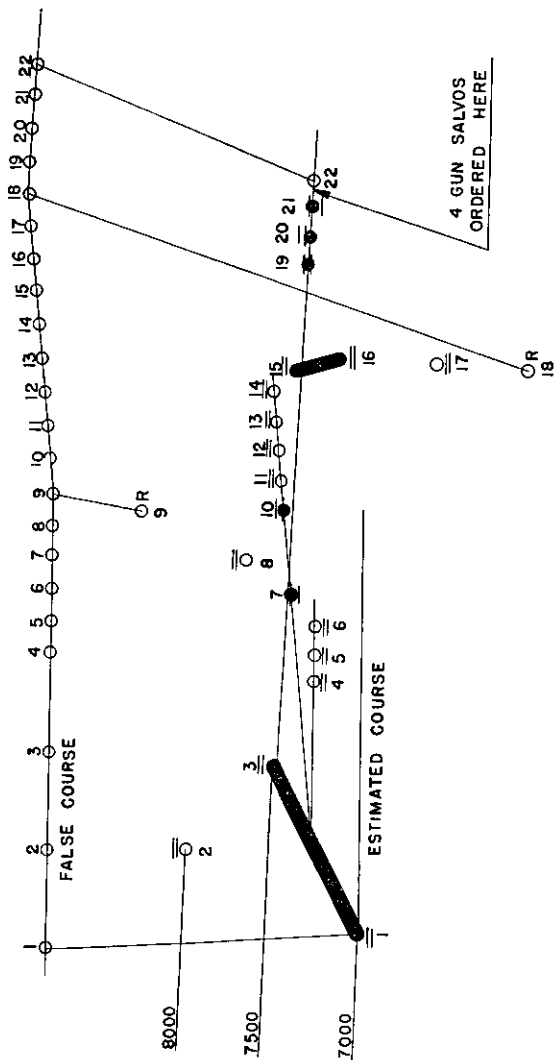

FIGURE 148.—Example of one-station fire control method course.

same sense; at this time two gun salvos will be ordered and searching will begin in the proper direction.

■ 169. TRAINING.—*a.* Training in plotting board procedure can be obtained with the aid of hypothetical courses. Such courses are constructed as follows:

(1) Assume a path of the target on the plotting board and draw rays every $\frac{1}{2}^\circ$ to intersect it.

(2) With the dispersion tape and scale (see FM 4-10) plot each impact of a two-gun salvo on each ray.

(3) Connect the plotted impacts of shots from each gun, forming two zig-zag lines and making each line of a width to represent the actual danger space (see FM 4-10) for the target.

b. The hypothetical course is placed on the plotting board on one side of the center line of the field of fire, while the ballistic course is developed on the other side. There should be a difference of some convenient number of degrees between the two courses, such as one quadrant on the 110° plotting board or 100° on the M1923 (Cloke) board. When a range and an azimuth are obtained from the ballistic course, the constant angular difference is applied to the azimuth and the point is plotted on the hypothetical course. If the point plots short of the zig-zag lines, the spot is "short-short"; if over, it is reported as "over-over." If it falls between the two lines the salvo consists of one over and one short. If the point at any time falls upon a line a hit is reported. Lateral movement of the target can be simulated by assuming a constant angular speed such as 0.5° for each observing interval. By using the principles of the one-station fire control system, the hypothetical course is developed as a ballistic course on the plotting board in the same manner as the ballistic course of an actual target would be developed.

■ 170. SUMMARY OF RULES FOR ONE-STATION METHOD.—Rules for fire adjustment applicable to standard systems of fire control are contained in FM 4-10. The following rules are applicable to this system only:

a. Enter fire for effect by assuming a course parallel to the estimated course and passing through either the ballistic point or the middle of the 500-yard ballistic area established by ranging fire.

b. Continue firing on an assumed course until the fall of shots indicates that it is not correct.

c. If at any time the fall of shots indicates that the course being fired on is not correct, begin searching in the proper direction.

d. An incorrect course is indicated when—

(1) All shots of the *first salvo* fall in the same sense; or

(2) After a ballistic point is established on a ballistic course, *two consecutive salvos* fall in the same sense.

e. When a ballistic area or point is located while searching, re-lay and resume firing on a new ballistic course through that area or point.

f. Adjust laterally by the standard method for the battery. It is important that impacts fall on or very close to the battery-target line at all times so that they can be sensed for range.

■ 171. APPLICATION OF ONE-STATION RULES TO MANEUVERING

COURSE.—a. The foregoing rules were developed on the basis of a rectilinear, constant-speed course. They can be adapted, however, to maneuvering targets, provided any perceptible target maneuver is reported immediately. To accomplish this, training of personnel is the critical factor. Observers should be schooled in estimating target angles and changes in bearing, checking their estimations against the plotting board.

b. When a target maneuver is discerned, the plotter should be notified immediately and provided with as accurate an estimate of the target angle and new bearing as possible. Since the normal tactical radius of turn of a naval vessel is approximately 500 yards, the plotter can draw a curve of this radius tangent to his current course. Target set-forward positions can be plotted on the curve in the direction of the announced bearing. Since any change in rudder causes a reduction in speed, the plotter must adjust the rate of change in range.

c. Searching can be conducted in the prescribed manner should the estimated maneuver be unverified by a ballistic point or area. When the target angle becomes considerably acute, it is recommended that the normal searching incre-

ments be doubled. Although the number of ballistic points to be expected while the enemy is turning is relatively small, the normal expectations of the system should be realized when the maneuver is completed. Naval vessels will not normally travel a sinuous course while on an offensive mission, although considerable maneuvering must be anticipated, particularly when the vessel is being fired upon by shore installations.

SECTION III

MODIFIED ONE-STATION METHOD USING TIME-RANGE BOARD

■ 172. MODIFIED ONE-STATION METHOD.—*a. General.*—The method described in this section is a modification of the

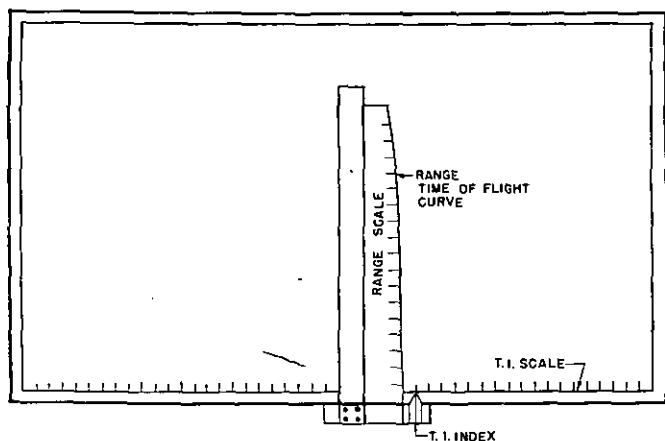

FIGURE 149.—Time range T-square in use.

method described in section II and may be used for case II or case III pointing. The equipment needed can be improvised locally and kept at the battery command post for use in case the plotting room is destroyed.

b. Procedure.—This method consists of plotting predicted ranges against time, establishing a time-range curve and

predicting along this curve. Ballistic areas and ballistic points (see par. 167) are determined on the curve and are used to establish the position and direction of the time-range curve. The equipment needed is a drawing board (or table) with a true edge, a T-square to which a special scale is attached, and a piece of drawing paper. The scale on the T-square is a curved range scale. This curve is a plot of time of flight against ranges and is good for only one combination of powder, projectile, and gun. (See fig. 150.) The paper is fastened to the drawing board and a uniform scale is placed along the bottom to represent the elapsed time between TI bells. The time scale is the same as that used in plotting the range scale curve. The graduations are spaced at intervals corresponding to the observing interval used.

(1) *Operation.*—The T-square is hooked over the bottom of the board and positioned so that the index on the head coincides with the TI graduation at the extreme right of the board. A point is plotted at the estimated range to the target and ranging fire is begun. The TI graduation is considered to correspond to the time of observation in the ordinary position finding method. The T-square is moved to the left one interval at each TI bell. The graduation corresponding to the particular interval should be checked with a pencil mark (✓) as the bell rings. If the shots of the first ranging salvo are reported in the same sense, a second ranging salvo with a difference in range of 1,000 yards is fired. As explained in paragraph 167b(3), this is continued and a 1,000-yard ballistic area is established. A salvo is fired at the range corresponding to the midpoint of this 1,000-yard ballistic area and a 500-yard ballistic area is established. The time-range curve is now plotted through the midpoint of this last ballistic area in a direction corresponding to the estimated rate of range change.

(2) *Estimation of rate of change in range.*—The rate of change in range will depend upon the speed and direction of the target. Once the target has been identified, its speed can be estimated in miles per hour and converted into yards per second by the formula,

$$\text{yards per second} = \frac{\text{miles per hour.}}{2}$$

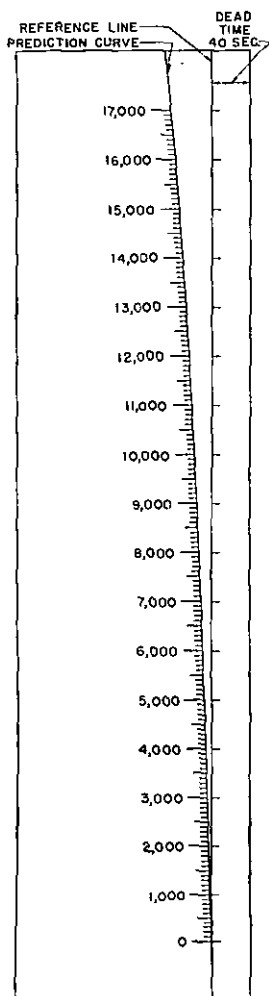

FIGURE 150.—Range time of flight scale curve.

The rate of change of range can be determined by multiplying the speed in yards per second by the appropriate factor in the following table.

Target angle between (degrees)	Factor	Target angle between (degrees)	Factor
0-18	1.0	58-63	0.5
19-32	.9	64-70	.4
33-41	.8	71-75	.3
42-49	.7	76-81	.2
50-57	.6	82-87	.1

Since the estimates of the target angle and the target speed are at best very rough, precision in the use of the above table is unnecessary. In estimating the speed of the target, consideration should be given to the type of ship, its apparent mission, and whether or not it is traveling in a convoy with other ships that would control its speed. The slope of the time-range curve is a function of the rate of change of range. To save time it will be convenient to prepare a series of charts showing the slopes corresponding to various rates of change in range. A chart can be prepared for each factor shown in the preceding table. Such a chart is shown in figure 151. This chart contains a series of straight lines, each one corresponding to a certain rate of change. The slope of any line is determined by a triangle, the vertical leg of which is the change in range during the observing interval, the horizontal leg of which is proportional to the time. This slope is equal to the change in range divided by the change in time. The charts should be on transparent material so they can be used for both increasing and decreasing ranges.

If the proper chart is placed on the board so that the horizontal leg of the chart is parallel to the lower edge of the board, the estimated slope can be drawn on the board parallel to the selected line on the chart. As soon as the estimated direction of the curve is drawn through the midpoint of the 500-yard ballistic area, the battery opens fire with two-gun salvos at ranges predicted along this estimated curve. Predicted ranges are obtained in the following manner: the

T-square is brought up until its index coincides with the proper TI graduation. The intersection of the time-range curve with the range scale is read and plotted. Searching is accomplished in the same manner as described for the plotting board along the range scale in steps of 150, 300, or 600 yards. Sensings are plotted in the same manner and ballistic areas and ballistic points are used to correct the estimated direction and position of the time-range curve on the paper.

TARGET ANGLE BETWEEN 0° - 18°

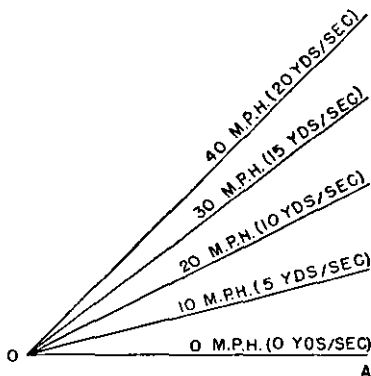

FIGURE 151.—Slopes corresponding to rates of change in range.

(3) *Deflections and lateral adjustment, case II.*—For case II firing, deflections and lateral adjustment corrections are determined as explained in paragraph 174*d*.

(4) *Azimuth and lateral adjustment, case III.*—For case III firing, azimuths are obtained as follows: With an azimuth instrument set up as close to the battery as practicable, the azimuth to the target is read at each TI bell. The time interval bell corresponds to the one used in setting the T-square on the time-range board. The successive azimuths are plotted on a uniformly graduated azimuth tape similar to that used on the universal deflection board (see par. 97*b*). By means of a prediction scale (standard or improvised), the change in azimuth is measured in prediction scale units. By means of a set-forward slide rule, the scale distance to the set-forward point azimuth is obtained and plotted on the tape

and the corresponding azimuth is corrected and sent to the guns. When a deflection board is not available, the ballistic correction would naturally have to be included in the adjustment correction. If the parallax due to displacement of the azimuth instrument is large, an azimuth difference chart may be used. If small, the correction for parallax can also be taken care of by adjustment. Hence the azimuth instrument should be near the guns if possible. Lateral adjustment is the same as for case II.

SECTION IV

CENTRAL CONTROL

■ 173. PURPOSE.—*a.* The purpose of this section is to impress the battery commander with the critical necessity of being prepared to conduct fire when the standard position finding and fire control system of his battery becomes inoperative, and to offer a solution to the gunnery and fire control problem involved under these conditions. The problem resolves itself into two phases: the ability of the battery to open fire and continue fire under central control, and the ability of the battery to revert, during firing, to central control in the event of failure of the methods used in opening fire.

b. It is assumed in the first condition that action is commenced before the battery's standard system has been installed, or a break-down of the system has occurred before the enemy is engaged. Combat experiences of seacoast units clearly indicate the strong possibility of these conditions obtaining.

■ 174. PROCEDURE.—*a.* The procedure offered as a solution presupposes that conditions of visibility and emplacement are of such a nature as to permit the use of case II pointing. The possibilities of error when attempting to employ case III in such an emergency situation are large, and pointing in this manner is hardly practicable in central control, under which condition it is assumed that communications with the plotting room are out. However, if a depression position finder or an azimuth instrument were available, present azimuths could be obtained from an observation post from which the enemy vessel was visible. The azimuths could be cor-

rected for wind, drift, angular travel during the time of flight plus dead time, and displacement of the observation post from the battery directing point and corrected azimuths transmitted to the guns. Without plotting room equipment, however, this method of attempting case III does not merit further discussion here, and it should not be attempted unless the siting of the guns makes case II pointing impossible.

b. In batteries not equipped with auxiliary range-finding instruments, such as a depression position finder or self-contained range finder, the battery commander must make an initial estimate of the range to the enemy. Considerable practice in range estimation by the officers and noncommissioned officers of the battery is essential, checking their estimations against the battery's standard range-finding system. In many situations range estimation may be accomplished by rapid comparison with reference points in the water area such as navigation aids or buoys. If possible, buoys may be anchored at known ranges from the battery. Other situations will require the problem to be one of unaided estimation.

c. The range estimate should be as accurate as possible. However, if the opinion of the individual making the estimates wavers between two ranges, which differ by a sizeable amount, the smaller of the two estimates should be used. Opening short will facilitate initial spotting, in addition to being more disconcerting to the enemy and providing a change for ricochet hits.

d. An initial range to the enemy having been estimated, the battery commander, who must make his estimations and adjustments in terms of the units used in graduating the range or elevation disks on his guns, determines the proper setting for this range to lay the guns in elevation and transmits this information to the guns. An approximate initial deflection can be determined by tracking the target during the time of flight for the estimated range. For instruments having splash scales, the travel should be read on that scale without traversing the telescope, and the scale reading converted to the proper deflection setting for application on the gun sights.

e. Firing should be conducted by battery or platoon salvo. Assuming prior calibration, adjustments in range and deflec-

tion, can more easily be determined and ordered by the battery commander if firing is conducted in this manner. Either the battery executive officer or chiefs of sections can order the guns to be fired when they are loaded, pointed, and ready. Full rate of fire should be employed.

f. Accurate spotting of overs and shorts from the battery commander's station is important, and rapid and early adjustment in deflection must be accomplished before accurate range sensing is possible. Adjustment is based on the principle of laying down a series or a ladder of shots increasing or decreasing successively in range from the estimated range until the target has been located within a bracket. Firing is commenced at full rate at the estimated range and as soon as the first splash is sensed, a ladder should be started immediately in the direction of the enemy. In order to accomplish adjustment onto the target as rapidly as possible, range adjustments should be bold, no less than a dispersion ladder (two forks) in magnitude until the target is crossed. However, when the range is comparatively great and the accuracy of estimation poor, range changes greater than two forks are necessary. Such cases may require change of four to eight forks until the target is bracketed. The magnitude of the fork in terms of yards varies as the range. For example, with a 155-mm gun M1918M1, firing shell M101, fuze PD M51, supercharge, the value of the fork at 5,000 yards is 60 yards, while at 10,000 yards it is 104 yards. At short ranges the accuracy of estimation is considerably better than at the more extreme ranges. It is improbable that an estimation of range at 10,000 yards would be sufficiently close to make two forks (in this case 208 yards) a bold enough change to secure rapid adjustment. A change of four forks in this case would be 416 yards, and eight forks 832 yards. Neither would constitute too radical a range change if the initial estimate was approximate. When the target is bracketed, the ladder should be reversed, halving the adjustments used initially, until the target is included in a one-fork bracket. Fire is continued within the bracket until a new correction is indicated by the fall of shots. It is necessary that a running record of firing elevations ordered and sensings obtained with these elevations be maintained at the battery com-

mander's station and be readily accessible to him. A member of the battery commander's detail can be trained to keep such a record. In this way, a record of the trend or rate of change of elevations can be determined, providing the battery commander with information upon which to base his corrections during firing. It must be anticipated that the enemy will maneuver or alter his speed when fired on, and the probability of his maneuvering toward the most recent splash from the battery must be borne in mind to avoid possible over-adjustment.

g. Good adjustment in deflection is a prerequisite to accurate range sensing. Mention has been made of an approximate means whereby an initial deflection may be determined. Adjustment in deflection is most satisfactorily performed at the battery commander's station, spotting with whatever instrument is available for such a purpose. The battery commander can determine and order such adjustments as he deems necessary to place his guns on the enemy in deflection.

h. The second phase of the problem mentioned in paragraph 173a is training a battery to *continue* fire when standard systems are disrupted. Efficiency of operation under either contingency requires intensive training. Little time should be lost in shifting from one fire control procedure to another when one system suddenly becomes inoperative. This will necessitate all battery personnel being thoroughly familiar with the battery's standing operating procedure, which should be designed with a view to simplicity and clarity.

Example: Assume that a 155-mm gun battery normally employs the horizontal base system of position finding. The battery commander has designated, in the standard operating procedure, that the horizontal base system of position finding, using case II pointing, will be known as "condition A, case II," and when case III pointing is employed, as "condition A, case III." Central control and gun commander's control are "condition F" and "condition G" respectively. Preparing an SOP in this manner will greatly facilitate shifting during action or prior to action to another method of fire control. The shift can be accomplished by merely

informing the concerned elements of the battery "condition Able, case II," or "condition Fox." All personnel must be thoroughly trained in the role they are to play under the several conditions.

i. During action, central control should be commenced at the first indication of disrupted communications with the plotting room. No time should be lost in attempting to trace the source of trouble before resumption of fire. Good adjustment on the enemy may have been accomplished prior to the break-down, and for this reason firing should be resumed as rapidly as possible. The battery commander should immediately ascertain from the guns the last elevation at which the guns were fired and order firing resumed, commencing his record of transmitted elevations and observed range sensings. Such adjustments in range and deflection as are necessary should be ordered by the battery commander and transmitted directly to the guns. If the cause of trouble is determined and corrected, whether or not to shift back to the standard method is at the discretion of the battery commander. The effectiveness of fire being produced will probably influence his decision. However, even though destructive fire is being delivered upon the current target, a reassignment of the battery to a new target at a different range will necessitate another search in range.

SECTION V

GUN COMMANDER'S CONTROL

■ 175. GENERAL.—*a.* Some seacoast units have been obliged to open fire using gun commander's control. Shelling from enemy naval craft and bombing by hostile aviation disrupted all intrabattery communications and those to higher echelons before the enemy came within effective range of the shore installation. These experiences clearly indicate the necessity for training the chiefs of sections and gun commanders in the conduct of fire. Again it is emphasized that the mission of a battery is not to be abandoned as long as personnel, guns, and ammunition are available.

b. In batteries having four guns, all the guns should be kept under one station control (as outlined in the previous section) as long as possible. When this centralized control

breaks down, the battery, if possible, should operate under the control of section leaders with two guns to each section. If section control breaks down individual gun commanders should assume control. In the latter case, it will simplify the control of the guns if each gun engages a separate target whenever possible.

c. If using gun commander's control, the decision as to when to open fire is determined largely by the apparent mission of the enemy. Fire is generally withheld when the enemy's mission is clearly a reconnaissance or feint, but if the enemy is within range of seacoast armament, and is shelling shore installations or is engaged in mine sweeping or mine laying, he should be engaged, regardless of the methods available. It must be remembered, however, that the greater the range, the less the accuracy of fire especially at low heights of site. Therefore, when a battery is employing an alternate method, particularly gun commander's control, fire should be withheld until the range is as unfavorable to the enemy as possible.

■ 176. PROCEDURE.—Initial estimation of the enemy's range is accomplished by means similar to those described under central control. The persons responsible for the conduct of fire should be well trained in range estimating and know the value of the fork and the change in elevation for each 100 yards change in range for various ranges. A ladder is started toward the enemy by changing the range with adjustments of at least two forks or greater if the range is extreme and the estimation rough. The ladder is reversed when the target is bracketed and previous adjustments are halved until the enemy is included in a one-fork bracket. Fire is delivered within the bracket until the fall of shots warrants further correction. The responsibility for lateral adjustments should be on some one other than the gun pointer. However, if this method fails and if the time of flight is less than the firing interval of the guns, lateral adjustment can be performed by the gun pointers "jumping splashes." Jumping splashes should be considered only as a last resort. Numerous difficulties are imposed on the gun pointers by this method, such as the difficulty of identifying their own splashes, particularly at full rate of fire, but the system is adequate if other means fail.

SECTION VI

TEMPORARY AND STAND-BY FIRE CONTROL SYSTEM
FOR 90-MM AMTB BATTERIES

■ 177. PURPOSE.—A stand-by fire control system should be available in 90-mm AMTB (antimotor torpedo boats) batteries, for use in the event of failure of the standard system. The stand-by system will also be used as a temporary fire control system, pending the availability of the standard fire control equipment. The purpose of this section is to describe the operation of stand-by fire control systems for 90-mm AMTB batteries.

■ 178. THE PROBLEM.—*a.* Before considering the fire control system necessary for 90-mm AMTB batteries, the characteristics and tactics of motor torpedo boats should be understood. Motor torpedo boats are usually from 60 to 100 feet long. They have a narrow beam, shallow draft, and low silhouette (about 10 feet above the water line). They are capable of speeds up to 50 knots (60 mph) and can negotiate intricate turns. They are usually unarmored and only lightly armed, except for torpedoes.

b. A motor torpedo boat attack will probably occur at night or during periods of poor visibility. The boats will run at a slow speed using underwater exhaust for silence. The idea that such craft will use high speed to enter a harbor, hit, and then leave seems improbable. Rather, it is believed that they will rely upon stealth to enter unobserved, maintaining silence until their mission is completed, and then use their speed for escape. However, the possibility of a rapid entrance must not be discarded. The attack will take the form of a raid into a harbor to sink anchored shipping. Six to twelve craft can be expected to operate together.

■ 179. FIRE CONTROL SYSTEMS.—*a.* To meet the problem the rapid transmission of initial firing data to the guns and the frequent change of subsequent data are of primary importance. Consequently, the temporary fire control system, which must utilize available equipment, must be based on simplicity and speed. Possible range finding systems which a battery may use (equipment being available) are as follows:

- (1) Radar.
- (2) Self-contained range finder.
- (3) Depression position finder, if a suitable height of site can be obtained close to the battery.
- (4) Horizontal base.
- (5) Estimation, using available or installed reference points.

b. The single-station systems are employed in the normal manner. The horizontal base system should have two short base lines to insure full coverage of the field of fire. Range determination by estimation should rely on comparison with the recorded ranges to reference points and marking buoys already existing in the field of fire or provided specially for the purpose.

TABULATION OF ADVANTAGES OF RANGE FINDING SYSTEMS

Advantages	Self-contained range finder	Radar	Depression position finder	Horizontal base	Estimation
1. Accuracy.		X		X	
2. No difficulty getting range finding system on correct target since observer has same view of field of fire as BC station.	X	X	X		X
3. If range finding system is in or adjacent to BC station, fire direction can be by voice, permitting close control.	X	X	X		X
4. Continuous range readings.		X	X		
5. Ability to obtain initial range quickly.	X	X	X		X
6. Ability to change targets quickly.	X	X	X		X
7. Ability to operate at night or during periods of poor visibility at same efficiency as during daylight with excellent visibility.		X			
8. Ability to detect changes in course immediately.		X			
9. No vulnerable communication lines.	X	X	X		X

■ 180. FIRE CONTROL EQUIPMENT NEEDED.—*a.* Excepting when using the horizontal base system, the following fire control equipment is required when utilizing any of the range finding systems mentioned in the preceding paragraph:

(1) Range finder of the self-contained, radar, or depression position type.

(2) Two azimuth instruments for use as follows:

(*a*) One for range spotting.

(*b*) One for lateral spotting.

(3) One percentage corrector with range-elevation scale in mils (corrected for height of site) and an interpolator plate and tape.

(4) Communications with gun pointer and elevator setter.

(5) Bracketing adjustment chart.

(6) Lateral adjustment chart.

(7) Firing Tables 90-C-2.

b. If the horizontal base system is employed, the following additional equipment will be required:

(1) Three azimuth instruments, one for each of the three base-end stations: B^1 , B^2 , and B^3 .

(2) Time interval system (10-second interval).

(3) One plotting and relocating board M1923 (Clope).

■ 181. PREPARATION OF BALLISTIC CORRECTIONS.—When using a radar, self-contained range finder, depression position finder, or horizontal base position finding system, ballistic corrections must be prepared and used initially. The application of new ballistic corrections as the target changes position after fire is opened is not warranted and will unduly complicate the temporary fire control system. Precalculated ballistic corrections for opening fire should be available at all times. One method of accomplishing this is to divide the field of fire into sectors of about 30° and to subdivide these sectors in range every 3,000 yards, beginning with a minimum range of 3,000 yards. Ballistic corrections for meteorological conditions, and corrections for muzzle velocity, weight of projectile, drift, and displacement of the directing point should be calculated for the midpoint of each of the above subdivisions. Corrections should be computed in percent for range and in degrees and hundredths of a degree for deflection. These corrections can be recorded most con-

veniently by means of a chart (ballistic corrections chart) showing the subdivisions of the field of fire and should be recorded in reference numbers (see par. 163). The ballistic correction for opening fire may be taken readily from the above chart after the target has been located. Meteorological corrections may be excluded for ranges less than 3,000 yards. New ballistic corrections should be computed on receipt of each new meteorological message. The ballistic corrections may be computed from firing tables, or short cuts may be improvised by means of graphs.

■ 182. OPERATION OF SINGLE-STATION SYSTEM.—When a radar set, self-contained range finder, or depression position finder is available, the single-station system of fire control and position finding functions essentially as follows:

a. Ranges are obtained using the range finder available. In the case of a radar set or depression position finder the range data are continuous and may be read and set as frequently as desired. With a self-contained range finder, the frequency of readings depends on visibility, target definition, and range may be continuous if the visibility and target definition are excellent and the range is under approximately 5,000 yards; or it may be discontinuous, varying from 5- to 10-second intervals, if the visibility or target definition is less than excellent or the range over approximately 5,000 yards. Since predictions are not made during firing, the speed of a motor torpedo boat and its maneuverability necessitate the reduction of dead time to a minimum. Dead time should never exceed 5 or 6 seconds. Therefore, corrected elevations are required at the guns at least every 5 seconds, which means that range data from the range finder should be transmitted as frequently. In the case of a self-contained range finder, operating under adverse conditions of weather, target definition, or range, readings may be obtained at no less interval than 10 seconds, in which case the percentage corrector operator must use the interpolator to send out corrected elevations every 5 seconds.

b. An initial range correction for travel of the target during the time of flight plus the dead time may be obtained from the range finder readings. If radar is available, range readings are continuous and accurate and can be obtained in day-

light or darkness; therefore, unless available time indicates otherwise, an initial range correction for travel should be calculated. With a depression position finder, sited sufficiently high for accurate range determinations within the range of the armament and with sufficient visibility to permit accuracy, an initial range correction for travel should be calculated unless time dicates differently. With a self-contained range finder, range readings are not so reliable unless the operator is skilled and working under conditions favorable to the instrument; therefore, in some situations, especially when the time is not available to obtain range travel, it may be more advisable to neglect entirely a range correction for travel. To calculate a range correction for travel the change in range during 10 or 20 seconds is measured, the timing being done with a stop watch or time-interval system. The change in range during the measuring interval is the difference between the range finder data at the beginning and at the end of the interval. This change is converted into the proper range correction by dividing it by the measuring interval and multiplying the result by the time of flight plus the dead time. To obtain the time of flight plus dead time quickly, it is well to prepare a chart from the firing tables showing times of flight plus dead time for varying ranges within the limits of the armament. The range correction for travel is applied readily on the range percentage corrector by displacing the ballistic pointer the required amount on the range scale of the percentage corrector tape. For example, if it is calculated that the range will decrease 200 yards during the time of flight plus the dead time, the ballistic pointer should be moved minus 200 yards from its setting for the calculated ballistic correction while the present range is at the set index. This operation combines the range ballistic correction and the range correction for travel into one correction in percent, which correction is appropriate for opening fire. Once firing is begun the ballistic pointer should not be moved; all subsequent corrections for travel should be adjustment corrections as a result of observation of fire.

c. An initial lateral correction for travel is determined, using one of the azimuth instruments. An estimation of the lateral correction for travel is advisable only when the avail-

able time between observation of the target and opening of fire precludes the use of the azimuth instrument. The angular travel during a preselected measuring interval (usually 10 seconds) is determined by taking the difference between successive azimuth readings read at these intervals. It may also be read on the splash scale in the instrument if the angular travel is not greater than the magnitude of the scale readings. As soon as the range is announced, angular travel during the measuring interval is converted into angular travel during the time of flight by dividing it by the measuring interval and multiplying the result by the time of flight. If the range is available before angular travel is taken the measuring interval should be made equal to the time of flight. The angular travel in degrees and hundredths of a degree is added algebraically to previously determined lateral ballistic correction to obtain the total deflection for opening fire. All subsequent corrections for angular travel are taken care of by lateral fire adjustment.

When firing with case II pointing, the lateral adjustment corrections are incorporated into the deflection which is set on the deflection scale of the telescope mount. However, some of the 90-mm AMTB batteries are equipped with elbow telescopes provided with vertical etchings on the reticle which are used to set deflections. Applying deflections with a telescope of this kind is known as "tracking off." It is done by traversing the gun so that the vertical line corresponding to the deflection is superimposed upon the image of the observing point of the target. Tracking off is much less accurate than setting deflections on a deflection scale.

d. Corrected elevations are obtained from a range percentage corrector and are transmitted at 5-second intervals to the elevation setters at the guns. If uncorrected ranges are announced at intervals greater than 5 seconds, the interpolator must be used, thus requiring an additional operator. For a review of the operation of the percentage corrector, see paragraph 95.

■ 183. OPERATION OF HORIZONTAL BASE SYSTEM.—*a.* When a horizontal base system is employed for position finding, two short base lines ordinarily are required to insure full coverage of the field of fire. The battery commander's station or a

station close by should be the B^1 station for either base line. The B^2 and B^3 stations are located to either flank. The B^1 station is the directing point, and a correction for its displacement from the gun position is included, if necessary, in the initial correction for opening fire. The operation of this system is as follows:

b. Ranges are obtained from the plotting board. Since the B^1 station is taken as the directing point, the plotting operation is simple. The plotting board is oriented so that the push button on the platen slide represents the B^1 station and the master key represents the other station. The azimuths from the base-end stations are read every ten seconds. These data are set by the arm setters in the usual manner. As soon as the arms have been set, the platen is moved out until the master key touches the relocating arm. Since the B^1 station is taken as the directing point, the range to the target is read directly on the plotting arm opposite the platen slide index. The push button of the platen slide may be pushed to make a plotted record of the course of the target, if desired.

c. An initial range correction for travel of the target during the time of flight plus the dead time may be obtained from the plotting board, time permitting. To calculate the correction, one or two observing intervals are used as a measuring interval and the conversion to the proper correction is made as explained in paragraph 182a(2).

The application of this correction plus the range ballistic correction is the same as for the single-station system.

d. An initial lateral correction is obtained in the same manner as for the single-station system (see par. 182a(3)), or from the successive azimuth readings called out by the B^1 arm setter.

e. Corrected elevations are obtained from a range percentage corrector as described in paragraph 182a(4).

■ 184. OPERATION BY ESTIMATION.—The operation of the fire control system when estimation is used is as follows:

a. Ranges are obtained from an observer or observers who have had special training in range estimation. Their estimation may be assisted by reference to channel markers, buoys,

and other reference points already existent or purposely placed and whose ranges have been determined.

b. An initial correction for range travel during the time of flight plus the dead time is usually not warranted unless the range estimation is known to be fairly accurate, in which case a range travel correction may be estimated and applied as described under the single-station system.

c. The correction for angular travel during the time of flight may be measured or estimated and combined with the lateral ballistic correction. The resultant deflection is sent to the gun pointers.

d. Range estimations are usually made in terms of elevations and sent directly by the observer to the guns. However, in some cases it may be convenient to use the range percentage corrector, neglecting ballistic range corrections, which usually are not justified unless estimated data are known to be fairly accurate.

■ 185. ADJUSTMENT.—*a. Range fire adjustment.*—The method of performing range fire adjustment is at the discretion of the battery commander.

(1) Adjustment may be accomplished using the bracketing method. Spotting is performed from one of the azimuth instruments in the battery commander's station. (Under some wind conditions, it may be difficult to spot from the battery commander's station because of smoke from the firing. Hence, a station to the side with as small a parallax error as possible may have to be provided.) Corrections are applied on the range percentage corrector. This method of adjustment requires two operators; an observer of the splashes and a bracketing fire adjustment board operator.

(2) Adjustment may also be accomplished without the bracketing chart. In this method the adjustments must be rapid and usually bold. The range spotter observes the splashes and orders the corrections. Adjustments are based on the sensing of the deviations. Since it can be expected that a splash will be occurring on an average of one every one and a quarter seconds, with one high-explosive burst for every splash and fragmentation splashes from every burst, it may be impossible to observe individual splashes. There-

fore, as the splashes occur the observer can form an impression of the average deviation of the center of impact of a group, either over or short, and by having memorized the fork and the change in elevation per 100 yards change in range at various ranges, he will be able to order corrections without delay caused by plotting shots and without accurately determining the correction on a chart. This method has the obvious advantages of rapidity and ability to include allowance for maneuver in the determination of the corrections.

b. Lateral fire adjustment.—(1) Lateral adjustment is of prime importance since range spotting may be almost impossible without line shots in direction. Observations are made with one of the azimuth instruments provided for that purpose in the battery commander's station. Lateral adjustment corrections may be determined by—

(a) The magnitude method, in which the deviations of individual splashes are plotted except that when splashes occur nearly simultaneously, the deviation of the center of impact of the two splashes is used.

(b) The spotter who bases his estimated corrections on the average deviation of the lateral centers of impact. The corresponding corrections are ordered through a corrections rule. The corrections rule is a device which allows the adjuster to add the latest correction to the last deflection reading and obtain a new deflection in reference numbers.

(2) The first method requires a spotter and a lateral fire adjustment board operator, while the later method requires a spotter and a corrections rule operator.

■ 186. MAXIMUM AND OPENING RANGES.—The maximum effective range of the 90-mm gun against motor torpedo boats is about 8,000 yards. The tactical situation must dictate the best range for opening fire. Two considerations call for holding fire for shorter ranges. One is that motor torpedo boats can do less maneuvering during smaller times of flight. Also, shorter ranges mean flatter trajectories thus increasing the effective hitting areas.

■ 187. SEARCHLIGHTS.—The use of searchlights is of paramount importance. As pointed out, the motor torpedo boat

will probably attack at night. Because of the difficulty of tracking targets at night with searchlights, the maximum number of lights available should be employed. On account of the speed of the target, searchlights should be prepared to go into action in the shortest possible time. During an attack, when the total water area under consideration can be thoroughly illuminated by the available searchlights, such an area defense should be used. Lacking other means of surveillance, at least the required number of barrier lights should be used to prevent a run-by wherever the tactical situation permits. If possible, one light should be assigned exclusively to each battery. The remaining lights will be handled more properly by central control. Care should be taken to minimize the blinding effect on the observers caused by looking through a searchlight beam. This can be accomplished by preassigning targets. When a number of small craft are to be engaged, the situation requires not only the illumination of the one or two craft being engaged, but also the illumination of the remaining craft. If this is not done time will be lost in switching targets and some craft may slip through the defenses.

■ 188. TRAINING.—Although the fire control systems described in the preceding paragraphs are temporary or stand-by systems based on simplicity, a considerable amount of training and preparation are required to make them work smoothly at the speed required. Both the battery commander and the range officer should review thoroughly pertinent parts of this manual and FM 4-10 and study the problem at hand thoroughly. The battery must be trained to the extent that the individual operations performed by the men become instinctive. Considerable emphasis should be placed on daily training in range and deflection estimation. Ranges to channel markers, buoys, and other reference points should be memorized together with deflection data for a few selected target speeds at these ranges. Training may be conducted by checking the results of estimation against those of the standard position finding system.

CHAPTER 18

LANDWARD FIRING WITH SEACOAST ARMAMENT

	Paragraphs
SECTION I. General	189-190
II. Fire control and position finding.....	191-194
III. Preparatory measures.....	195-199

SECTION I

GENERAL

■ 189. INTRODUCTION AND PURPOSE.—Experience has stressed the importance of landward firing by fixed seacoast armament as a secondary mission. The purpose of the instructions in this chapter is to provide a guide for use by commanders in preparing for the employment of seacoast armament against land targets as a secondary mission. Since batteries will present individual problems which require special consideration, the instructions contained herein are of a general nature.

■ 190. BATTERIES TO FIRE.—Commanders should investigate carefully the possibility of the landward employment of all batteries in their commands. The following considerations will affect their decisions.

a. *Physical limitations of matériel.*—Obviously, most casemated batteries will not be suitable.

b. *Presence of immovable obstructions.*—High land masks, vital buildings, and installations near the guns will preclude firing in many cases.

c. *Suitable ammunition.*—HE shell is the most suitable ammunition for attack on most land targets. The reduced charge and deep penetration of the AP projectile make it relatively ineffective against most land targets. AP projectiles can be used, however, in the absence of other more suitable ammunition.

SECTION II

FIRE CONTROL AND POSITION FINDING

■ 191. MAPS.—So far as fire control is concerned, the primary requirement is the determination of the range and azimuth to the target. The normal method of position finding cannot be used. In general, the target will not be visible from any of the battery installations. Therefore, a suitable map for determining range and azimuth to land targets is essential. The preparation of such a fire control map must be one of the earliest steps in preparing for land firing. A project has been initiated to furnish suitable maps where required. Until these maps are issued, maps now available must be obtained, corrected, and mounted by officers in the harbor defense.

a. Features to be shown.—The scale of the map should not be smaller than 1:25,000. The map should show the following:

- (1) The directing point of the battery.
- (2) All points selected as probable observation posts.
- (3) A grid for use in locating targets.
- (4) Elevation contours.
- (5) Roads, bridges, railroads, and other likely targets.
- (6) Culture in color (woods, marshes, streams).

b. Accuracy.—A fire control map must be accurate and up-to-date. An older map, if carefully drawn, can be brought up-to-date by correction from data on other maps, by aerial photographs, and by reconnaissance. Municipal engineers of adjoining communities can often be of assistance in the preparation of maps.

c. Gun arm.—A graduated arm should be pivoted at the DP on the map. It must be graduated to the same scale as the map and should extend beyond the maximum range of the guns. In order that the azimuth of the gun arm may be read conveniently, an azimuth circle about 3 feet in diameter should be inscribed on the map. The azimuth circle should be graduated in degrees and tenths. This circle must be oriented with the same reference system as the existing battery position finding system and gun azimuth circles.

■ 192. INITIAL FIRING DATA.—*a. General.*—Due to the variation of existing fire control equipment and different situations of batteries, no specific instructions regarding the preparation of initial firing data can be laid down. The system decided upon makes use of as large a part of the existing principles and equipment as possible.

b. Uncorrected data.—When a target has been plotted on the map, the following data are obtained:

- (1) Map range.
- (2) Uncorrected azimuth.
- (3) Elevation of target.

c. Corrections.—From the map range and azimuth, initial firing data can be determined in the plotting room by means of the standard fire control devices, such as the range correction board, percentage corrector, and the deflection board. Ballistic corrections should be applied in the normal manner except for the height of site correction. It should be noted that fixed seacoast batteries employ devices which automatically correct for height of site above mean low water or whatever reference datum is used. This fact must be taken into consideration when firing at land targets with guns employing such devices (range disks or range-elevation scales computed for the height of site). For example, if a battery is equipped with range disks computed for a height of site of 30 feet, and fire is to be conducted at a target determined from contours to be 20 feet above the battery, a correction for a target 50 feet above the gun should be made. If the contour lines are referred to the same datum as the battery, the height of site correction will be that corresponding to the elevation of the target as determined from contours. The height of site correction may be applied through the operation of the range correction board if the correction is not too large, but otherwise it must be calculated.

■ 193. OBSERVATION.—*a. General.*—The two essential duties of the observers will be:

- (1) Prompt transmission of all intelligence information of prospective targets and of activities of friendly and enemy forces.
- (2) Spotting of impacts to provide a basis for fire adjustment.

b. Intelligence.—The information from the observer will often be the basis for the location of the target on the fire control map. In general, the location of the target can be more accurately determined by its coordinates or by its relation to features established on the map than by its direction and range from the observer.

c. Spotting.—In most cases, the difficulties involved in getting two observers to identify unmistakably a land target preclude the possibility of employing a two-station spotting system. In general, only one observer, well forward, should be used for any particular target. The number of forward observers required to cover adequately the field of fire will depend on the local situation.

d. Spotting reports.—The system employed by forward observers in reporting the fall of shots will vary. Axial observation from a forward position should be employed if possible, since such observation facilitates the spotting of lateral deviations. The observer should sense overs, shorts, and hits in range, and either measure or estimate the lateral deviation in angular units from his position. Unilateral observation may or may not facilitate range spotting but will make the spotting of lateral deviations difficult. The unilateral observer can report the fall of shots in reference to the observer-target line as if he were performing axial observation, or he can report the fall of shots in both range and direction in magnitude with respect to the gun-target line. Whatever method of observation is employed, the observer should take every advantage of terrain features to aid in sensing or estimating the location of the bursts. It must be remembered that when impacts fall in an area at a different elevation from the target, measured deviations may not indicate the proper correction.

■ 194. ADJUSTMENT OF FIRE.—*a. Observed fire.*—If observation of fire is possible, adjustment of fire should be accomplished by methods which follow, as closely as possible, the well established rules of the bracketing method of fire adjustment for seacoast artillery.

b. Unobserved fire.—If observation is impossible, firing will have to be conducted entirely from map data.

c. Shifting to other targets.—When adjusted firing data have been obtained on a target, effective fire on other targets in the vicinity can be undertaken quickly by correcting for the range difference and azimuth difference necessary to shift the center of impact to the new target.

SECTION III

PREPARATORY MEASURES

■ 195. RECONNAISSANCE.—A careful reconnaissance of the field of fire should be organized with particular attention to the following details:

a. Dead areas.—These should be shown on the fire control map.

b. Target location.—Location and identification of all possible targets, including road nets, bridges, defiles, landing beaches, docks, public works, oil tanks, other military installations, and favorable locations for enemy observation, operation, or concealment.

c. Selection of probable OP's.—Observation posts should command the field of fire. The number of stations will vary with the extent of the possible target area and the amount of masking obstructions. Particular attention must be devoted to arranging for ready access to these locations, the ability to maintain an observer for a prolonged period, and the accessibility to wire communications, if these are to be used.

■ 196. COMMUNICATIONS.—Equipment necessary to establish effective communications should be obtained. Every effort must be made to utilize existing telephone and radio equipment and to arrange for the prompt availability of radio equipment which can be diverted for this special use if occasion warrants. Every proposed means of communication must be thoroughly tested at the location where it is to be used before plans are made which depend on its use.

■ 197. EMBLEMMENTS.—Certain batteries, otherwise suitable for landward firing, require minor modifications before they can be used. These modifications will include such items as the removal of bulwarks to permit firing landward, removal of parapets to facilitate the service of the piece for such firing,

removal of trees, and removal or shifting of traversing stops. If certain desirable modifications should be postponed, complete plans for their execution should be prepared and the necessary tools and material obtained.

■ 198. TRAINING.—*a. General.*—The most carefully laid plans of commanders will fail if the junior officers and enlisted men have not been prepared, by carefully supervised training, to execute a mission. This is particularly important in land firing, where the scene and operations differ materially from normal combat duties.

b. Choice of personnel.—Most of the duties in the battery during land firing can be accomplished by personnel performing corresponding duties in seaward firing. This will not be true in the case of observers, whose remote location at distant base end stations will often make them unavailable for other duty. Therefore, special land observers must be selected and trained. They should be resourceful and dependable, since they will probably operate alone. In sectors where other troops are on duty and will be employed in a forward position, such troops should be utilized in their advanced position as observers for seacoast units. Coordination and training in this respect are imperative.

c. Training scope.—(1) Training in plotting room procedure must be complete and should be repeated often enough to insure a smoothly working team for determination of firing data. Training of observers should include actual field training in the following:

(a) Appreciation of terrain.

(b) Map reading.

(c) Communication.

(d) Operation of all equipment to be used.

(e) Thorough familiarity with spotting and adjusting procedure.

(2) Appreciation of terrain through actual ground reconnaissance by potential observers cannot be overemphasized. Observers should be thoroughly familiar with the terrain within range of the armament.

■ 199. EQUIPMENT.—*a. Plotting room.*—Plotting room equipment should be confined, as much as possible, to existing is-

sued devices. Maps, charts, and scales, should be held to a minimum. Any equipment beyond the authorized allowances must be improvised locally.

b. Observers.—Observers should have the following equipment:

(1) Observation instrument, such as binoculars, or azimuth instrument.

(2) Map of area visible from station.

(3) Communication equipment (radio, telephone, or visual).

(4) Orientation data.

(5) Rations.

(6) Sketch book and pencils.

CHAPTER 19

GUN DATA COMPUTER M1

	Paragraphs
SECTION I. General description and operation.....	200-207
II. Typical horizontal base problem.....	208-211
III. Summary.....	212-213

SECTION I

GENERAL DESCRIPTION AND OPERATION

■ 200. GENERAL.—*a.* The gun data computer M1 is an instrument which computes firing data for a two-gun battery when given input data furnished by any of the standard harbor defense position finding systems. It is strictly a mechanical computer and employs 115-volt, 60-cycle, alternating current for the purpose of obtaining torque amplification only. Prediction is based on determined rates of change of the target in range and azimuth. The solution for firing data is accomplished entirely by computation without the use of a plotting board.

b. Gun data computers M1 are furnished to major caliber gun batteries, the majority to 16-inch gun batteries. A smaller number is supplied to 12-inch batteries with barbette mounts.

c. All instruments are of the same standard design. However, some of the ballistic charts for each computer must be constructed for a particular battery because of varying conditions at battery locations, namely: gun displacement, latitude, and height of site. These specially constructed charts are made at the factory, and the finished product is forwarded directly to the battery for which it is manufactured.

d. For adjustment of fire the spotting board M3 or M7 and fire adjustment boards are required in addition to the computer.

e. The computer design includes data for subcaliber ammunition.

■ 201. PHYSICAL CHARACTERISTICS.—*a.* The gun data computer M1 is 7 feet long, 4½ feet high, and 3 feet wide and is mounted on a stand to raise the unit to a convenient operating level. (See figs. 152 and 153.) Operating controls, matching dials, and counters are mounted on the sides and ends of the computer.

b. The weight of the computer in the operating position is approximately 5,000 pounds. When it is being moved, a special beam support is bolted to the base, and this, with the necessary crating for shipment, increases its weight to about 7,000 pounds. (Figs. 152 and 153 show the beam support bolted to the base of the computer.)

c. Charts are constructed of sheet aluminum which have been anodized and treated by a blueprint process. This results in a blue background with white curves, giving the appearance of an ordinary blueprint.

d. Two internal electric heaters are employed to provide heat in cold climates and to aid in obtaining dryness of internal air in humid climates.

■ 202. DESCRIPTION.—*a.* Figure 152 shows, reading from left to right:

- (1) The "A" triangle solver panel.
- (2) The "B" triangle solver panel.
- (3) The "C" triangle solver panel.
- (4) The target position generator panel.

b. The three triangle solvers are used to determine the present position of the target and represent two base lines with a common station.

c. The target position generator unit is used to determine the rates of change in range and azimuth. These data are used in the formulas for predicted range and predicted azimuth. Also, on the target position generator panel is a spotting board for airplane fire control.

d. Figure 153 shows, reading from left to right:

- (1) The ballistic charts panel.
- (2) The range elevation converter panel.
- (3) The parallax panel.
- (4) The wind component indicator panel.

e. The ballistic charts panel includes a ballistic chart unit which contains charts for applying corrections to range and

azimuth due to nonstandard conditions of the following elements:

- (1) Muzzle velocity.
- (2) Elasticity.
- (3) Range wind.
- (4) Density.
- (5) Cross wind and drift.
- (6) Rotation of the earth (azimuth corrections).

(7) Remaining range corrections for tide, weight of projectile, and range rotation effects are included on the wind component indicator panel. Height of site is accounted for in the range elevation conversion chart.

f. The range elevation converter panel contains the time of flight and range elevation conversion charts that must

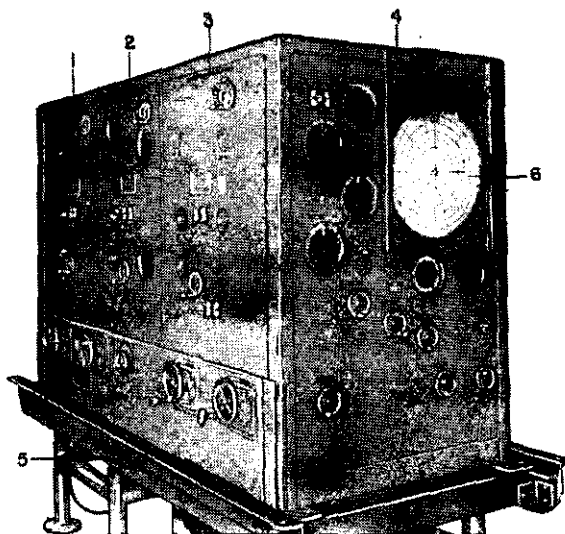

- | | |
|-------------------------------------|--|
| 1. "A" triangle solver panel. | 5. Beam support. |
| 2. "B" triangle solver panel. | 6. Airplane fire control spotting board. |
| 3. "C" triangle solver panel. | |
| 4. Target position generator panel. | |

FIGURE 152.—Gun data computer M1.

be matched by an operator. The chart selector handwheel positions the ballistic charts for various combinations of powder and projectile. The selsyn transmitters for elevation of gun No. 1 are located at the lower right of the panel.

g. The parallax panel contains selsyn transmitters for azimuth of gun No. 1, azimuth of gun No. 2, and elevation of gun No. 2. The charts of this panel contain curves which correct for the displacement of gun No. 2.

h. The wind component indicator panel contains a wind component indicator which is rotated in terms of azimuth of gun No. 1. Wind direction and speed are initially set, using the wind azimuth scale and the sliding wind speed index on the arm. An operator reads off wind reference numbers for use at the ballistic charts panel. Ballistic charts for tide,

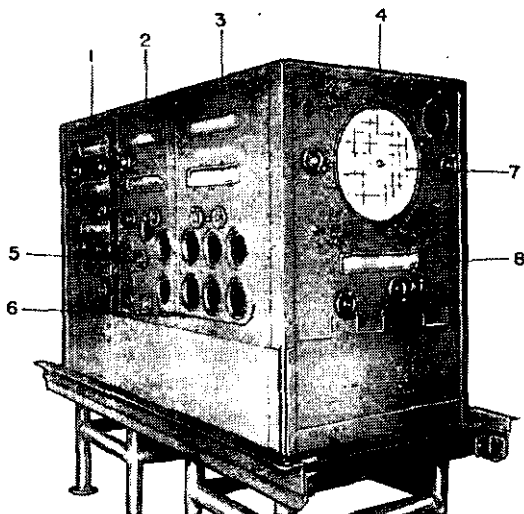

- | | |
|-------------------------------------|---|
| 1. Ballistic charts panel. | 6. Selsyn transmitter dials. |
| 2. Range elevation converter panel. | 7. Wind component indicator. |
| 3. Parallax panel. | 8. Ballistic charts for tide, weight of projectile, rotation of the earth (range correction). |
| 4. Wind component indicator panel. | |
| 5. Chart selector handwheel. | |

FIGURE 153.—Gun data computer M1.

variation in weight of projectile, and range corrections for rotation of the earth are located here. Spotting corrections from range and lateral fire adjustment boards are set in by means of the handwheels near the top of the panel.

■ 203. STAND-BY EQUIPMENT.—*a.* Experience with complicated mechanisms such as the M1 computer has proved the necessity for alternate or stand-by equipment.

b. Batteries furnished with computers are equipped also with a plotting board and a complete set of standard plotting room devices for position finding and fire control.

■ 204. OPERATION.—*a. Personnel.*—(1) The manning detail consists of 11 men, a switchboard operator, and a chief of section. For adjustment of fire, additional manning details for the spotting board M3 or M7 and fire adjustment boards are required.

(2) The operators of the computer must be trained for the alternate duties of the stand-by system, in the event of failure of the computer.

b. Methods of operation.—(1) *Position finding system employing horizontal base.*—A series of observation stations forms a number of base lines. These base lines are so laid out that as the target moves out of the effective area covered by one base line, another base line can be used. The base-end data transmission system transmits instantaneous and continuous data to the plotting room for use with the computer or the plotting board.

(2) *Data supplied from radar set.*—The data consist of electrically transmitted range and azimuth from the radar set.

(3) *A vertical base, employing a depression position finder at any of the observation stations of the battery.*—Azimuth is transmitted by the base-end data transmission system. Ranges are transmitted by telephone and set into the computer manually, as the nonlinear graduation of the range disk does not lend itself to electrical transmission of range from a D. P. F.

(4) *Airplane fire control.*—The present position, course, and speed of the target must be reported from an airplane. When a shot is fired, the airplane reports deviations by radio.

Spotting corrections are placed in the computer after having been determined from a spotting board shown on the end panel (fig. 152).

■ 205. ASSOCIATED ELECTRICAL DATA TRANSMISSION SYSTEMS.—In order to operate the computer to the greatest advantage, two electrical data transmission systems are employed.

a. A base-end data transmission system provides instantaneous and continuous data to the computer from the base-end stations. Azimuth instrument M2 and depression position finder M2, which are respectively the azimuth instrument M1910A1 and the depression position finder M1 modified by the attachment of aided tracking mechanisms and data transmitters, are furnished batteries equipped with gun data computers. The data transmission and aided tracking attachments will be furnished in kit form for conversion of the observation instruments in the field by local ordnance personnel. Radar units also are equipped with means for aided tracking and the electrical transmission of data to the computer. All position finding instruments are kept "on target" continuously.

b. An output data transmission system is employed for transmitting elevation and azimuth to each of the two guns from the computer by means of selsyn transmitters and receivers.

c. The base-end and output data transmission systems make possible instantaneous and continuous firing data for the battery.

d. The base-end data transmission system is arranged so that a change from computer to plotting board may be made readily without sacrificing aided tracking at observation stations.

■ 206. AUXILIARY MATÉRIEL.—a. The following auxiliary matériel is required for adjustment of fire in addition to the computer:

- (1) Spotting board M3 or M7.
- (2) Fire adjustment board for range adjustment.
- (3) Fire adjustment board for lateral adjustment.

b. *Power for base-end stations.*—The aided tracking attachments for the azimuth instrument M2 and the depres-

sion position finder M2 operate from 115-volt, 60-cycle, a-c power sources. The provision of adequate power supply for base-end stations is necessary. Where commercial or fortification power is available, it is used as a primary source, with a gasoline-engine generator as a secondary source. If commercial or fortification power is not available, two gasoline-engine generators are furnished for each group of base-end stations.

c. Wire communication facilities.—Two fire control cable pairs are required for data transmission from each base-end station to the computer when using the base-end data transmission system. In the case of base-end stations equipped with the azimuth instrument M2 the time interval line and the reader's line are utilized for data transmission if sufficient spare cable pairs are not available for allocation to this use. Synchronization may be accomplished over the spotter's line, since this line will not be used for spotting until firing starts. In the case of observation stations equipped with the depression position finder M2, two additional pairs must be provided, since the time interval line and the reader's line must be retained for the transmission of ranges read at regular time intervals.

d. Switchboards.—Three switchboards BD-95, 20-line, are authorized for each battery using a gun data computer. One of these switchboards should be used for switching the pairs used by the base-end data transmission system. This 20-line board will be adequate where the number of observation stations employing data transmitters does not exceed eight base-end stations and one radio set SCR-296-A. Another switchboard BD-95 should be used for switching of communication lines. The third switchboard is used in the BC station.

■ 207. EMPLOYMENT OF TIME INTERVAL SYSTEM.—*a.* The line normally used for time interval service to base-end stations equipped with azimuth instruments M2 may have to be used in the transmission of data to the computer. Even though the power supply at the base-end station should fail, time interval signals would not be required, inasmuch as the instruments still can be traversed continuously by hand. The base-end data transmission system is powered from the

plotting room, and it is considered unlikely that complete power failure will occur there, each plotting room having available secondary sources of power reasonably well protected against bombing and shell fire.

b. As stated in c below, time interval lines to base-end stations equipped with depression position finders M2 must be retained, even though the base-end data transmission system is used for the transmission of azimuth to the computer.

c. Time interval signals in the plotting room and gun emplacements must be retained for use in case of break-down of the computer. In case of break-down of the computer, the receivers of the base-end data transmission system can be used in the relaying of data to the plotting board arm setters. It is possible to uncouple the receivers from the computer input shafts in the event of computed break-down when mechanical jamming exists. The data receivers are equipped with a push button by means of which the degrees and hundredths dials may be stopped on the time interval bell so that readings may be taken. When the push button is released, the dials return to their proper position at that moment.

SECTION II

TYPICAL HORIZONTAL BASE PROBLEM

■ 208. LAYOUT.—a. Figure 154 charts a typical harbor entrance.

b. Normally, the base-end stations will be located 5,000 to 9,500 yards apart.

c. Base lines normally are not greater than 9,500 yards in length, because of difficulties in visibility and target location.

d. A study should be made of the particular situation at each harbor defense in order to employ base-end stations for the best results.

■ 209. HORIZONTAL BASE LINE SYSTEM.—The computer is designed to use two azimuth inputs with a third input ready for operation as soon as the target is obscured from one of the two stations in operation. Consider a north-south coast-line with base-end stations B¹ through B⁶ at intervals along

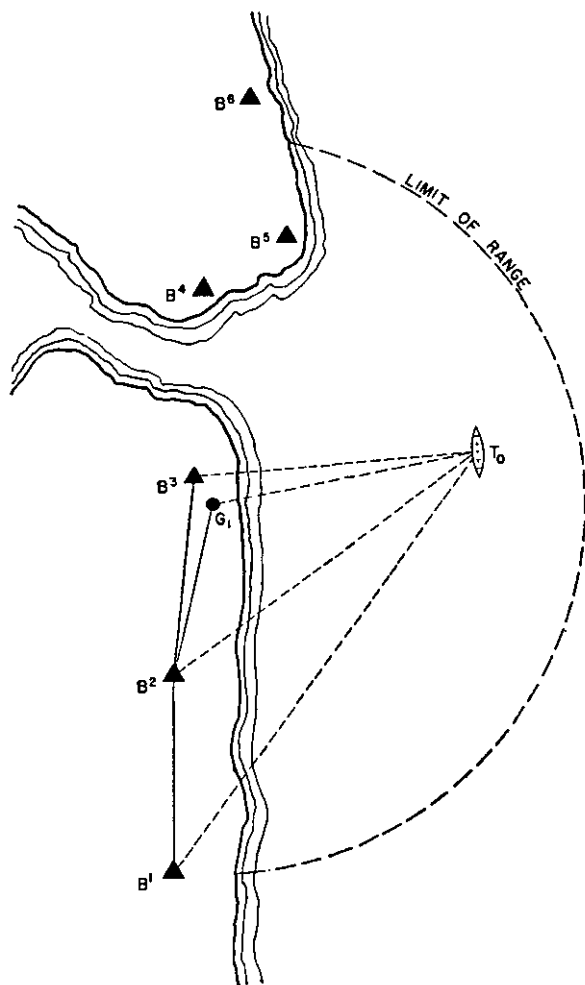

FIGURE 154.—Base line system for gun data computer triangles.

the coastline going north. The gun battery is between B² and B³ stations. A target appears traveling south and visible from B² and B³. Note that if the target remains on its course, it will eventually be visible from B¹. Under these circumstances, B³ input would be designated as A, B² input as B, and B¹ input as C. The C input operator stands by and as the target moves out of visibility of A, C will take over tracking. The B station line of sight should be the common side between a triangle containing the station, the gun, and the target, and the observing triangle containing A station, B station, and the target. Note that the C station makes another observing triangle when the time occurs for its use. Thus, three stations can be set up for use but only two are employed at any one time. All azimuths of base lines are set in looking toward B station. Any base-end station may be designated as A, B, or C, providing that the triangle containing the gun and B station has sufficient base line length and proper minimum angle of intersection.

■ 210. PREDICTION FORMULAS.—The gun data computer locates the set-forward point by solving the following equations:

$$a. R_p = \left(R_o + R_{ot} \right) \left(1 + \frac{(\Delta A)^2}{2} \right)$$

$$b. A_p = A_o + \frac{R_o \dot{A}_{ot}}{R_p}$$

For explanation of symbols used and for derivation of these prediction formulas, see appendix X.

■ 211. MECHANICAL SOLUTION.—*a. General.*—The triangle solvers of the instrument are used to obtain a solution. The triangle solvers are known as:

- (1) The "A" triangle solver (triangle ABT_o).
- (2) The "B" triangle solver (triangle BG_1T_o).
- (3) The "C" triangle solver (triangle BCT_o).

Only two of the triangle solvers are used at any one time but one of them must be the "B" triangle solver.

b. Application of data to the computer.—Refer to figures 154 and 155. Assume that observation stations B² and B³ are transmitting data to the computer. (It should be re-

membered that any other stations may be used from which the target can be seen.)

(1) The range officer must decide where the data from B^2 and B^3 will be fed into the computer for operation with the horizontal base system.

(2) In this regard, he must know the functioning of the instrument. The "B" triangle solver solves a triangle, *one point of which is the gun position.*

(3) In the "B" triangle solver, handwheels are used for setting in the azimuth and distance G_1B . The data for the "B" or gun triangle must be set into the "B" triangle solver.

(4) The range officer studies the layout (see fig. 154), and notes the distance G_1B^3 is short as compared to G_1B^2 .

(5) He decides that the "B" triangle shall consist of points G_1 , B^2 , and T_0 , since greater accuracy will result. The "B" triangle always has G_1 as one vertex, as it is the only one which contains the gun position.)

(6) Another reason for using B^2 as the B station in this situation, with the target traveling south, is that orientation data need not be changed for employment of the C and B stations when the target is not visible from A.

(7) The above procedure for any combination of observation stations should be analyzed and the results tabulated for ready reference by the range officer and the range section.

(8) Refer to figure 155, which indicates the application of data from B^2 and B^3 . In this case, the "A" and "B" triangle solvers are employed.

(9) Note that there are two triangles which have a common side between them. The observing triangle contains the "A" station, the "B" station, and the target. The gun triangle contains the "B" station, the target, and the gun battery directing point, gun No. 1. The following data are known at any instant:

- (a) Azimuth AB .
- (b) Length AB .
- (c) Azimuth line AT_0 .
- (d) Azimuth line BT_0 .
- (e) Azimuth G_1B .
- (f) Length G_1B .

These data are set into the triangle solvers of the computer.

(10) Note that by use of the data in (a) through (d) above, the lengths of BT_0 and AT_0 in the observing triangle can be obtained by use of the law of sines. The computer, by a mechanical process beyond the scope of this manual, solves for the length of these lines using the law of sines.

(11) In the gun triangle (fig. 155), it may be noted that G_1T_0 is the present range to the target, and the azimuth of G_1T_0 is the present azimuth. Therefore, by solving this triangle, present range and azimuth can be obtained. The

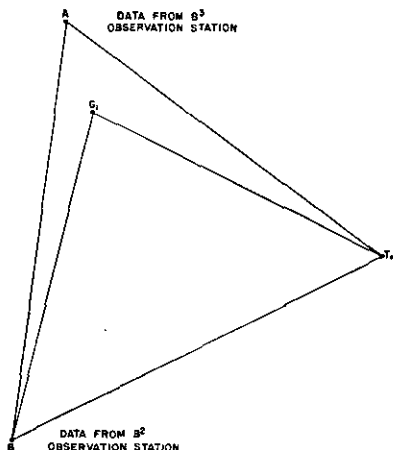

FIGURE 155.—The "A" and "B" triangles.

length of the side BT_0 is obtained from the data in (9) (d) through (f) above for the "B" triangle and from the previous solution of the observing triangle. The gun triangle is solved by the same law of sines and a trial and error process through the use of a matching dial which is displaced in proportion to the length of BT_0 as solved from the observing triangle. (The information in (9) (d) through (f) is not sufficient for a direct law of sines solution. Note that azimuth G_1T_0 is the missing information to fill this need.) Therefore, azimuth G_1T_0 , present azimuth, is changed until a length BT_0 , as solved from the gun triangle, equals that as solved from the observing triangle. This is indicated by a matched condi-

tion of the pointers on a matching dial. Thus, present range and azimuth of the target have been solved.

(12) A static situation for the problem at hand has been assumed. Actually, however, the two azimuths from the observation stations to the target will be changing, and the solutions for present range and present azimuth will change. The dynamic solution consists of a continuous process of solving these triangles.

(13) In the target position generator of the computer, the rates of change of range and of azimuth are determined from the varying values of present range and present azimuth.

(14) The rate of change of range (R_o) and the linear rate of lateral displacement ($R_o \dot{A}_o$) are carried to the predictor mechanism which uses these rates in the solving of the prediction formulas. The computer solves the basic formulas as they appear in paragraph 210 for predicted range and predicted azimuth. By means of ballistic charts, corrections for nonstandard ballistic conditions are applied to predicted range and predicted azimuth. Corrections for adjustment of fire, if required, are also introduced. Thus, the resulting firing data include ballistic and adjustment corrections.

(15) The corrected predicted range goes to the range-elevation converter where it is converted to elevation in mils. In the same unit, the time of flight equivalent to the range is determined and sent back to the predictor for use in solving the prediction equations. Corrected elevation and corrected azimuth are transmitted to No. 1 gun by a selsyn output data transmission system. The elevation and azimuth of No. 1 gun are corrected for gun displacement in the parallax unit and sent by another output data transmission system to No. 2 gun.

SECTION III

SUMMARY

■ 212. HORIZONTAL BASE OPERATION.—As the target moves along its course, two components of its velocity are determined, one along the line of fire indicated by \dot{R}_o and the other

one perpendicular to the line of fire which is equal to $R_o\dot{A}_o$. These two values go to the predicting mechanism where the prediction equations previously given are solved to determine future positions of the target at the end of the time of flight. The time of flight is obtained from a device known as a range-elevation converter and is also sent to the predictor. Ballistic corrections are obtained from charts which are mounted in the machine. Spotting corrections can be applied so that the data coming from the computer are ready to set on the guns. The M3 or M7 spotting board is used with this computer. The azimuths are introduced into the machine continuously by the base-end data transmission system which is connected to the azimuth instruments in the base-end stations. In order to insure smooth tracking, the azimuth instrument is rotated by an aided tracking device controlled by the observer (see par. 205). The range is computed and converted into elevation and then transmitted from the computer to the guns by data transmission systems which control the rotation of electrical pointers on receiver clocks at the guns. The guns are laid in elevation and azimuth by matching mechanical pointers to the electrical pointers. There is also a parallax unit which determines data for the displaced gun.

■ 213. INSTRUMENT OPERATION.—*a.* The gun data computer M1 is a fire control and position finding instrument used in place of standard plotting room instruments. However, a spotting board and a fire adjustment board are still required.

b. The tactical situation is not changed by the addition of a gun data computer to a particular battery.

c. The gun data computer is for use primarily with 16-inch or 12-inch guns mounted on barbette carriages.

d. The gun data computer M1 is supplied with charts made at the factory. Those which apply only to a particular battery are for range-elevation conversion, for effects due to rotation of the earth, and for gun displacement effects.

e. The operators of the computer must be trained to operate auxiliary (stand-by) equipment in event of failure of the computer.

f. It is intended that the base-end data transmission system be used with the computer.

g. The aided tracking feature of the base-end data transmission system makes possible greater accuracy of firing data.

h. Since output data transmission systems are employed, instantaneous and continuous firing data may be set on both guns of the battery.

i. Except for the reading of ranges at the D. P. F. station, time interval bells are not used when employing the computer with a base-end and output data transmission system. Time interval bells are installed at D. P. F. stations to provide for these range readings. In addition, time interval bells are installed in the plotting room and at the gun emplacements for use in event of failure of the computer or output data transmission system.

CHAPTER 20

GUN DATA COMPUTER M8

	Paragraphs
SECTION I. Description and operation.....	214-221
II. Theory.....	222-224

SECTION I

DESCRIPTION AND OPERATION

■ 214. **GENERAL.**—The gun data computer M8 is an electrical instrument which provides continuous firing data for certain minor-caliber batteries. The computer accepts continuous or intermittent input data and either a horizontal base or a single-station position finding system may be used. The computer operates on 115-volt, 60-cycle, single-phase power. It replaces all of the standard fire control instruments used in a plotting room except the spotting board and fire adjustment boards, which are required. All computers are of the same standard design, but the ballistic drawer of the computer depends on the type of battery for which the computer is intended. Within its type, each computer is universal for all batteries. The substitution of ballistic drawers to convert the computer from one type to another is a simple procedure. Each ballistic drawer provides firing data for three types of ammunition: two for service and one for subcaliber.

■ 215. **BATTERIES TO WHICH FURNISHED.**—The gun data computer M8 is furnished to batteries of the following types:

- a. Six-inch gun on barbette carriage M1.
- b. Six-inch gun on barbette carriages M1900 and M1910.
- c. Eight-inch gun Mk. VI, Model 3A2 on 8-inch barbette carriage M1 or 8-inch railway mount M1A1.

■ 216. **COMPONENTS.**—a. The gun data computer M8 consists of the following four components:

- (1) Power unit M14.
- (2) Line balancer M1.
- (3) Receiver M14.
- (4) Predictor M2.

b. The various components of the computer, which are connected to each other by intercabling, contain resistors, potentiometers, condensers, motor, and other electrical units; also, gears, shafts, and other mechanical units.

■ 217. DESCRIPTION OF COMPONENTS.—*a.* The power unit M14 contains rectifiers and other electrical equipment which convert the standard power used into the various voltages, both direct and alternating current, required for the operation of the computer. The power unit does not provide power for the base-end data transmission system or the gun data transmission system. The main switches for turning the power on and off are located in this unit.

b. The line balancer M1 provides facilities for balancing the data transmission lines from each of six observation stations and for switching them to one input of either or both triangle solvers of the receiver. It provides coils and terminals for a superimposed telephone circuit to each of the six stations; connection may be made readily from the terminals to a switchboard BD-95. The line balancer incorporates the power supply for the base-end data transmission system.

c. The receiver M14 consists of two identical triangle solvers and a position generator. The triangle solvers compute independently the present position of the target from the base-end data; means are afforded on the predictor for comparing the outputs of the two triangle solvers and for choosing the one which is to be used for prediction. Each triangle solver contains controls for orientation and for setting in the base-end data coming to it from the line balancer. The position generator furnishes present position during temporary obscurations of the target from the observation stations by assuming constant course and speed. The controls for this method of operation are contained on the position generator panel.

d. (1) The predictor M2 contains the prediction and ballistic elements of the computer. One end of the predictor contains the zero-set panel which contains controls for adjusting the machine electrically before operation. On the other end of the predictor the firing elevations and azimuths for both guns are indicated on dials. The front of the predictor

contains all the ballistic and spot controls and various switches and display dials. These may be tabulated as follows:

(a) Dials and knobs for inserting the known values of weight of projectile, height of site, muzzle velocity of the reference piece, temperature, wind direction, wind velocity, and air density.

(b) Dials and knobs for inserting range and azimuth spots.

(c) Switches for selecting ammunition, choice of dead time, choice of triangle solver for prediction, and selecting a 10- or 20-second data smoothing network. The READY-TO-FIRE switch is also on the predictor.

(d) Present azimuth and range from gun No. 1 to the target or from any observation station to the target are displayed on the front of the predictor. Deflection for case II firing is also displayed. The difference between the determinations of present position as given by the two triangle solvers is displayed in order to insure that both are receiving data on the same target. Finally, there are two meters for displaying the east-west and north-south components of the velocity of the target as determined by the computer.

(2) The controls for drift and rotation of the earth corrections are located on the predictor behind panels; also, behind panels are the controls for orientation of gun No. 2 with respect to gun No. 1 and for muzzle velocity difference between the guns.

■ 218. OPERATION.—*a. Personnel.*—The manning detail for the gun data computer M8 consists of a chief of section and six men. Also, manning details for the spotting board and fire adjustment boards are required for adjustment of fire.

b. Orientation of computer.—The two triangle solvers are oriented and operated independently of each other.

(1) *Horizontal base position finding system.*—One of the two base-end stations is chosen as the primary station. The east-west and north-south distances from gun No. 1 to the primary station are set into the computer on the appropriate dials at the receiver. The setting in of base line length and azimuth completes the orientation of the triangle solver.

(2) *Single station position finding system.*—The east-west and north-south distances from gun No. 1 to the observation station are set into the receiver. The base line azimuth dial is set at zero. No setting of base line length is required. The east-west and north-south distances from gun No. 1 to gun No. 2 are set in at the predictor so as to furnish correct firing data for both guns.

c. *Methods of receiving input data.*—(1) *Horizontal base position finding system.*—Observers at two base-end stations track the target. Their azimuth data are transmitted continuously and instantaneously to the receiver by means of the base-end data transmission system. Aided-drive motors at the computer assist in the matching of these data at the receiver.

(2) *Radar data.*—The data consist of range and azimuth transmitted from the radar to the receiver by means of the base-end data transmission system.

(3) *Depression position finder data.*—Azimuths are transmitted continuously by the base-end data transmission system. Ranges are transmitted by telephone and set into the receiver manually, using the aided-drive motors for assistance in matching the data; the nonlinear graduation of the range disk on the depression position finder does not lend itself to electrical transmission of range.

(4) *Intermittent data.*—For emergency operation, in case the base-end data transmission system fails, all data may be transmitted by telephone and set into the receiver manually.

d. *Other operations at the computer.*—The ballistic data are set into the predictor before firing is begun; the settings remain unchanged during firing on any one target. Balancing the lines and zero-setting the computer are also completed before firing. Present range and azimuth are read from the predictor to the spotting board as required. An operator sets in range and azimuth spots as directed by the fire adjustment operators. For target relocation purposes the present range and azimuth from any observation station to the target may be read as required. Deflections may be read for case II firing. The operation of the position generator controls is dependent on the conditions of the moment.

e. *Selection of position finding system.*—The gun data

computer M8 requires no arbitrary choice of base-end or observation stations. In general, the same considerations that apply to choice of position finding system with the plotting board apply also to the computer. Target angles below 10° or above 170° should be avoided, if possible, because of the large errors in present position caused by small errors in observation. The complete flexibility of operation resulting from the two independent triangle solvers is one of the features of the computer. It is to be noted that one triangle solver may employ a single-station position finding system while the other is using a horizontal base system. When two horizontal base systems are used, they need not have a common station which is required with the gun data computer M1.

■ 219. ASSOCIATED ELECTRICAL DATA TRANSMISSION SYSTEMS.—The same types of associated electrical data transmission systems are used as with the gun data computer M1. (See par. 205.)

■ 220. AUXILIARY MATÉRIEL.—*a. Fire adjustment.*—The following auxiliary matériel is required for adjustment of fire:

- (1) Spotting board M3.
- (2) Range fire adjustment board.
- (3) Lateral fire adjustment board.

b. Power for base-end stations.—The aided tracking attachments for the azimuth instrument M2 and the depression position finder M2 operate from 115-volt, 60-cycle, alternating-current power. Commercial or fortification power, if available, is used as the primary source, and a gasoline engine generator as a secondary source. If neither commercial nor fortification power is available, two gasoline engine generators are furnished for each group of base-end stations.

c. Wire communication facilities.—(1) Two fire control cable pairs are required for data transmission from each base-end station to the computer when using the base-end data transmission system.

(2) In the case of base-end stations equipped with the azimuth instrument M2, the time interval line and the reader's line are utilized for data transmission if sufficient

spare cable pairs are not available for allocation to this use. Coils and terminals for superimposed telephone lines are available in the line balancer M1, and the telephone lines may be superimposed on the data transmission lines if such facilities are available at the base-end station also. Synchronization may be accomplished over the spotter's line, if superimposed telephone lines are not available, since this line will not be used for spotting until firing begins.

(3) In the case of observation stations equipped with the depression position finder M2, five pairs are necessary, two for the data transmission lines, one for synchronization, one for reading of ranges, and one for the time interval bell. If superimposed telephone lines are available, this will reduce the number of pairs necessary to four.

d. Switchboards.—One of the switchboards BD-95 allocated to the battery should be used for switching the superimposed telephone lines from the line balancer M1 to the receiver M14 if those lines are available. Otherwise, telephone communications are handled in the normal manner.

■ 221. STAND-BY EQUIPMENT.—*a.* Experience with complicated mechanisms, such as the gun data computer M8, has proved the necessity for alternate or stand-by equipment. Batteries furnished with computers are equipped also with a plotting board and all other auxiliary matériel necessary for position finding and fire control in the event of failure of the computer.

b. The manning detail for the computer must be trained for the alternate operation of the stand-by system.

c. The employment of the time interval system in the event of failure of the computer or of the gun data transmission system is in general similar to that described for the gun data computer M1 (see par. 207). The following exceptions should be noted:

(1) The base-end data transmission system receivers are an integral part of the receiver M14, and no uncoupling is possible.

(2) The receiver fine dials are stopped automatically by the time interval impulse rather than manually.

SECTION II

THEORY

■ 222. PRESENT POSITION.—*a. Example.*—Let gun No. 1 be the origin of a system of rectangular coordinates with the east-west and north-south lines as X and Y axes, respectively. Let X_o and Y_o be the coordinates of the present position of the target (T_o) with respect to this coordinate system. Let X_A and Y_A denote the coordinates of an observation station A . Finally, let X_{AT_o} and Y_{AT_o} denote the east-west and north-south components of the line AT_o . It is clear that:

$$X_o = X_A + X_{AT_o}$$

and

$$Y_o = Y_A + Y_{AT_o}$$

X_A and Y_A are known and are set into the computer before tracking. X_{AT_o} and Y_{AT_o} are determined as described in *b* below.

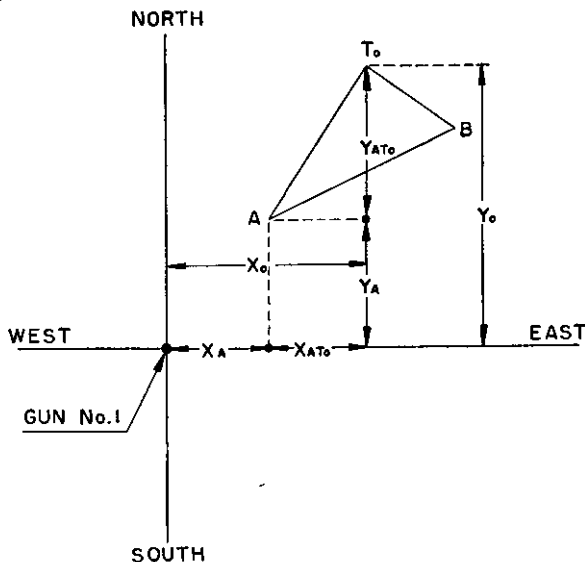

FIGURE 156.—Diagram of east-west and north-south components.

b. Horizontal base position finding system.—Let B be a second observation station. The length and azimuth of AB are known and set into the computer. The azimuths of AT_0 and BT_0 are transmitted by trackers at A and B . The computer uses the law of sines to compute the length AT_0 . It then resolves AT_0 into its components, giving X_{AT_0} and Y_{AT_0} .

c. Single station position finding system.—In this case both azimuth and range of AT_0 are transmitted from the observation station so one step of the computation just described can be omitted. The computer thus determines the present position of the target instantaneously and continuously in terms of the coordinates X_0 and Y_0 .

■ 223. PREDICTION.—*a.* Let T_p denote the set-forward point and let X_p and Y_p be its coordinates. Let t_p be the corresponding time of flight. The computer determines the rates of change X_0 and Y_0 of X_0 and Y_0 and obtains X_p and Y_p by means of the relations:

$$X_p = X_0 + \overset{\circ}{X}_0 t_p$$

$$Y_p = Y_0 + \overset{\circ}{Y}_0 t_p$$

b. In other words, prediction is based on determined rates of change of the east-west and north-south components of the position of the target. It is to be noted that the computer smooths out the instantaneous rates of change by averaging them over 10- or 20-second intervals, depending on the choice of the data smoothing network.

■ 224. FIRING DATA.—*a. General.*—Having obtained X_p and Y_p , the computer converts them into range and azimuth from gun No. 1. Ballistic and adjustment corrections are automatically added in the electrical circuits, and range is converted to elevation. The final result is firing elevation and azimuth; separate data for gun No. 2 are calculated in the computer.

b. Ballistics.—(1) The method of treating ballistics in the gun data computer M8 is unique in that it is the first approach to a theoretically correct solution of the ballistic problem; as such it deserves special mention.

(2) Firing tables list differential effects as a function of range. The assumption of such a relationship is necessary for the operation of the various plotting boards and their auxiliaries and also for the operation of the gun data computer M1. Both of these methods require that ballistic corrections for nonstandard conditions be applied independently of each other; that is, each of the individual corrections is determined as a function of a given range, and all corrections are added to obtain the total ballistic correction. It has long been recognized that this procedure is not correct; however, no other solution was practicable with plotting room equipment using charts and scales.

(3) Differential effects due to nonstandard ballistic conditions are primarily a function of the quadrant elevation at which the gun is laid and, for some conditions, of the firing azimuth also. These corrections can be obtained exactly by means of a series of successive approximations, but such a method is impracticable with charts and scales. However, the electrical computer is capable of obtaining successive approximations readily, and the gun data computer M8 is designed to solve the equations necessary to determine proper ballistic corrections. The gun data computer M8 automatically applies all corrections for the various nonstandard conditions, simultaneously and instantaneously, as a function of the firing elevation (and azimuth).

(4) Also, it has long been recognized that errors in firing data will be obtained when the second order difference due to interaction effects of the various nonstandard conditions are ignored. For example, it is known that muzzle velocity affects time of flight in a certain manner and that it affects also the correction which should be applied for density. Wherever these interaction effects are appreciable, provision has been made in the gun data computer M8 to solve the necessary equations for determining the correct solution. This is done automatically. It is evident that the gun data computer M8 provides improved methods of computing ballistic corrections, heretofore not available for seacoast artillery.

CHAPTER 21

RADIO DIRECTION FINDING EQUIPMENT (RADAR)

■ 225. GENERAL.—Standard visual position finding equipment is at a great disadvantage under conditions of poor visibility due to darkness, fog, haze, or smoke screens. Radio direction finding equipment (radar) has been developed to overcome such difficulties. A brief description of the principles of operation of radio direction finding equipment is given in the following paragraphs. A complete discussion of the principles and operation of such equipment is beyond the scope of this manual.

■ 226. FUNDAMENTAL THEORY.—*a. Range determination.*—The equipment used in radio direction finding consists of a transmitter and receiver with the necessary antennas and power sources. The transmitter emits a series of radio signals of very high frequency and very short duration, called pulses, that follow each other at very short intervals. The direction of emission is controlled by the use of a highly directive antenna which concentrates the energy of the signal in a narrow beam. When a pulse of the signal strikes an object some distance away, a portion of the energy is reflected back and is picked up by the receiving antenna which may or may not be the one used in transmitting. The elapsed time between emission of the signal and the reception of the reflected signal (echo) is measured electrically. As the rate of travel of the signal is known, the distance it has traveled can be determined by the instrument. The distance to the reflecting object is directly proportional to the elapsed time between the instant of transmission of the pulse and the instant of reception of its echo. The radio impulse travels at the speed of light, approximately 328 yards per microsecond (one millionth of a second). From this it will be seen that for a target at a range of 3,280 yards, the time of travel of the impulse each way will be 10 microseconds, or 20 microseconds for the round trip. The measurement of such short intervals of time is readily accomplished by means

of suitable circuits and is translated into range in other parts of the set.

b. Azimuth determination.—The azimuth to the reflecting object or target is determined by noting the azimuth toward which the receiving antenna must be pointed to obtain maximum signals response or by means of other suitable indications.

■ 227. RADAR EQUIPMENT.—There are two general types of radio direction finding equipment used in seacoast artillery, as follows:

a. The fire control type (the Radio Set SCR-296-A is typical), in which the direction and distance to a target is given with accuracy sufficient for fire control purposes. In this type the equipment is "beamed" or pointed at the target, and the azimuth and range are read from the indicating devices on the equipment.

b. The surveillance type (the Radio Set SCR-582 is typical), the purpose of which is to detect the presence of surface craft and furnish an approximate measurement of their ranges and azimuths. In this type of equipment, the instrument sweeps the surrounding area with a continuously rotating radio beam. The indicating oscilloscope provides a map-like presentation of the harbor area on which are indicated the locations of surface vessels and other reflecting objects such as lighthouses, buoys, buildings, and shorelines. A target in the area is indicated in its relative position on the oscilloscope face, and an operator familiar with the area is able to perceive the presence of the target. The target position is measured with sufficient accuracy to direct searchlights or fire control types of radar equipment toward the target.

■ 228. USE OF RADAR EQUIPMENT.—*a.* The SCR-296-A or other fire control radar equipment is employed in a single-station system in the same manner as depression position finders or self-contained range finders. It can be used to obtain data for a plotting board or gun data computer. It is assigned usually to a specific gun battery, but may furnish data to one or more additional batteries as a secondary mission.

b. The SCR-582 is used chiefly to indicate the presence and approximate location of surface craft. The range and

azimuth obtained are not accurate enough for fire control purposes but are good enough to direct the SCR-296-A or searchlights to the target with a minimum of searching. Because it is suitable for general purposes, the SCR-582 normally will be under the control of the harbor defense, groupment, or group commander; and should be installed in his observation post.

CHAPTER 22

ORGANIZATION AND DUTIES OF RANGE SECTION AND
OF OTHER BATTERY FIRE CONTROL PERSONNEL

	Paragraphs
SECTION I. Range section.....	229-231
II. Duties of range section details.....	232-234
III. Other battery fire control personnel.....	235-237
IV. Training.....	238-245

SECTION I

RANGE SECTION

■ 229. **DEFINITION.**—The range section of a battery is that subdivision of the personnel of the battery which performs the duties necessary for position finding and fire control. It is under the immediate command of the range officer and generally consists of the observing details, the spotting details, and the plotting room details (see par. 230).

■ 230. **ORGANIZATION.**—*a. All except rapid-fire batteries.*—(1) *Observing details.*—Each observing detail is assigned to a particular observation station (B^1 , B^2 , etc.) and is composed generally of the observer and the reader. (See par. 46c.)

(2) *Spotting details.*—Each spotting detail is assigned to a particular spotting station (S^1 , S^2 , BC tower, etc.) and is composed generally of the spotting observer and an assistant.

(3) *Plotting room detail.*—(a) Where the plotting room is equipped with either a 110°, M3, or M4 plotting board, the plotting room detail is composed of the following personnel (the numbers refer to the numbered designation of each member of the detail):

Plotter.

No. 1, angular travel device operator (case II only).

(Not needed when deflection board M1 is used.)

No. 2, primary arm setter.

No. 3, secondary arm setter.

No. 4, set-forward device operator.

- No. 5, range correction board operator.
 No. 6, percentage corrector operator.
 No. 7, deflection board operator.
 No. 8, assistant deflection board operator (note 1).
 No. 9, spotting board operator.
 Nos. 10 and 11, assistant spotting board operators (note 2).
 No. 12, spotting board recorder (note 3).
 No. 13, fire adjustment board operator (range).
 No. 14, fire adjustment board operator (lateral).
 Nos. 15 and 16, recorders (notes 4 and 5).

NOTES—1. No. 8 is used only when the deflection board M1 is employed.

2. With some spotting boards only one assistant is necessary.

3. The spotting board recorder fulfills the important function of recording the range and azimuth of the set-forward point for setting on the spotting board at the proper time.

4. Sufficient recorders are necessary to insure complete and accurate record keeping of drill and target practices. Nos. 15 and 16 are regularly assigned members of the plotting room detail. When they are not required for recording purposes they may be given other duties. They should be trained as alternates for any position in the plotting room.

5. Where the data transmission system M5 is used, four operators are required.

(b) Where the plotting room is equipped with either a relocating board M1923 (Clove) or M1 board, the plotting room detail is composed of the following personnel (the numbers refer to the numbered designation of each member of the detail): .

Plotter.

Platen operator.

No. 1, angular travel device operator (case II only).

(Not needed when deflection board M1 is used.)

No. 2, plotting arm setter.

No. 3, relocating arm setter.

Nos. 4 to 16, inclusive (same as plotting room detail, (a) above).

b. *Rapid-fire batteries*.—(1) In a rapid-fire battery equipped with full plotting room equipment, the observing details are as described in a (1) above. There are two spotting details, each composed of a spotting observer and an

assistant. One spotting detail functions at an axial station to observe the sense of the range deviations and the other detail at an axial station to observe the magnitude of the lateral deviations. The plotting room detail is as described in *a(3)(b)* above, except that Nos. 9, 10, 11, and 12 are omitted.

(2) In a rapid-fire battery not provided with regular plotting room equipment, the men who would ordinarily form the range section are grouped with the additional personnel enumerated in section III. The combined unit might consist of the following personnel, depending on local conditions:

- Observer, battery commander's (azimuth).
- Reader, battery commander's.
- Observer, self-contained range finder.
- Reader, self-contained range finder.
- Observer, spotting (range).
- Assistant to spotting observer (range).
- Observer, spotting (lateral).
- Assistant to spotting observer (lateral).
- Operator for any improvised equipment, such as time-range board, if used.
- Range correction ruler or range percentage corrector operator.
- Deflection board operator (or chart operator).
- Fire adjustment board (or over-short adjustment chart) operator.
- Display board operator (if necessary).
- Telephone operators, one for each phone.
- Recorder.

■ 231. DUTIES, GENERAL.—*a.* The primary duty of the range section is to furnish suitable data at all times and under all conditions so that the battery can perform its tactical mission satisfactorily. The ability to fire so as to destroy the enemy and gain success in battle should be the only consideration in training and service (see sec. IV). When details are posted twice daily for equipment checks, each member of the range section examines, adjusts, and tests the functioning of the particular device or apparatus operated by him. After determining whether it is in satisfactory condition for service,

each man awaits for his chief of detail to command REPORT. At the command REPORT each member of the section reports in turn, "—— in order," or reports any defects which cannot be corrected without delay.

b. Each member of the range section is responsible at all times for the care, adjustment, condition, and serviceability of the device, instrument, or apparatus operated by him. Where a single device is common to more than one member of the range section, as in the case of the spotting board, the chief of the detail is responsible.

c. At the conclusion of drill, practice, or action, the battery commander commands: BATTERY DISMISSED. The range officer commands: CLOSE STATIONS, and each of the position finding personnel makes secure his device or instrument. The chiefs of details supervise the replacing of equipment and the policing of stations.

NOTE.—During war these commands would generally not apply as all stations are kept on some form of alert and continuously ready for action.

d. Description of the detailed operation of position finding apparatus is included in chapters 7 to 14 inclusive.

SECTION II

DUTIES OF RANGE SECTION DETAILS

■ 232. OBSERVING DETAILS.—*a. Observer.*—The observer is responsible to the range officer for the care, adjustment, and use of his instrument; for the policing of his station; and for the functioning of his detail. At appropriate times he makes a careful inspection and examination of his station, orients his instrument, tests the means of communication, and has the reader report to the plotter, " B^1 (or B^2 , etc.) in order," or reports such defects as he is unable to remedy without delay. When a target has been indicated and assigned by the battery commander and identified by the observer, the latter reports, " B^1 (or B^2 , etc.) on target." When the battery commander has given the command TRACK, the observer follows the target with his instrument, keeping the cross wires thereof accurately centered on the observing point on the

target. When the final bell of each time interval signal strikes, if azimuths are transmitted by telephone, he stops following the target long enough to permit his reader to read and transmit the required data to the plotting room. If a continuous data transmission system is used to transmit azimuths he keeps the vertical cross wire on the target continuously.

NOTE.—In stations equipped with a depression position finder, the instrument is kept in adjustment for reading both ranges and azimuths so as to be able to track using either the vertical base or horizontal base system. This insures readiness for a change of system if required. When the station is in continuous operation the orientation (both range and azimuth) of the instrument is checked at least twice a day, once as soon as it is light each morning, once just before dusk, and at other times during the day as the need arises.

b. Reader.—The reader functions under the direction of his observer. He assists in the care, adjustment, and orientation of the observation instrument and in the policing of the station. He performs such duties as are directed by the observer; tests the functioning of his communication with the plotting room, and reports to the observer. When the target has been assigned and tracking is started, if continuous data transmitters are not being used, the reader reads from the observation instrument at each time interval the azimuth, or the azimuth and the range, and transmits these data to the proper arm setter in the plotting room. During drill or target practice the reader records these data for use in the analysis.

■ 233. SPOTTING DETAILS.—*a. Spotting observer.*—The observer is responsible for the care, adjustment, and use of his observation instrument, for the functioning of his detail, and for the policing of his station. At appropriate times he makes an inspection of the station and equipment, tests the means of communication, orients and adjusts his instrument, and reports to the plotter, "S¹ (or S², etc.) in order." He identifies the target when assigned, reports to the battery commander, "S¹ (or S², etc.) on target," and thereafter follows the target with the vertical cross wire of his instrument. He must have the vertical cross wire on the tracking point of the target when the splash occurs in order to make correct readings.

When the splash occurs, he stops tracking momentarily and reads the deviation of the splash. If reading angular deviations, he reads the deviation on the internal splash scale. If he desires, he may move the splash pointer to the splash or center of impact of a group of splashes to facilitate the reading. He then reads the deviation indicated on the internal scale by the pointer. If reading the sense of the range deviation, he keeps his vertical wire on the observing point of the target and the top of the splash scale slightly below the waterline of the target. The deviation is then sensed as over, short, or hit. The deviations are transmitted to the proper operator in the plotting room. The telephone used for this purpose is frequently operated by the spotting observer himself but may be operated by the assistant. If more than one battery is firing at the same target, in order to insure the identification of the splashes of the shots fired by his battery, the observer must be informed from the battery of the instants of firing and of the expiration of the times of flight.

b. Assistant.—The assistant functions under the direction of the spotting observer. He performs such duties as are directed by his observer, tests the functioning of his communication with the plotting room, and reports to his observer. His duties vary according to the desires of the observer. He should observe the angular deviation of the fall of shots with a range rake until the battery has obtained good adjustment. The purpose of this is to provide a means of determining deviations in case splashes occur outside the field of view of the observer's instrument. He may operate the telephone, act as recorder during drills and target practices, and assist the observer in identifying his own battery's splashes. The assistant should also be well trained in the use of the observation instrument so that he can relieve the observer during prolonged periods of observation.

■ 234. PLOTTING ROOM DETAIL.—*a. Range officer.*—The range officer commands the battery range section and is responsible to the battery commander for the condition, adjustment, and use of the battery position finding equipment, for the training and efficiency of the battery range section, for the serviceability of the battery communication system, and for the policing of the stations pertaining to the battery position

finding system. When the battery is firing, his station is in the battery plotting room. At other times he may go wherever his presence is necessary in the performance of his duties. At appropriate times he makes a careful examination of the plotting room equipment and apparatus. He verifies the adjustment of all position finding equipment and apparatus as often as may be necessary to assure their proper operation and their readiness for service at all times. He makes frequent inspections of all observation, spotting, and alternate stations. When drill or firing is imminent and all the manned stations have reported, "In order," to the plotter, he receives the report of the plotter and, in turn, reports to the battery commander, "Sir, stations in order," or reports such defects as he is unable to remedy without delay. During drill, practice, or action he maintains constant supervision over the functioning of the plotting room detail and, insofar as he is able to do so from his station in the plotting room, over the entire battery position finding system. He ascertains that such records are kept as are necessary for the analysis of the drill or target practice. He makes such changes in the assignment of position finding personnel to duties as are necessary for the efficiency of the battery as a whole. During firing he supervises the adjustment of fire in range and direction, making such decisions as may be necessary when questions arise.

b. Plotter.—The plotter is chief of the plotting room detail and as such is responsible to the range officer for the adjustment, condition, and serviceability of the plotting room apparatus; for the training and efficiency of the plotting room detail; and for the condition and policing of the plotting room. He receives the reports from the observation stations, from the spotting stations, and from the various members of the plotting room detail; and reports to the range officer, "Sir, range section in order," or reports such defects as he is unable to remedy without delay. He is responsible for the orientation, adjustment, and use of the plotting board. During drill, practice, or action, the plotter plots on the plotting board the points representing the positions of the target at times of observation (plotted points) and determines the set-forward points. For a detailed description of his duties in plotting, see chapter 10.

c. *Platen operator.*—The platen operator is necessary only when a plotting and relocating board is used. He assists the plotter in the orientation of the plotting board and during plotting operates the platen in the manner set forth in paragraph 78.

d. *Angular travel device operator.*—(1) For case II pointing, using the 110°, M1923, M1, M3, or M4 boards, No. 1 operates the angular travel computer or other similar device. (See pars. 101 and 102.) Using the azimuths of successive set-forward points determined on the plotting board, he determines from the angular travel device the reference number for use on the deflection board. When the deflection board M1 is used, No. 1 is eliminated.

(2) For case III pointing with the 110°, M1923, M1, M3, or M4 boards, No. 1 is eliminated.

e. *Primary arm setter (plotting arm setter), No. 2.*—(1) No. 2 is equipped with a telephone headset on the line from the B¹ reader. Prior to drill, practice, or action he receives and transmits to the plotter the report from the B¹ station. After the command TRACK is given, No. 2 sets the B¹ arm of the plotting board at the azimuth received from the B¹ reader when the horizontal base or B¹ vertical base is being used. When B² vertical base is used, the B¹ arm setter's headset is connected in parallel with the line to the B² arm setter. No. 2 then listens for the range as transmitted by the B² reader. He repeats this to the plotter after the B² arm has been set at the azimuth to the target. In this case, No. 2 will also operate the gun arm.

(2) Where the M1923 board or the M1 board is used, No. 2 is the plotting arm setter. The plotting arm may be used to represent azimuths from either B¹ or B², depending upon the orientation of the board. The plotting arm setter is equipped with a headset on the line from an observation station (B¹ or B²) and sets the plotting arm at the azimuth of the target as transmitted by the reader at that station. The duties of No. 2 are the same for horizontal, self-contained, and vertical base systems, except where the vertical base or a self-contained base station is at the directing point of the battery, in which case the plotting arm of the plotting board is not used.

f. Secondary arm setter (relocating arm setter), No. 3.—

(1) No. 3 is equipped with a telephone headset on the line from the B^2 reader. Prior to drill, practice, or action he receives and transmits to the plotter the report from the B^2 station. After the command TRACK is given, No. 3 sets the B^2 arm of the plotting board at the azimuth received from the B^2 reader when the horizontal or B^2 vertical base is being used. When B^1 vertical base is used, the B^2 arm setter's headset is connected in parallel with the line to the B^1 arm setter. No. 3 then listens for the range as transmitted by the B^1 reader. He repeats this to the plotter after the B^1 arm has been set at the azimuth to the target. In this case, No. 3 will also operate the gun arm.

(2) When either the M1923 board or the M1 board is used, No. 3 is the relocating arm setter. The relocating arm may be used to set the azimuth of either B^1 or B^2 , depending upon the orientation of the board. The relocating arm setter is equipped with a headset on the line to the observation station corresponding to the relocating arm and sets the relocating arm at the azimuth of the target as transmitted by the reader at that station. After the plotter has made his prediction, the relocating arm setter brings his arm up to the set-forward point. The plotter reads and calls out the range to the set-forward point, and the arm setter reads and calls out the azimuth. When vertical base is used with the station at the directing point of the battery, which is seldom the case, the relocating arm will be used for plotting. In this case, No. 3 receives the azimuth from the station and sets his arm. No. 2 transmits the range to the plotter, who locates the plotted point and predicts. No. 3 measures the azimuth to the set-forward point as before.

*g. Set-forward device operator, No. 4.—*No. 4 operates the set-forward rule and calls out to the plotter the travel to the set-forward point. This operator is not required when the set-forward scales are used by the plotter. His duties are the same for all systems of position finding.

*h. Range correction board operator, No. 5.—*No. 5 functions in the manner set forth in chapter 11 and transmits the ballistic range correction to No. 6. For details of his duties, see paragraph 87. Except when the deflection board M1

is used, he operates the wind component indicator in the manner set forth in paragraph 84.

i. Percentage corrector operator, No. 6.—No. 6 operates the percentage corrector in the manner set forth in paragraph 95. He is equipped with a telephone head set on a line to the guns.

j. Deflection board operator, No. 7, and assistant operator, No. 8.—No. 7, assisted by No. 8 when necessary, operates the deflection board and transmits to the guns deflections for case II pointing or azimuths for case III pointing. See chapter 12 for methods of operation of deflection boards.

k. Spotting board operator, No. 9, and assistant spotting board operators, Nos. 10-11.—No. 9, assisted by Nos. 10 and 11, by use of the spotting board, determines the range and, if desired, lateral deviations. See chapter 14 for methods of operation of spotting boards.

l. Spotting board recorder, No. 12.—No. 12 records the range and azimuth to the set-forward point as called out by the plotter and arm setter. He calls these off to the spotting board operator at such a time that the correct range and azimuth may be set on the spotting board for each shot.

m. Range fire adjustment board operator, No. 13.—No. 13 conducts the adjustment of fire in range by use of the fire adjustment board or of the bracketing adjustment chart in the manner set forth in paragraphs 154 and 157, respectively. This operator should be an enlisted man who has been properly trained by the range officer. In case any questionable points arise, they should be settled by the range officer.

n. Lateral fire adjustment board operator, No. 14.—No. 14 conducts the adjustment of fire in direction by use of the fire adjustment board (see par. 154*d*). This operator should also be an enlisted man who has been trained by the range officer.

o. Data transmission device operator, No. 15.—When mechanical data transmission devices are used, No. 15 receives the corrected range or elevation and the corrected deflection or azimuth from the proper persons and sets them at the proper time on his device. For zone fire he also keeps

the proper zone indicated. When the data transmission system M5 is used, four operators are required.

p. Recorders, Nos. 16 and 17.—These recorders, if required, help keep records necessary for the analysis of drill or target practice. They should also be trained as substitutes for other operators in the plotting room.

NOTE.—For a rapid-fire battery without full plotting room equipment, the fire control personnel perform their duties in a manner similar to that of corresponding personnel as described in preceding paragraphs, with such modifications as the somewhat different equipment makes necessary.

SECTION III

OTHER BATTERY FIRE CONTROL PERSONNEL

■ 235. **GENERAL.**—Exclusive of the firing section of a battery, certain other individuals, some of whom are not shown in Tables of Organization as members of the range section, are necessary to assist the battery commander in the conduct of fire. The number required will vary, depending on the matériel manned. These men are members of the headquarters section of the battery headquarters and are listed as basics. They are under the immediate command of the battery commander and function in the battery commander's station. The detail is usually called the battery commander's detail.

■ 236. **PERSONNEL.**—The detail ordinarily is composed of the following personnel:

- a. One or more observers.
- b. One bugler.
- c. One telephone operator.

■ 237. **DUTIES.**—*a. For case II pointing.*—(1) Each observer performs such duties in connection with the observation of targets and splashes as may be prescribed by the battery commander. Each is responsible for the orientation, adjustment, care, and operation of his instrument.

(2) The bugler performs such duties as may be prescribed by the battery commander. He may be called on to sound bugle signals; to act as telephone operator, recorder, orderly,

or messenger; or to perform certain duties in connection with prediction tests as described in paragraph 245.

(3) The telephone operator transmits and, if so ordered, records all commands and messages to or from the station. He is responsible for the care and operation of his telephones. He may be required to show the clock time of messages sent and received.

b. For case III pointing.—(1) An observer performs the duties of the observer in the conduct of prediction tests as described in paragraph 245. Each observer performs such other duties in connection with the observation of targets and splashes as may be directed by the battery commander. Each is responsible for the orientation, adjustment, care, and operation of his instrument.

(2) The bugler performs his duties as indicated for case II pointing.

(3) The telephone operator performs his duties as indicated for case II pointing

SECTION IV

TRAINING

■ 238. GENERAL.—*a.* The training of the fire control and position finding personnel of a battery must be thorough and painstaking. Each individual must be possessed of an intimate knowledge of the functions, care, and operation of the instrument or device operated by him, and must possess a satisfactory general knowledge of all other position finding devices and the systems of position finding used by the battery. Each must understand the relation of data determined by him to data determined by others. Each individual should be so trained and drilled as to be expert in the operation of his own device, proficient in the operation of at least one other device, and have a knowledge of the operation of all devices.

b. In addition to the regularly assigned position finding personnel, substitutes for all positions must be trained in order to provide replacements for absentees or casualties, to the end that the continuous, efficient functioning of the position finding system will be insured. Under war condi-

tions at least four men must be assigned to each observation or spotting station so that a continuous watch may be maintained. At least two of these men must be qualified observers so that a complete manning detail may be available at all times.

■ 239. PLOTTER.—The plotter will be trained thoroughly in the detailed functioning of all apparatus or devices employed in the battery position finding system, in all methods of position finding contemplated for the use of the battery, in the methods of pointing, in the keeping of records, and in the analysis of drill and target practice. He must be trained in estimating the probable movements of targets based upon observed positions, in the making of accurate predictions, and in the coordinated functioning of the position finding system and the firing battery. The plotter should be capable of taking over the duties of the range officer, in case of the latter's absence or of his becoming a casualty.

■ 240. OBSERVERS (BASE-END).—*a.* Observers must be selected for their special aptitude for such duty. A fundamental requirement is that of excellent vision. They must be trained in the care, operation, and adjustment of all observation instruments employed by the battery, and in the use of the instrument or instruments to which they are regularly assigned; they must be able to distinguish characteristics, features, and formations of warships and of other naval craft; they must know the subdivisions of the battery's water area (field of fire); they must be skilled in the identification of all prominent features in the water areas, such as channels, buoys, lighthouses, and datum points; in the systems of position finding and the methods of fire used by the battery; in the commands employed in the indication and identification of targets; in the functioning of the battery communication system and the use of the telephone; and in the coordinated functioning of the position finding system and the firing battery.

b. In addition to the training outlined above, spotting observers will be trained in the various methods of adjustment employed by the battery; in distinguishing between the impacts of projectiles of different calibers when falling

together; in the location of the center of impact of a salvo; in the operation of the system of spotting; and in the operation of the spotting board used by the battery. Ordinarily, observers will be trained in the duties of both spotting and position finding in order that they may be rotated in the various jobs.

■ 241. READERS.—Readers must be trained in those subjects outlined for the training of observers. Each must possess in only a slightly less degree the qualifications of his observer and be trained so as to function efficiently as a relief to the observer during long periods of observation. They must be trained in the proper and careful keeping of the records of data determined at their stations; in the essentials of the battery communication system; and in the care and use of the telephone and the transmission of orders, commands, and messages.

■ 242. OTHER PERSONNEL.—*a.* Each individual member of the plotting room detail must be trained in the systems of position finding employed by the battery; in the methods of pointing; in the detailed functioning, care, adjustment, and operation of his device or apparatus under all conditions; in the general operation and use of all other plotting room devices; in the use of telephones; in the coordinated functioning of the position finding system of the firing battery, in the analysis of drill and target practice; and the keeping of records for drill and target practice.

b. Plotting room details must be trained in the accomplishment of rapid changes of orientation and the alternative use of all base lines established for the battery. The training must be such that a change of orientation necessitated by a change of base lines may be made in the shortest possible time and with a minimum interruption of the processes of position finding. To this end, range officers will organize the details and the mechanics of reorientation so as to effect the necessary changes with a minimum of effort, assigning to each member of the range section necessarily affected certain duties to be performed when commands are given requiring changes of orientation, and coordinate these duties so as to insure the expeditious accomplishment of results.

■ 243. USE OF HYPOTHETICAL COURSES.—Much of the training of a range section is conducted by assigning as targets for tracking commercial vessels in the field of fire. When these or other suitable targets are not available, recourse must be had to the use of hypothetical courses. Several of these courses should be on hand at all times. The data for them may be computed mathematically, determined graphically from the plotting board, or made up by recording readings actually taken on targets at some previous time. A computed course serves as a check on the accuracy of the operators of the plotting board as well as a check on the mechanical accuracy of the board. However, for training, courses prepared by determining the data graphically or courses for which the data are recorded from actual readings on targets previously tracked are satisfactory and are more easily prepared.

■ 244. DRILL.—After the members of the range section have become familiar with the mechanical operation of the devices assigned to them, they must be trained to operate as a team. This training is accomplished by drilling the entire range section as a unit. To be effective, this drill must be carefully supervised and analyzed continuously so that errors in operation may be eliminated. Long hours of unsupervised drill will not increase the efficiency of the range section but will tend to tire the men and make them careless. The careful analysis of the drill will enable the range officer to determine the best men for each assignment. This analysis of drill is one of the most important duties of the range officer.

■ 245. PREDICTION TESTS.—*a.* In the calculation of case III firing data for rapidly moving targets, it is important that predictions in direction as well as in range be accurately made. Range predictions are checked by analysis of drill. Lateral predictions are checked by prediction tests. These tests should be made frequently, during routine drills, to disclose any flaws in the plotter's procedure and to assist in the formulation of rules to be used by him in the location of the set-forward point.

b. The prediction testing detail should consist of an observer, a reader equipped with a stop watch that will run in

synchronism with the TI signals, and an assistant supplied with a time of flight chart or scale.

c. The observer tracks the target with an accurately oriented azimuth instrument. The reader keeps his stop watch synchronized with the TI signals. The uncorrected range to the set-forward point whose azimuth is being checked is sent to the assistant, who determines and calls off to the reader the time of flight. The reader notes the time of the firing signal and at the end of the time of flight calls, "Halt," whereupon the observer stops tracking long enough for the reader to read and record the azimuth.

d. This azimuth, corrected for the azimuth difference between the observation station and the directing point, should check with the uncorrected azimuth of the set-forward point as determined by the plotter. If there are appreciable discrepancies between these two azimuths, the work of the plotter should be checked to determine the cause of the errors so that corrective measures may be taken.

CHAPTER 23

FUNCTIONING OF FIRE CONTROL AND POSITION
FINDING SYSTEMS

	Paragraphs
SECTION I. General	246
II. Action before target is assigned.....	247
III. Action when target is assigned.....	248-251
IV. Functioning when using other equipment.....	252-255
V. Functioning of spotting system.....	256

SECTION I

GENERAL

■ 246. **GENERAL.**—*a.* The equipment to be found in the plotting room of any one seacoast artillery battery will differ from that in almost any other battery. There are several reasons for this. The newly developed instruments are not furnished to all batteries, especially the older batteries. Again, the requirements of the batteries are different, depending on caliber and range. And finally, minor modifications are made in the systems to suit the preferences of the battery officers.

b. Obviously it would be impossible to describe the operation of all possible combinations of the numerous instruments and improvised instruments that are in use without burying the main idea in a mass of detail. It has been thought best to describe the operation of one system only and to give in later paragraphs necessary notes on the variations of this system when other instruments are substituted. Only the more important cases of this kind are considered.

c. The system chosen is that shown in figure 157. It is for a battery of fixed guns of major caliber. The plotting room is equipped with a plotting board M4 (using 2 mechanical arms); range correction board M1A1; percentage corrector M1; deflection board M1; spotting board M3; and fire adjustment board M1. The base-end observers and the spotting observers are equipped with azimuth instruments M1910A1.

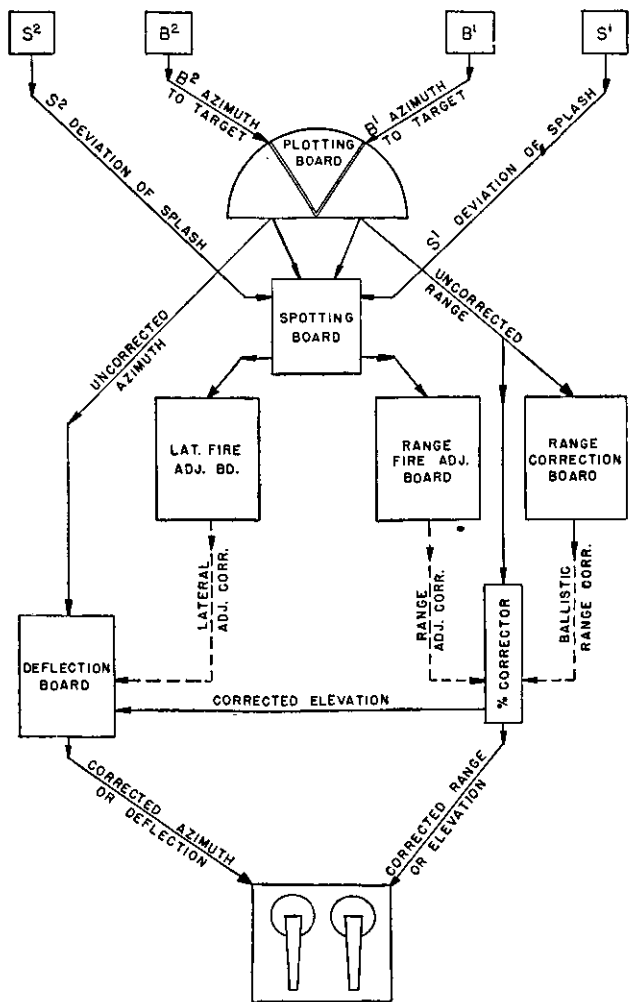

FIGURE 157.—Routing of position finding and firing data—schematic diagram.

SECTION II

ACTION BEFORE TARGET IS ASSIGNED

■ 247. PREPARATION FOR CALCULATION OF DATA.—*a.* In order to insure that the range section is ready to function at any time, all equipment and communication lines should be inspected twice daily. These inspections should include—

- (1) Orientation of observation instruments.
- (2) Orientation of plotting board.
- (3) Zeroing of correction devices.
- (4) Checking all moving parts for binding (especially wooden parts).
- (5) Testing of communication lines. These inspections, if carefully made, will insure the range section being ready for action at any time.

b. All communication lines are tested by the men who operate them.

c. The meteorological message is received by the man designated for that duty and is recorded on a form drawn up by the range officer. The proper ballistic density and ballistic wind to use cannot be determined until the target is assigned and its range determined. If the air temperature at the battery is to be based on the meteorological message, it may now be determined by correcting the atmospheric temperature at the meteorological station for the difference in the elevation of the meteorological station and the battery. If the temperature is to be measured directly, it is determined from a reliable thermometer at or near the battery.

d. The tide message is received from the tide station and recorded.

e. All possible information as to weights of projectiles is received from the battery executive. By coordination within the battery, this information can be in the hands of the range officer well in advance of the time the projectiles will be used.

f. A record of all available information as to the action of the powder on hand in the battery is maintained by the range officer. This includes information as to its previous performance, reduced to standard temperature, together with powder tag markings, present temperature, and other infor-

mation. The range officer will have determined beforehand the muzzle velocity to be assumed with any combination of ammunition likely to be used, and insofar as possible the battery commander will give both the range officer and the battery executive advance warning as to the combination that will be ordered.

SECTION III

ACTION WHEN TARGET IS ASSIGNED

■ 248. PRELIMINARY STEPS.—*a.* The assignment of the target to the battery by the group commander will be followed by its assignment to the various elements of the battery by the battery commander. This assignment will convey the battery commander's decision as to the ammunition, the observation and spotting stations, the case of pointing, and the method of tracking to be used.

b. The following steps are taken immediately by the plotting room detail:

(1) The plotting board is made ready for tracking, using the stations and method of tracking ordered.

(2) The required communication set-up is arranged by proper manipulation of the switchboxes.

(3) The spotting board is made ready for spotting, using the stations ordered.

(4) The operators of the range correction board, percentage corrector, and deflection board turn to the charts corresponding to the ammunition ordered.

(5) The operator of the range correction board makes notations of the muzzle velocity, height of site (tide), weight of projectile, and temperature (elasticity) curves to be used.

c. The observers designated to track the target, and the gun pointers when case II pointing is ordered, identify the target and bring their instruments or guns to bear on it. Each then reports, "----- on target." As each reports on target, a battery officer commands TRACK, without waiting for others to get on.

d. The observers follow the target as prescribed in paragraph 232*a*. If vertical base tracking has been ordered, the observer tracks in azimuth as described, and in addition he

tracks in range by keeping the horizontal wire of his instrument at the waterline of the target. At the final stroke of the bell, he holds both the azimuth reading and the range reading stationary long enough for the reader to transmit them to the plotting room.

■ 249. APPROXIMATE DATA.—*a.* As soon as the plotting room has received the first readings from the observation stations, the position of the target is plotted, and the plotter calls out, "Approximate data." He then reads off the range to the plotted point and the operator of the gun arm reads off the azimuth to that point, both call out loud enough to be heard by all in the plotting room.

b. Using this approximate range, the ballistic wind zone is selected and the ballistic wind and ballistic density are taken from the meteorological message by the range officer. The ballistic density and rotation curves to be used on the range correction board are noted. The direction and speed of the ballistic wind are set on the deflection board.

c. The deflection board operator turns the deflection board to the approximate azimuth. This determines the range and lateral components of the ballistic wind for use on the range correction board and on the chart of the deflection board itself. The chart is turned to the approximate range, the pointer is brought to the curve corresponding to the lateral wind component, and an approximate azimuth is sent to the guns if case III pointing is being used. For example, the operator transmits, "Approximate azimuth, 34.57." This enables the azimuth setters to point the guns in the direction of the target.

d. The range correction board operator turns his chart to the approximate range, takes the range component of the ballistic wind from the deflection board, and determines an approximate ballistic correction. This he transmits to the operator of the percentage corrector.

e. The percentage corrector operator turns his range scale to the approximate range and transmits the approximate range or elevation to the guns according to the units by which the guns are pointed in elevation. For example, he transmits "Approximate range 9,780." After receiving the ballistic correction, he sends to the guns a second approxi-

mate range (or elevation), if it differs materially from the first.

f. The spotting board is set to the approximate range and azimuth.

g. The procedure given in *a* through *f* above may be repeated for each plotted point until the course of the target has developed satisfactorily for sending out corrected data.

■ 250. CORRECTED DATA.—*a.* After the course of the plotted points has steadied so that prediction is possible, the plotter makes a prediction as described in paragraph 73. The range and the azimuth of the set-forward point are called out for all to hear. All other data are transmitted in tones as low as reliable transmission will permit. The outstanding characteristic of a well-trained range section is that it is quiet.

b. The percentage corrector operator sets the range to the set-forward point on his board, uses the ballistic correction and adjustment correction (if one has been computed) already set, and determines the firing range or elevation according to the units used for pointing the guns in elevation. He transmits the firing range or the firing elevation to the guns immediately or holds it for transmission on signal, according to the method in use in that particular battery.

c. The deflection board operator sets the range and the azimuth of the set-forward point on his board, using the lateral component of the ballistic wind that shows on the wind resolving mechanism after the azimuth is set. If pointing is by case III, the corrected azimuth is read from the board by the assistant operator. If pointing is by case II, travel is computed by a device built into the board. This device is operated by the assistant who computes the deflection and transmits it immediately to the guns. (See par. 107c.)

d. The range correction board operator sets the range to the set-forward point on his board, follows the curves, and gives a new ballistic correction to the percentage corrector operator when it changes by 0.1 percent.

e. As soon as operations are proceeding smoothly and corrected firing data are being sent to the guns, the battery commander is notified by the report "course OK."

■ 251. VOICE PROCEDURE IN PLOTTING ROOM.—Delay and confusion in the plotting room may be reduced by the adoption of simplified methods of calling off or transmitting data between operators in the plotting room. The calling off of ranges can be simplified as shown in the following examples. A range of 12,250 yards could be called off as twelve—two—fifty while 12,200 yards would be called off as twelve—two—hundred. The plotter, in calling travel to the operator of the set-forward rule, can use a similar system. Since he will measure the travel only to the nearest 10 yards, the units figure may be disregarded and a travel of 270 yards could be called out as two—seventy or more simply two—seven. The same would apply to distances called back by the set-forward rule operator. Experience should show the range officer which method is best for his section.

SECTION IV

FUNCTIONING WHEN USING OTHER EQUIPMENT

■ 252. PREDICTION SCALE.—When the prediction scale is used, a set-forward rule is required to give the plotter the travel during the dead time plus time of flight. In this case the operation is performed by the set-forward device operator.

■ 253. OTHER PLOTTING BOARDS.—*a. Plotting boards M3 and M4 using optical arms.*—An additional operator is required to set the azimuths on the azimuth indicator for each optical arm used.

b. 110° plotting board.—The operation for the 110° board is the same as that described in paragraph 73.

c. Plotting and relocating boards M1923 (Clove) and M1.—When these boards are used an additional operator, called the platen operator is required.

■ 254. UNIVERSAL DEFLECTION BOARD.—When the universal deflection board is used, an angular travel computer is necessary to compute the uncorrected deflection.

■ 255. WIND COMPONENT INDICATOR.—The wind component indicator is used when the battery is not equipped with the deflection board M1. It is operated by the range correction board operator.

SECTION V

FUNCTIONING OF SPOTTING SYSTEM

■ 256. METHOD OF OPERATION.—*a.* Each spotting observer tracks the target, keeping the vertical wire of his instrument on the observing point. When the splash occurs, tracking is stopped immediately, and the angular deviation of the splash is then read from the deflection scale in the instrument and is transmitted to the spotting board. (See pars. 139 and 233.) Axial observers observe on the center of the splash; flank observers observe on the edge of the splash nearest the battery.

b. To assist the spotting observers in identifying the splash, a stop watch kept at the spotting board is started when the shot is fired and, when the time of flight has elapsed, the warning "Splash" is called out to the observers. The spotting board should be set to the uncorrected range and target azimuth corresponding to the salvo that is being spotted. It will be necessary to have a recorder to write down the uncorrected range and azimuth to each set-forward point and furnish these data to the operators at the proper time. As a salvo is fired, he should check off the set of data corresponding to that salvo and should call it off at the proper time to the operators of the spotting board so that the board may be positioned to receive the spot from the spotting stations.

c. The angular deviations observed by the spotting observers are set into the spotting board. Range corrections in reference numbers are read off the spotting board and transmitted to the range fire adjustment board operator. If lateral adjustment of fire is being conducted by use of a separate observer stationed at or near the directing point, lateral corrections are transmitted directly from the observer to the lateral fire adjustment board. The lateral corrections need not be read from the spotting board. If lateral corrections determined on the spotting board are to be used as the basis for the lateral adjustment of fire, they are read in reference numbers and are transmitted to the person designated to make the adjustment. Lateral adjustment corrections may be determined graphically on an improvised board similar to the fire adjustment board used for range adjustment (see par. 154*d*).

CHAPTER 24

FIRE CONTROL AND POSITION FINDING FOR
SUBCALIBER PRACTICE

■ 257. GENERAL.—Due to decreased ranges in subcaliber firing, there are certain precautions which should be taken before a subcaliber practice. Of course, these will depend on the equipment being used and also on the type of armament.

■ 258. HORIZONTAL BASE SYSTEM.—In order to assure a good intersection on the plotting board, the length of the base line should be reduced in about the same proportions as the range. Where possible to change the scale of the plotting board, as on the M1923, it will usually be advisable to use a larger scale in order to keep the plotted course well away from the center of the board. If necessary, the spotting base line should also be reduced to get a good intersection at the target. If the M3 or M7 spotting board is used, it usually will be advisable to use the largest scale that will cover the field of fire.

■ 259. DEFLECTION BOARDS.—Care must be taken to see that the proper subcaliber charts for the deflection board are being used.

■ 260. RANGE CORRECTION BOARD.—The range correction board must be set to use the subcaliber chart instead of the regular chart.

■ 261. PERCENTAGE CORRECTOR.—Ordinarily, a gun equipped with a range disk will have an extra range disk, graduated for subcaliber firing, in which case there need be no change in tape on the percentage corrector. In case subcaliber range disk is not available, it will be necessary to have a range-range tape. However, if the gun is pointed in elevation by means of angular units, a range elevation tape for the subcaliber ammunition must be used on the percentage corrector.

■ 262. SET-FORWARD DEVICES.—If a set-forward slide rule is used, the range scale must correspond to the times of flight for subcaliber ammunition. Set-forward scales, when used, if selected according to time of flight, can be the same as used for standard ammunition, but if marked in range, must be marked for subcaliber ranges.

CHAPTER 25

CARE AND PRESERVATION

■ 263. GENERAL.—The following instructions are for the guidance of coast artillery personnel in the care and preservation of the instruments discussed in this manual. The proper use and care of precision instruments are greatly facilitated by careful training of the men who actually use the instruments. Unit commanders should make every effort to provide their men with the appropriate technical manuals issued for the using arms.

■ 264. CARE IN HANDLING.—*a.* In general, fire control and sighting instruments are rugged and well suited to the purposes for which they have been designed. However, they will not stand rough handling or abuse; inaccuracy and malfunctioning will result from such mistreatment.

b. Disassembly and assembly by battery personnel are permitted only to the extent authorized in the paragraphs dealing with the individual instruments. Unnecessary turning of screws or tampering with other parts not incidental to the use of the instrument are expressly forbidden.

c. Keep the instruments as dry as possible. Do not put an instrument in its carrying case when wet.

d. When not in use, keep the instruments in the carrying cases provided, or in the condition indicated for traveling.

e. Cover the leveling vials when they are not in use.

f. Any instruments which indicate incorrectly or fail to function properly after the authorized tests and adjustments have been made are to be turned in for repair by ordnance personnel.

g. No painting of fire control equipment by battery personnel is permitted.

h. Many worm drives have throw-out mechanisms to permit rapid motion through large angles. When using these mechanisms, it is essential that the throw-out lever be fully disengaged to prevent injury to the worm and gear teeth. When reengaging the worm, turn the crank slowly and release the throw-out gently until the teeth of the worm are fully meshed.

i. Fire control mechanisms move freely and smoothly throughout the range of the instrument. The mechanisms must not be forced against the stops provided at the extremes of the range.

j. When using a tripod with adjustable legs, be certain that the legs are clamped tightly to prevent possibility of collapse.

k. When setting up tripods on sloping terrain, place two legs on the downhill side to provide maximum stability.

■ 265. LUBRICATION.—*a.* The instruments should be lubricated when required with lubricants furnished by the Ordnance Department for fire control instruments. The lubricants commonly used are: oil, lubricating, for aircraft instruments and machine guns; grease, special, low temperature.

b. Use only the lubricant specified for each use.

c. Lubricants for fire control instruments function also as rust preventives. They should be used carefully and diligently. Excessive lubrication should be avoided.

d. The exterior of instruments should be kept free of dirt, dust, and seeping oil. Remove oil from metal surfaces with cloth slightly moistened with solvent, dry cleaning, and wipe dry with a clean cloth.

■ 266. OPTICAL PARTS.—*a.* To obtain satisfactory vision, it is necessary that the exposed surfaces of the lenses and other parts be kept clean and dry. Corrosion and etching of the surface of the glass, which greatly interfere with the good optical qualities of the instrument, can be prevented or greatly retarded by keeping the glass clean and dry.

b. Under no condition will polishing liquids, pastes, or abrasives be used for polishing lenses and windows.

c. For wiping optical parts use only lens paper specially intended for cleaning optical glass. Use of cleaning cloths in the field is not permitted. To remove dust, brush the glass lightly with a clean, camel's-hair brush and rap the brush against a hard body in order to knock out the small particles of dust that cling to the hairs. Repeat this operation until all dust is removed. With some instruments an additional brush with coarse bristles is provided for cleaning mechani-

cal parts; it is essential that each brush be used only for the purpose intended.

d. Exercise particular care to keep optical parts free from oil and grease. Do not wipe the lenses or windows with the fingers. To remove oil or grease from optical surfaces, apply ethyl alcohol with a clean camel's-hair brush and rub gently with clean lens paper. If alcohol is not available, breathe heavily on the glass and wipe off with clean lens paper; repeat this operation several times until clean.

e. Moisture due to condensation may collect on the optical parts of the instrument when the temperature of the parts is lower than that of the surrounding air. This moisture, if not excessive, can be removed by placing the instrument in a warm place. Heat from strongly concentrated sources should not be applied directly, as it may cause unequal expansion of parts, thereby resulting in breakage of optical parts or inaccuracies in observation.

■ 267. DESTRUCTION OF FIRE CONTROL EQUIPMENT IN EVENT OF IMMINENT CAPTURE.—*a. General.*—Instruments and other items of fire control equipment are difficult to repair in the field. Every effort should be made to keep such equipment from falling into enemy hands in usable condition.

b. Instruments.—(1) *General.*—Inasmuch as instruments are light and small, every effort should be made to evacuate instead of destroying them. If necessary, they should be given priority over nonessential organizational equipment such as typewriters. However, when limited evacuation is possible, careful consideration should be given to the question of what matériel to save and what to destroy. The requirements of the using troops in the immediate future is an important consideration. All fire control equipment, including optical sights, is difficult to replace. It should be the last equipment to be destroyed, if there is any chance of personnel being able to evacuate. If evacuation of personnel is made, all possible items of fire control equipment should be carried. If evacuation of personnel is not possible, fire control equipment must be thoroughly destroyed.

(2) *Optical instruments.*—All optical equipment such as azimuth instruments and depression position finders will be thoroughly destroyed. Optical elements of instruments

(lenses and prisms) and level vials are easily destroyed with a hammer or other heavy instrument. The electrical equipment should be smashed, and the rest saturated with gasoline and ignited.

(3) *Plotting room equipment.*—Most plotting room equipment can be destroyed satisfactorily by burning. All metal and electrical parts of such equipment should be thoroughly smashed, using an ax or sledge.

(a) *Fire control and position finding boards.*—Wooden boards are to be burned and metal boards smashed with an ax or sledge.

(b) *Firing tables, charts, and slide rules.*—These items are to be thoroughly burned.

(4) *Data transmitters.*—Rubber sheathed cables of data transmission, remote control, and cable systems should be stacked, saturated with gasoline, and burned. The data transmitter may be destroyed by TNT charges. Also, many of the parts may be destroyed by an ax or sledge.

(5) *Computers or directors.*—Demolition with TNT is the most satisfactory method. Remove telescopic sights and smash with an ax or sledge. Remove side, front, and rear covers. Place 1-pound TNT charges connected together with detonating cord in each side. Insert tetryl nonelectric cap with at least 5 feet of safety fuze in one charge. Replace covers as tightly as possible without damaging the fuze. Ignite the fuze and take cover. All cables and wires must be heaped in a pile, saturated with gasoline, and burned.

(6) *Seacoast artillery power plants.*—All auxiliary power equipment should be rendered useless. Electric motors and generators can most effectively and easily be put out of operation by injuring the field or armature windings. If time is available, the motor shell may be broken with a sledge and the coils ruined with a crowbar. If time is short, a small arms bullet fired into each coil will effectively destroy it. A 45- or 30-caliber bullet may easily be directed into the coils through the air vents in either end bell, but care should be taken to see that nobody is in the path of ricochet. Switch panels, sockets, plugs, and fuse or circuit breaker panels should be smashed with a sledge or ax.

APPENDIX I

GLOSSARY

NOTE.—Definitions of other terms used in coast artillery will be found in FM 4-18.

Absolute deviation.—Shortest distance from center of target to point of impact.

Accuracy of fire.—Accuracy of fire is determined by dispersion and is measured by the closeness of the grouping of points of impact about their center of impact.

Adjustment correction.—See Range adjustment correction and Lateral adjustment correction.

Adjustment of fire.—Process of determining and applying corrections to firing data to bring the center of impact on the target and to keep it there.

Aerial observation.—Observation of fire from aircraft.

Aiming point.—Point on which gun pointer sights when pointing gun in direction.

Altitude.—Vertical distance above or below a specified datum level, usually sea level at mean low water. It is sometimes called height of site.

Angle of departure.—The angle between the line from the gun to the target and the axis of the bore when the projectile leaves the muzzle.

Angle of elevation.—Angle between line from gun to target and axis of bore when piece is pointed in elevation.

Angle of fall.—Angle between line of fall and base of trajectory.

Angle of jump.—Difference between angle of departure and angle of elevation. Its component in the vertical plane is called vertical jump and its component in the horizontal plane is called lateral jump.

Angle of site.—Angle between line of site and base of trajectory.

Axial observation.—Observation of fire from a point on or near battery-target line. An axial station is one from which angle battery-target-station is less than 5°.

Axis of bore.—Center line of bore of gun.

Axis of trunnions.—Axis about which a gun is rotated in elevation.

Azimuth.—Horizontal angle, measured in a clockwise direction, from a reference line passing through the position of observer to the line joining observer and objective.

Azimuth difference.—Difference, due to displacement, between azimuths of a point measured from two other points; or angle subtended at point in question by a line connecting the two other points. It is also called parallax.

Backlash.—The lost motion or play in a mechanical system.

Ballistic coefficient.—A measure of the ability of a projectile to overcome air resistance and maintain its velocity.

Ballistic conditions.—Conditions which affect the motion of projectiles in the bore and through the atmosphere. Among these conditions may be included muzzle velocity, weight of projectile, size and shape of projectile, wind, rotation of projectile, rotation of earth, density of the air, and elasticity of the air.

Ballistic corrections.—Corrections applied to uncorrected range and direction to set-forward point to compensate for effect of ballistic conditions upon the movement of the projectile.

Ballistic density.—A fictitious, constant density of the atmosphere which would have the same total effect on the projectile during its flight as the varying densities actually encountered.

Ballistic wind.—A fictitious wind, constant in magnitude and direction, which would have the same total effect on the projectile during its flight as the true winds actually encountered.

Ballistics.—Science dealing with behavior of projectiles in motion. Interior ballistics deal with behavior of projectiles in motion in the bore of a gun. Exterior ballistics deal with behavior of projectiles in motion through the atmosphere.

Base line.—Line of known length and direction between two observation stations or two spotting stations, positions of which are known with respect to battery.

Base of trajectory.—Straight line between muzzle of gun and level point, considered to be coincident with horizontal.

Base ring.—Metal ring which is bolted to concrete of emplacement and which supports weight of gun and carriage.

Battery manning table.—Table containing list of names detailing personnel of a battery to their posts.

Battle chart.—Chart used in group or higher command station, showing water area covered by armament of that command.

Bilateral observation.—Observation of fire from two observation stations.

Bore rest.—See Clinometer rest.

Bore sighting.—Process by which axis of bore and line of sight are made parallel or are made to converge on a point.

Bracketing correction.—An adjustment correction which gives an equal number of overs and shorts.

Bracketing salvo.—Salvo in which number of impacts sensed short is equal to number of impacts sensed over.

Calibration.—Determination, by actual firing, of elevation and deflection corrections to be applied to individual pieces of the battery in order that their true centers of impact will be brought as close together as possible.

Cant.—Angle made with horizontal by axis of trunnions.

Case I pointing.—See Pointing.

Case II pointing.—See Pointing.

Case III pointing.—See Pointing.

Center of dispersion.—See Dispersion.

Center of impact.—Point the deviation of which is the mean of deviations of the several shots of a series.

Chronograph.—Instrument for measuring and recording short intervals of time. More specifically, an instrument for determining velocity of projectiles.

Clinometer rest.—Device inserted in bore of gun at muzzle for supporting clinometer. It is also called *bore rest*.

Coefficient of form.—Factor introduced into ballistic coefficient to make its value conform to results determined by firing.

Conduct of fire.—Employment of technical means to place accurate fire on target. Fire is usually conducted by the battery which is the normal fire unit.

Continuous fire.—Fire conducted at normal rate without interruption for application of adjustment corrections or for other causes.

Corrected azimuth.—Azimuth from directing point to set-forward point corrected for all known variations from those conditions assumed as standard in construction of firing tables.

Corrected deflection.—Deflection corrected for all known variations from those conditions assumed as standard in construction of firing tables.

Corrected elevation.—Firing table elevation corresponding to corrected range.

Corrected range.—Range to set-forward point corrected for all known variations from those conditions assumed as standard in construction of firing tables.

Danger space.—Area indicated by projecting target onto surface of the water by lines parallel to line of fall of projectile.

Data line.—Telephone line used for transmission of data. (See Intelligence line.)

Datum level.—Spherical surface which represents mean low water or other specified reference level from which altitudes are measured.

Datum point.—Fixed point, the azimuth and range of which have been determined from one or more observation stations or other positions.

Dead time.—Interval between instant of observation on target and instant at which guns may be fired with firing data which were calculated as a result of that observation.

Defilade.—Vertical distance by which a position is concealed from enemy observation. If smoke and flash of firing are also concealed, battery is said to have smoke and flash defilade.

Deflection.—Horizontal angle between vertical plane containing target and vertical plane containing axis of bore when piece is pointed in direction. It is usually expressed in reference numbers and is set on the telescope. Deflection due to travel alone is called uncorrected deflection.

Deliberate fire.—Fire which is conducted at a rate intentionally less than normal rate of fire of battery for purpose of applying adjustment corrections between series or for tactical reasons.

Deviation.—Distance of point of impact or center of impact from center of target. If a set of axes is drawn through target, *Y* axis being along gun-target line and *X* axis perpendicular to *Y* axis, then the *Y* coordinate of point of impact is called the longitudinal (or range) deviation and *X* coordinate is called the lateral deviation. The shortest distance from center of target to point of impact is called absolute deviation.

Difference chart.—Graphic device by means of which range and azimuth of a target from a gun or station are obtained when range and azimuth from some other gun or station are known.

Directing point.—Point in or near a battery for which range and azimuth to target are determined in computing firing data. It is commonly referred to as the DP. It may be one of the guns or it may be a point centrally located with respect to the guns.

Directrix of battery.—Center line of field of fire.

Dispersion.—Scattering of shots fired with same data. Area over which shots are scattered is called "zone of dispersion." Center of area is called "center of dispersion."

Dispersion ladder.—Diagram made up of eight successive zones, each equal to one probable error, in each of which is indicated percentage of shots expected to fall therein; center of dispersion is on line between the two central zones. There is a dispersion ladder for range and one for direction.

Displacement.—Horizontal distance from one point to another is displacement between these points. (See Gun displacement.)

Drift.—Divergence of a projectile, due to its rotation and resistance of air, from the vertical plane containing line of departure. It may be expressed in either linear or angular units.

NOTE.—Drift listed in firing tables includes lateral jump.

Elevation.—See Angle of elevation and Quadrant elevation.

Elevation difference.—Angular units of quadrant elevation corresponding to gun difference for a particular range.

Elevation table.—Table of ranges with corresponding quadrant elevations, used in graduating and in checking

graduation of range disk of fixed gun. Quadrant elevations listed are firing table elevations corrected for height of site.

Field of fire.—That portion of terrain or water area covered by fire of gun or battery.

Fifty percent zone.—Zone extending one probable error on each side of center of dispersion within which 50 percent of shots are expected to fall.

Fire control.—Exercise of fire direction and conduct of fire. Fire control equipment and installations are used both for tactical direction of fire and for technical conduct of fire.

Fire control installation.—Equipment which is employed in fire control of any unit.

Fire direction.—Exercise of tactical command of one or more units in selection of objectives and in concentration or distribution of fire thereon at appropriate times.

Fire discipline.—Efficiency of personnel in action. It includes accuracy and alertness resulting from organization, drill, and coordinated effort.

Fire for effect.—Fire which has for its primary object accomplishment of the tactical effect sought. The tactical effect sought might be destruction of enemy ships or denial of use of certain channels or areas.

Firing azimuth.—Corrected azimuth further corrected for an individual gun. It includes individual corrections for displacement and for calibration.

Firing data.—General term employed in speaking of range (or elevation) and azimuth (or deflection), either corrected or uncorrected, which are used in pointing a gun.

Firing elevation.—Firing table elevation corresponding to firing range.

Firing range.—Corrected range further corrected for an individual gun. It includes individual corrections for displacement, for lack of level of base ring, and for calibration.

Firing tables.—Collection of data, chiefly tabular, intended to furnish ballistic information necessary for conducting fire of a particular model of gun with specified ammunition.

Fixed armament.—Seacoast artillery weapons which are emplaced in permanent firing positions.

Flank observation.—Observation of fire from a point on or near the flank. A flank station is one from which angle battery-target-station is greater than 75° .

Flash defilade.—See Defilade.

Fork.—Difference in range or elevation or in direction required to change center of impact by four probable errors.

Grid azimuth.—Azimuth measured from grid north. Formerly called *Y* azimuth.

Gun difference.—Difference, due to displacement, between range from gun to target and that from directing point to target.

Gun displacement.—Horizontal distance from pintle center of gun to directing point of battery.

Gun parallax.—Azimuth difference between line from directing point to target and line from gun to target.

Gunner's quadrant.—Instrument used on quadrant seat on breech of gun to measure inclination of axis of bore to horizontal.

Gunnery.—Art and science of firing guns. It includes a study of flight of projectile and of technical considerations involved in conduct of fire.

Height of site.—Vertical distance above or below a specified datum level, usually sea level at mean low water.

High angle fire.—Fire delivered at elevations greater than elevation corresponding to maximum range.

Hitting area.—Arbitrarily defined as area extending three probable errors on each side of center of dispersion in range as well as in direction.

Horizontal base system.—System of position finding in which target is located by intersection of two lines of known direction from two observation stations.

Hundred percent rectangle.—Rectangle the length of which is eight probable errors in range and the breadth of which is eight probable errors in direction. Its center is center of dispersion. It is expected to contain practically all shots.

Intelligence line.—Telephone line used for transmission of orders and messages as distinguished from data. (See data line.)

Jump.—See Angle of jump.

Lateral adjustment correction.—That correction determined from actual firing which places center of impact on target in direction.

Lateral deviation.—See Deviation.

Lateral jump.—See Angle of jump.

Level point.—Point on descending branch of trajectory at same altitude as muzzle of gun. (Same as Point of fall.)

Line of collimation.—Line from center of objective lens of telescope through and perpendicular to the axis of vertical rotation.

Line of departure.—Prolongation of axis of bore as projectile leaves muzzle of gun. It is tangent to trajectory at origin.

Line at elevation.—Prolongation of axis of bore when piece is laid.

Line of fall.—Tangent to trajectory at level point.

Line of site.—Straight line connecting origin of trajectory with given point. (Also called Line of position.)

Longitudinal deviation.—See deviation.

Low angle fire.—Fire delivered at angles of elevation at and below elevation corresponding to maximum range.

Magnitude method of adjustment.—Method of adjustment used when deviations are measured by spotting.

Map range.—Range from the piece to any point as scaled or computed from a map.

Mask.—Any natural or artificial feature of or on terrain which affords shelter from view.

Maximum ordinate.—Difference in altitude between muzzle of gun and highest point of trajectory.

Meteorological datum plane.—Reference plane for data furnished to artillery concerning atmospheric conditions. Its altitude is that of meteorological station.

Mil.—One sixty-four-hundredth part of a circle. For practical purposes, arc which subtends a mil at center of circle is equal in length to $\frac{1}{1000}$ of radius. Arc and its tangent are nearly equal for angles not greater than 330 mils.

Mobile armament.—Seacoast artillery weapons which may be moved to and emplaced in temporary firing positions. This class consists of railway, truck-drawn and tractor-drawn artillery.

Muzzle velocity.—Velocity of projectile at muzzle. (Also called Initial velocity.)

Normal of scale.—Reference number which represents zero units of value concerned.

Observing interval.—Time interval between two successive observations made on moving target during tracking.

Observing point.—Point on which observers sight.

Observing sector.—Sector between lines to right and left limiting area visible to observer or limiting area assigned for surveillance.

Orientation.—(1) Determination of horizontal and vertical location of points and establishment of orienting lines.

(2) Adjustment of azimuth circle of gun or of instrument to read azimuths.

Orienting line.—Line of known direction, over one point of which it is possible to place an angle measuring instrument.

Parallax.—See Azimuth difference.

Pattern.—Pattern of a salvo in range is difference in range between point of impact with longest range and point of impact with shortest range, excluding wild shots. Pattern of a salvo in direction is distance measured perpendicular to line of position between point of impact falling at greatest distance to right, and that falling at greatest distance to left, excluding wild shots.

Pintle center.—Vertical axis about which a gun and its carriage are traversed.

Plotted point.—Point on plotted course of target located by means of observations taken at end of observing interval.

Point of impact.—Point where projectile first strikes ground or other material object.

Pointing.—Operation of giving piece a designated elevation and direction. There are three general cases of pointing—

Case I.—Pointing in which both direction and elevation are given the piece by means of a telescope pointed at the target.

Case II.—Pointing in which direction is given to the piece by means of a telescope pointed at the target and elevation by means of a data transmission system elevation receiver, elevation quadrant, or range disk.

Case III.—Pointing in which direction is given the piece by means of telescope pointed at an aiming point other than the target, an azimuth circle, or a data transmission system azimuth receiver and elevation by means of a range disk, elevation quadrant, or data transmission system elevation receiver.

Position finding.—Process of determining range and direction of target, or predicted position of target, from battery.

Predicting.—Process of determining expected position of target at some future time.

Primary armament.—Seacoast artillery weapons of 12-inch or greater caliber.

Probability factor.—Factor used as an argument in entering probability tables. It is equal to error not to be exceeded divided by probable error.

Probable error.—Error which is as likely as not to be exceeded. Value which will in long run be exceeded half the time and not exceeded half the time.

Quadrant elevation.—Vertical angle between horizontal and axis of bore when gun is pointed in elevation.

Range.—Horizontal distance from gun, observation station, or directing point of a battery to target, splash, datum point, or other specified point.

Range adjustment correction.—Correction determined from actual firing which places center of impact on target in range.

Range deviation.—See deviation.

Range difference.—Difference, due to displacement, between ranges from any two points to a third point.

Ranging shots.—Trial shots fired at a moving target for purpose of obtaining an adjustment correction to be used in entering fire for effect.

Reference line.—Line to which directions or azimuths are referred. Line of zero azimuth for a particular system would be a reference line.

Reference numbers.—Arbitrary numbers used in place of actual values in graduation of certain scales. Their purpose is to avoid use of positive and negative or right and left values.

Relocation.—Process of determining range and azimuth from one station to target (or other point) when range and azimuth from another station to target (or other point) are known.

Remaining velocity.—Remaining velocity at any point of trajectory is actual velocity in feet per second at that point.

Retardation.—In ballistics, negative acceleration of projectile.

Ricochet.—Glancing rebound of projectile.

Round.—Component parts of ammunition necessary in firing of one shot.

Salvo.—One shot per gun, fired simultaneously or in a certain order, with specified time interval between rounds.

Salvo point.—Point of known range and azimuth at which fire from one or more batteries may be directed.

Seacoast artillery.—All artillery weapons used primarily for fire upon hostile naval vessels. It includes both fixed and mobile armament.

Secondary armament.—Seacoast artillery weapons of less than 12-inch caliber.

Self-contained range finder.—Instrument used to obtain ranges by either stereoscopic or coincidence principle.

Sense.—Direction of point of impact (or center of impact of salvo) with respect to target, that is, over or short, right or left.

Set-forward point.—Point on expected course of target at which it is predicted target will arrive at end of time of flight.

Sight.—Device by which gun pointer gives gun direction for firing. It is more commonly called a telescope.

Site.—Place where gun battery, target, or other object is located.

Slope of fall.—Degree of inclination of line of fall to horizontal. It is usually expressed as a gradient, for example, one on five, meaning that projectile drops vertically 1 yard while it is moving horizontally through 5 yards.

Spotting.—Process of determining deviations or sensings for use in adjustment of fire.

Straddle.—Salvo which has impacts of opposite sense. (Also called Mixed salvo.)

Stripped deviation.—Deviation which would have resulted had there been no personnel errors and no adjustment corrections applied.

Subareas.—Subdivisions of water area in field of fire, used to assist in indication, identification, and assignment of targets.

Summit of trajectory.—Highest point on trajectory.

Terminal velocity.—Remaining velocity at point of fall.

Time of flight.—Elapsed time from instant projectile leaves muzzle to instant of impact or to instant of burst.

Tracking.—Process of making successive observations on a moving target for purpose of plotting its course.

Trajectory.—Curve described by center of gravity of projectile in flight.

Uncorrected deflection.—Deflection due to travel of target during time of flight.

Unilateral observation.—Observation from a station so located that angle battery-target-station is between 5° and 75° .

Vertical base system.—System of position finding in which target is located by direction and distance from single station using depression position finder.

Vertical jump.—See Angle of jump.

Zone.—When used with reference to mortar fire or to fire from guns or howitzers using more than one size powder charge, it refers to area in which projectiles will fall when one particular size powder charge is used and elevation is varied between elevation for minimum range and elevation for maximum range for that particular powder charge.

Zone of dispersion.—See Dispersion.

APPENDIX II
DISTANCES TO HORIZON

Height of site feet:	<i>Distance (yards)</i>
25	11,600
30	12,700
35	13,800
40	14,700
45	15,600
50	16,400
55	17,300
60	18,000
65	18,800
70	19,500
75	20,100
80	20,800
85	21,500
90	22,100
95	22,700
100	23,300
150	28,500
200	32,900
250	36,800
300	40,300
400	46,500

APPENDIX III

ORIENTATION OF DEPRESSION POSITION FINDER IN RANGE ON DATUM POINT ABOVE WATERLINE

■ 1. In section III, chapter 7, range adjustment of the depression position finder by waterlining a datum point was discussed. When locations for data points in the water are not available, data points on land can be used. Such a datum point might consist of a concrete block or post on which is painted a horizontal line which is used as a false waterline in orienting the depression position finder. This false waterline should be as close to sea level as practicable.

■ 2. The range to the datum point is found by any convenient surveying method. The range reading to be set on the depression position finder when oriented on such a datum point can be computed mathematically. The range disk setting will depend upon the height of tide. For convenience, a chart can be made showing for various heights of tide either the range disk setting or the correction to be added to the map range to obtain the range disk setting. The range to the waterline is determined by the following formula:

$$\frac{c}{R_o - R} = \frac{b}{R_o} - \frac{9R}{7r}$$

- c = the height in feet of the datum point above tide
 b = the height in feet of the instrument above tide
 R = the map range in yards to the datum point
 R_o = the range disk setting
 r = the radius of the earth = 6,963,455 yards

Let

$$\frac{9}{7r} = K$$

Therefore

$$\frac{c}{R_o - R} = \frac{b}{R_o} - KR$$

By clearing fractions, transposing, and collecting terms:

$$(KR)R_o^2 - (KR^2 + (b-c))R_o + (bR) = 0$$

Solving for R_o by the quadratic formula:

$$R_o = \frac{(KR^2 + (b-c)) \pm \sqrt{(KR^2 + (b-c))^2 - 4(KR)(bR)}}{2(KR)}$$

■ 3. This formula can be simplified by finding the value of the following constants:

$$K = \frac{9}{7r} = 0.000000184637$$

$$F = KR$$

$$G = KR^2 = FR$$

$$J = (KR^2 + (b-c)) = G + (b-c)$$

Substituting these values in the quadratic, it becomes:

$$R_o = \frac{J \pm \sqrt{J^2 - 4Gb}}{2F}$$

■ 4. Notice that all the values used in computing the constants are independent of the height of tide with the exception of b and c . But since they will both change by the same amount, their difference is constant. R_o can then be found for the various heights of tide by substituting the corresponding values of b in the last equation. A chart or a table can then be made showing the relation between R_o and height of tide. The appropriate value of R_o is used as a setting on the range disk, as explained for the normal method in chapter 7.

APPENDIX IV

MANEUVERABILITY OF NAVAL VESSELS

■ 1. *a.* The purpose of this appendix is to present facts about the maneuverability and capabilities of naval vessels so that seacoast artillery personnel may better understand the problem of fire control.

b. The data contained herein pertain to the following types of naval vessels:

- Battleships (BB)
- Light cruisers (CL)
- Aircraft carriers (CV)
- Destroyers (DD)
- Submarines (SS)

c. It is recognized that variations will exist between vessels of the same type; nevertheless, an indication of the various maneuvering characteristics is presented.

■ 2. For various reasons, target practice conditions vary greatly from combat conditions. Targets likely to be confronted in battle are of high speed (exceeding 25 knots) and capable of sudden maneuvers. There are, however, certain facts pertaining to the maneuverability of naval vessels which will aid the plotter in prediction on this type of course. In addition, observers can be of considerable aid by transmitting directly to the plotter any change in bearing of the target. It must be remembered that in making a study of this kind, broad generalizations must be made. The validity of these generalizations can by no means be assured.

■ 3. *a.* Naval vessels do not respond instantaneously to a change in rudder. Because of this a vessel cannot change course by executing a "right face" or a "left face"; rather, the maneuver must begin by a gradual turn. The average rate of turn is about 1° a second.

b. When the rudder is put over, the ship begins to slip in a path which becomes approximately circular when the

FIRE CONTROL AND POSITION FINDING

ship has changed course by 90° . The term "course" refers to the instantaneous direction of motion of the foremast, that is, to the direction of the tangent to the turning path at the foremast. The foremast is assumed to be the center of pivot when turning. The bearing or ship's heading is the direction of the ship's centerline. It is therefore apparent that a change in bearing is not the same as a change

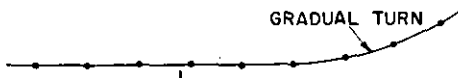

POINTS FALLING AS ABOVE
USUALLY INDICATE A CHANGE
IN THE COURSE OF THE TARGET.

FIGURE 158.—Change in course.

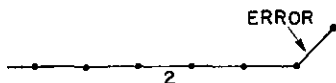

A POINT FALLING AS ABOVE
INDICATES THAT SOME ERROR WAS
MADE. A NORMAL VESSEL IS NOT
CAPABLE OF SUCH AN ABRUPT
MANEUVER.

FIGURE 159.—Error in course.

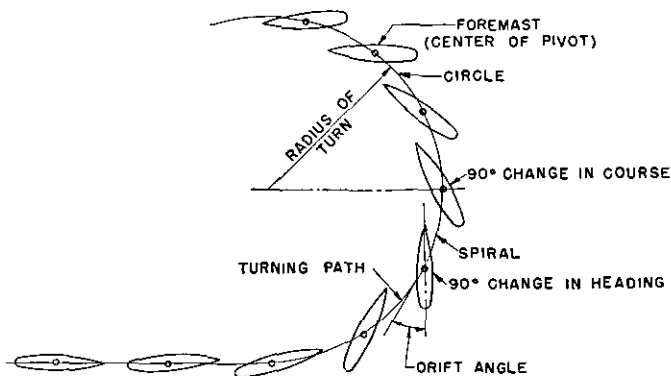

FIGURE. 160.—Successive positions of ship making 180° turn.

in course. The difference between the bearing and the course is a varying amount known as the drift angle. The average drift angle for a battleship is 10° ; that for a destroyer 5° (see fig. 161).

c. The after half of a ship responds most slowly to a change in course. Therefore, a certain amount of time is required for her stern to entirely clear the original course.

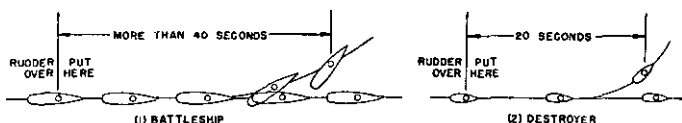
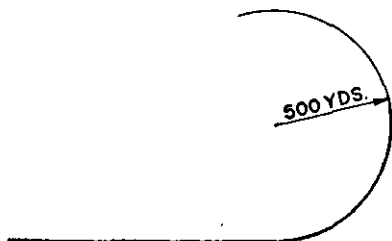

FIGURE 161.—Comparison of maneuverability of battleship and destroyer.

d. The radius in which a target may turn depends primarily on the rudder angle. The speed of approach of the large type ship has little effect on the radius of turn. The average radius of turn for battleships, cruisers, aircraft carriers, and destroyers is about 500 yards (see par. 4).



AVERAGE NORMAL TURN

FIGURE 162.—Average normal turn.

e. A maneuver greatly reduces the speed of a target. In fact, any change in rudder will cause a vessel to lose speed. A battleship may approach a curve at 26 knots, but after turning 180° (rudder angle 35°) the speed will be reduced to 12 knots. (For further comparisons see par. 4.)

f. On a continuous turn speed is lost only up to a certain change in course, after which there is no further reduction

FIRE CONTROL AND POSITION FINDING

In speed. For the change in course at which the speed becomes constant for the different types of naval vessels see the following tabulation:

Type of vessel	Battleship	Aircraft carrier	Cruiser	Destroyer
Speed constant after turning.....	360°	180°	90°	90°

g. The following points should be noted:

(1) Naval vessels are able to fire while maneuvering. The accuracy while maneuvering is slightly impaired but not to any great extent.

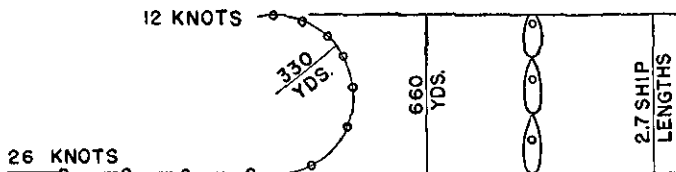

FIGURE 163.—Plotted points of battleship's turn (20-second intervals) to show reduction in speed of maneuvering target. Scale: 1 inch=800 yards.

NOTE.—A battleship may turn on a curve the diameter of which is only 2.7 ship lengths, but the resulting loss in speed is tremendous. In the above case the speed was reduced to less than half its former value.

(2) When fired upon, naval vessels invariably can be expected to maneuver. An evasive action commonly used is maneuvering into the splash to offset the effect of adjustment.

(3) After a maneuver has been completed, the vessel will continue on a straight course until another maneuver is ordered; that is, a vessel normally will not maneuver on a sinuous course except while on convoy duty.

(4) The evasive action of a submarine is to "crash dive." The average time to crash dive is only 35 seconds.

■ 4. a. Figure 164 illustrates the ability of the battleship to maneuver. The normal turns are plotted to scale for a particular approach speed and rudder angle. It should be

COAST ARTILLERY FIELD MANUAL

noted that naval vessels are able to change course by any amount, but only the time and speed for a change in course of 90° and 180° are shown on the diagrams. All maneuvers start at "0" on the order to the helmsman to lay over the rudder. In the figure open circles represent the probable positions of the foremast while the vessel is maneuvering. Solid circles represent the positions of the foremast *if the ship* had remained on the original course. The values indicated are average values only and variations will exist between vessels of the same class.

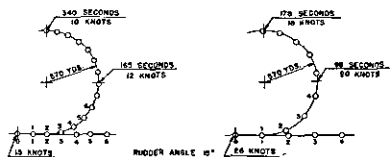

FIGURE 164.—Normal turns of an average battleship taken at 20-second intervals. Scale: 1 inch=800 yards.

b. The following table shows the ability of various types of naval vessels to maneuver. Data are shown for four differ-

1 Type	2 Approach speed knots	3 Rudder angle	4 R	90°		180°	
				Speed	Time	Speed	Time
				Battleship.....	15	15	570
		25	390	10	128	8	248
	26	15	570	20	98	18	178
		25	410	17	76	15	135
Cruiser.....	20	15	570	16	124	16	215
		25	350	14	95	14	170
	30	15	630	24	91	24	170
		25	400	21	76	21	130
Carrier.....	20	15	500	15	125	12	220
		30	380	12	108	11	190
	30	15	530	22	94	20	160
		30	410	21	78	18	130
Destroyer.....	25	25	350	21	60	21	105
		35	300	20	50	18	95
	34	25	500	29	55	29	100
		35	620	30	60	30	120

ent types of naval vessels at medium and high speeds with two different rudder angles for each speed. Column 4 gives the radius of turn for the initial speed and rudder angle shown in Columns 2 and 3. In Columns 5 and 6 are shown the speeds of the ships after they have changed direction by 90° and the number of seconds that have elapsed since the helm was thrown over. Columns 7 and 8 give the same data for a turn of 180° .

■ 5. a. A maneuver may be apparent to one of the observers in the position finding system before the trend of plotted points indicates the turn to the plotter. When a point falls off the course established by previous plotted points the plotter does not know whether the target is maneuvering or whether some error has been made. In determining the amount of any change in bearing of a ship, the observer should make use of bridges, breaks in the deck, or any other athwartship lines which will indicate the angular change in direction of travel. The opening or closing of the distance between masts, stacks, or turrets will also indicate changes in course. It is imperative that the observer inform the plotter immediately of any change in bearing of the vessel. Initially it is sufficient for the plotter to know only whether the target is turning to the right or to the left. Nevertheless, the observer should continue to inform the plotter of any change in bearing as the maneuver continues and indicate the final change in bearing when the vessel is again on a straight course.

b. When advice is received from an observer that the enemy vessel is maneuvering, the plotter should draw a smooth curve through the plotted points in the direction of the maneuver. The curve should be drawn with a radius of about 500 yards and of sufficient length to permit prediction. The normal method of prediction may be used, but a correction must be applied to compensate for the loss of speed while the target is maneuvering. This correction may be applied to the set-forward distance Y by using a constant factor of about 80 percent; that is, by multiplying the set-forward distance Y as received from the set-forward rule operator by 0.8. In order to locate the set-forward point to be used, pivot the prediction scale with the origin

about the last plotted point until the corrected set-forward distance intersects the curve. Continue to predict in a similar manner until the maneuver is completed. When the final change in course is indicated, draw a line tangent to the curve in the direction of the new course. Predict in the normal manner on the new course.

c. (1) Although a 500-yard radius of turning is more likely to occur than any other, the plotter must be prepared for more or less drastic maneuvers. Solution of the problem lies in intelligent application of knowledge of the previously described characteristics and limitations of maneuverability. The following plot illustrates an example of prediction

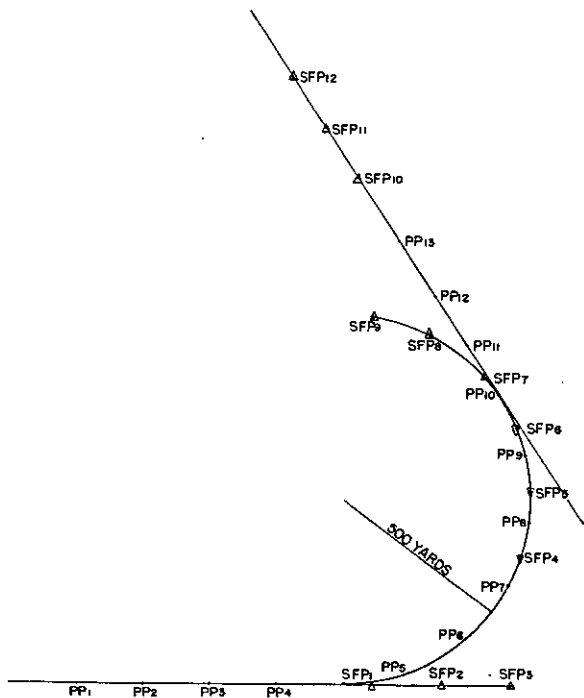

FIGURE 165.—Prediction on maneuvering course.

on a maneuvering course. This figure assumes a 155-mm battery firing at a destroyer at a range of about 10,000 yards. The speed of the target is 25 knots and the battery is using an observing interval of 15 seconds and a firing interval of 15 seconds.

(2) The following symbols are used: *pp* indicates a plotted point, *sfp* indicates a set-forward point; a suffix has been added to indicate a particular point.

d. (1) At *pp4* word is received from an observer that the vessel is turning to the left. Immediately the plotter draws a smooth curve through the plotted points with a radius of about 500 yards. The plotter places a prediction scale with the origin at *pp4* and measures back two plotted points to obtain the distance *X* traveled during the measuring interval *M*. In this case $X=42$. This value is sent to the set-forward rule operator and a set-forward distance of 70 is obtained. This value is multiplied by the set-forward factor of .8 to correct for the loss of speed while maneuvering. The corrected set-forward distance of 56 is obtained ($.8 \times 70 = 56$). The plotter then pivots the prediction scale about *pp4* until 56 intersects the curve. This locates *sfp4*. In a similar manner, *sfp5* to *sfp9* are determined.

(2) At *pp10* the observer informs the plotter that the maneuver has been completed and the final change in course is 130° . The plotter then draws a line tangent to the curve at an angle of 130° with the original course. The normal method of prediction is resumed on the new course. The curves may need slight modification as the maneuver progresses as indicated by the fall of plotted points.

APPENDIX V

THEORY OF DISPLACEMENT CORRECTOR, DEFLECTION BOARD M1

■ 1. The displacement corrector accomplishes an approximate graphical solution of the displacement problem and enables the corrected azimuth for a displaced point to be read directly.

■ 2. The displacement problem is illustrated in figure 166. X represents the directing point and G the position of a displaced gun for which the parallax correction is sought. The

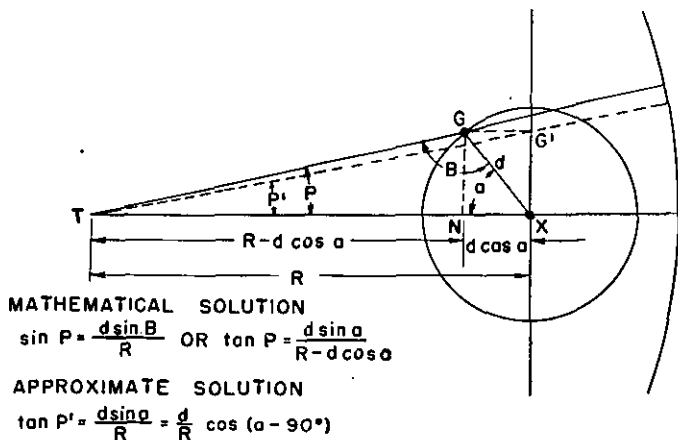

FIGURE 166.—Parallax problem No. 1.

displacement is the distance XG and is denoted as d . Let R denote the XT range. The parallax angle is denoted as P . Angles α and β are as indicated.

■ 3. It is evident that the parallax angle P depends on the range and the angle α (or β). In the triangle TXG by the law of sines:*

$$\sin P = \frac{d \sin B}{R} \quad (1)$$

■ 4. This is the exact mathematical solution and could be accomplished graphically if the set-up were duplicated to scale on the board. Since this is mechanically inconvenient an approximate solution giving the desired accuracy has been adopted.

■ 5. To obtain the approximate solution, line AB is drawn through X perpendicular to the XT line. A perpendicular is dropped from G to this line and point G' is thus projected onto the line, giving the point G' . The line TG' is drawn. This line gives a new parallax angle P' , which can be called the approximate parallax. Since the angle TXG' is 90° by construction, the angle $G'XG$ is $\alpha - 90^\circ$. In the right triangle, $G'XG$ the line may be expressed as follows:

$$G'X = d \cos (\alpha - 90^\circ) \quad (2)$$

In the triangle, $TG'X$:

$$\tan P' = \frac{G'X}{R} \quad (3)$$

Substituting in (3) the value of $G'X$ obtained in (2):

$$\tan P' = \frac{d \cos (\alpha - 90^\circ)}{R} \quad (4)$$

Since by a reduction formula, with any angle α :

$$\cos (\alpha - 90^\circ) = \sin \alpha \quad (5)$$

(4) can be converted into a more convenient form:

$$\tan P' = \frac{d \sin \alpha}{R} \quad (6)$$

■ 6. This is the mathematical formula expressing the approximate solution which is accomplished on the displacement corrector.

*By the law of sines, in any triangle with angles A , B , and C , and sides a , b , and c ,

$$\frac{\sin A}{a} = \frac{\sin B}{b} = \frac{\sin C}{c} \quad \text{Hence, } \sin A = a \frac{\sin B}{b}$$

which is identical with equation (6) for the approximate solution in another quadrant.

■ 10. From the last two equations we can obtain a formula representing the maximum error caused by adoption on the board of the approximate solution. For small angles of less than 2° , the angle expressed in radians is equal to the tangent of the angle itself. Therefore, angle P is equal to $\tan P$ and angle P' is equal to $\tan P'$, providing P and P' are expressed in radians. The error in parallax angle is equal to the difference between these two angles and, therefore, can be expressed as the difference in their tangents, thus:

$$\text{Error} = \tan P - \tan P'.$$

Consequently, subtracting (11) from (10) we obtain:

$$\begin{aligned} \text{Error} = \tan P - \tan P' &= \frac{d \sin \alpha}{R - d \cos \alpha} - \frac{d \sin \alpha}{R} \\ &= \frac{Rd \sin \alpha - (R - d \cos \alpha) (d \sin \alpha)}{R (R - d \cos \alpha)} \\ &= \frac{Rd \sin \alpha - Rd \sin \alpha + d^2 \sin \alpha \cos \alpha}{R (R - d \cos \alpha)} \\ &= \frac{d^2 \sin \alpha \cos \alpha}{R^2 - Rd \cos \alpha} \end{aligned} \quad (12)$$

■ 11. It can be proved that the error is maximum when $\alpha = 45^\circ$. Both the sine and cosine of 45° equal .70711.

Therefore
$$\text{Error} = \frac{d^2 (.50000)}{R^2 - .70711 Rd}$$

which becomes
$$\text{Error} = \frac{\frac{1}{2} d^2}{R^2 - .70711 Rd} \quad (13)$$

Since $.70711 Rd$ is very small compared with R^2 we may drop the term $.70711 Rd$ and obtain the expression:

$$\text{Error} = \frac{\frac{1}{2} d^2}{R^2} \text{ (in radians)} \quad (14)$$

$$\text{Error} = \frac{\frac{1}{2} d^2}{R^2} \times 57.3 \text{ degrees}$$

Example: For $R=10,000$ and $d=100$, the error = .0029°.

■ 12. Equation (14) gives a close approximation of the maximum error resulting from adoption of the approximate solution given in equations (6) and (11). For the different values of α , the error increases from zero at 0° to a maximum at 45° , then decreases to zero at 90° . Similarly, the error is maximum at 135° and zero at 180° .

■ 13. In figure 168, a displacement diagram has been superimposed on the board. The target is at the pintle of the

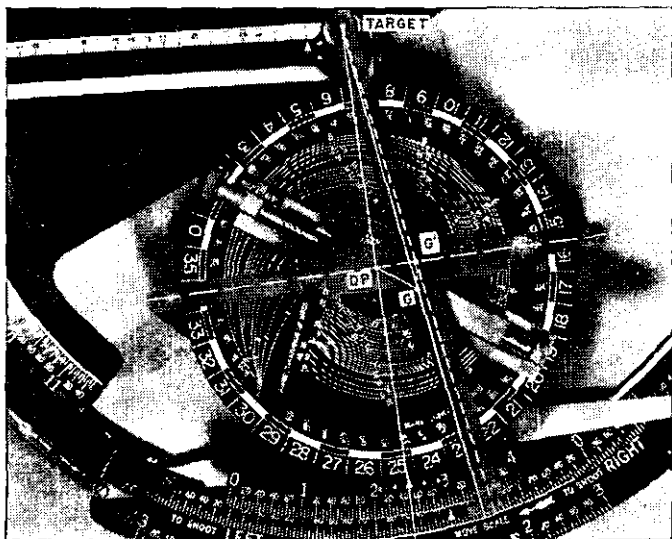

FIGURE 168.—Parallax problem superimposed on deflection board M1.

board and the DP is represented at the center of the displacement corrector shaft (center of curve disk). The line AB is represented by a fixed guide bar. The gun position is on the gun arm which is pivoted at the DP . G' is at the center of the pin on the top slide. The gun arm is set to the azimuth of the displaced gun from the directing point by means of its azimuth index and the auxiliary azimuth scale. When the gun arm setscrew is tightened, the gun arm is kept oriented by reason of its rotation with the auxiliary azimuth

scale which is geared to the main azimuth plate. Thus, the gun arm is rotated to duplicate the varying angle a . The rotary movement of G is communicated to G' through a double slide. The bottom slide is held perpendicular to the guide bar and slides over the pin representing G on the gun arm, while that on the top slides over the first one and is forced to move along the guide bar. The top slide carries a pin representing G' which is consequently given a reciprocating movement along the guide bar AB .

■ 14. Several complicating factors appear. They are—

a. The distance on the board between the pintle (target) and the center of the curve disk DP is constant, while on the ground this distance (range of the target from the DP) varies, thus causing corresponding variation in the parallax angle.

b. The azimuth for the displaced gun is read on the main azimuth scale, which is nine times greater than the auxiliary azimuth scale upon which the azimuth of the displaced gun is set.

c. The two range screws on the gun arm are constructed so that the range pointer moves twice as far as the pin on the gun arm.

■ 15. In figure 168, the displacement parallax diagram has been superimposed on the board. On the ground, the displacement is constant and the range varies, an increase in the range causing a decrease in parallax. Since the distance representing the range on the board is constant, the only way to effect a change in parallax is to change the distance representing the displacement XG (see fig. 166). To decrease the parallax, the distance XG must be reduced, therefore, an increase in range on the ground is taken care of by a decrease in the displacement distance. The curves are graduated to show the proper displacement distance on the board corresponding to any combination of range and displacement on the ground within the limits of the board. The curves are constructed for a condition in which G and G' (fig. 166) coincide. When the parallax is zero, G , and G' will both coincide with the directing point X . In order that the range pointer may be seen easily, it is constructed so that it always moves parallel to the gun arm and is always

$\frac{7}{8}$ -inch horizontally from the axis of the gun arm. Because of this the pointer will always move along lines tangent to a circle of $\frac{7}{8}$ -inch radius and concentric with the curve disk. For convenience in operation the gun arm is constructed so that the range pointer is at the outer edge of the curve disk when the above condition of zero parallax exists and, as point G moves away from X , the range pointer moves toward the center of the disk at twice the speed of point G . When G coincides with G' , the displaced gun is at right angles to the line XT , and, in this case, the parallax angle on the ground is found by the equation $\tan P = \frac{d}{R}$. Since the parallax is to

be read from the main azimuth scale which is constructed on a 9 to 1 ratio, the parallax angle on the board must be nine times the size of the parallax angle on the ground. On the board, the parallax angle $9P$ is found by the equation

$\tan 9P = \frac{XG'}{XT}$. The distance XT is fixed at 4.81 inches. Substituting this value, the above equation becomes $\tan 9P = \frac{XG'}{4.81}$

and solving for XG' , $XG' = 4.81 \times \tan 9P$. Since G coincides with G' this represents the distance of the point G from X . Since the range pointer moves twice as far as point G , its movement is found by doubling the value just found. The resulting movement is given by the equation $D = 9.62 \times \tan 9P$.

$$\tan P = \frac{d}{R}$$

$$P = \tan^{-1} \frac{d}{R} \quad \left(\text{Read } P = \text{the angle the tangent of} \right. \\ \left. \text{which is } \frac{d}{R} \right)$$

$$9P = 9 \left(\tan^{-1} \frac{d}{R} \right)$$

$$D = 9.62 \times \tan \left(9 \tan^{-1} \frac{d}{R} \right) \quad (15)$$

This last equation is used to plot the curves.

■ 16. Since the board is designed for a maximum parallax of 2° , the distance along tangent L from the point of tangency to the point of infinite range must represent 2° parallax. Hence $P = 2^\circ$. Equation (15) then becomes:

$$D = 9.62 \tan 18^\circ = 3.13 \text{ inches.}$$

- 17. Lay out the point of infinite range on the tangent at a distance of 3.13 inches from the point of tangency. Through this point draw the circle *U* with its center at *X*. The radius is found to be 3.25 inches by solving a right triangle, the legs of which are 3.13 inches and $.875$ ($\frac{7}{8}$) inch.
- 18. Lay out 50 more points each 6.9° from the previous point (the points will extend through 345° , leaving a 15° sector). The point where tangent *L* intersects circle *U* represents zero displacement and is so labeled. This point is the origin of all the range curves. The next point (clockwise) is 10, the next is 20, and so on. Draw lines through these points, tangent to inner circle. (See fig. 169.)

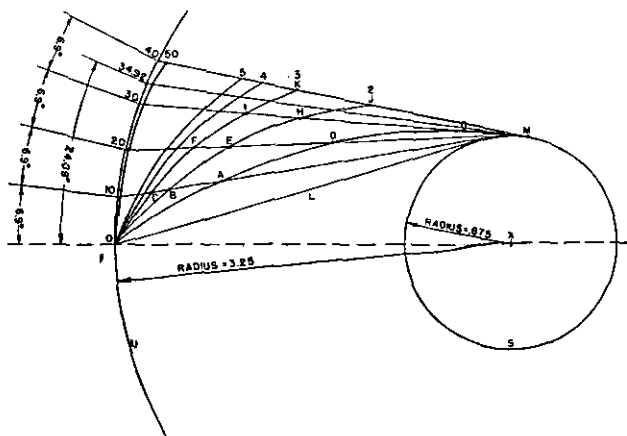

FIGURE 169.—Construction of displacement curves.

- 19. To graduate the tangents according to range, the angle α is taken equal to 90° , and the curves are plotted for this value. The same curves can be used for all values of α , since the mechanical movement of the gun arm for changes in α automatically multiplies the value of *D* by the $\sin \alpha$ (see equation (15)).
- 20. For displacements of 10, 20, 30, and 40 yards, values of *D* for various ranges from 1,000 to 50,000 yards have been calculated (see table I).

■ 21. Values of D for displacements from 40 to 500 yards can be calculated similarly and points of the same range when plotted can be joined by lines marked with the range in thousands of yards. See figures 168 and 169 for a view of the curves plotted on the curve disk. The parallax computed on the displacement corrector is algebraically added to the azimuth from the directing point on the main azimuth scale. The units and decimal parts of the corrected azimuth from the displaced point are read on the main azimuth scale at the outer end of the parallax arm, while tens and hundreds are read from the auxiliary scale.

■ 22. EXAMPLE.

Required.—The curve for 20,000 yards with points plotted for each 50-yard displacement from 0 to 500 yards.

Solution.—*a.* Draw concentric circles with radii of 0.875 inch and 3.25 inches.

b. From a point on the left side of the inner circle, draw a tangent downward, intersecting the outer circle. The length of this tangent will be 3.13 inches. The point where the tangent intersects the outer circle is labeled O .

c. Starting with point O and proceeding in a clockwise direction, lay off 10 equal arcs of 34.5° and, from each point so marked on the circumference of the outer circle, draw lines tangent to the inner circle similar to the one through point O . These points on the circumference are labeled 50, 100, 150, etc., in multiples of 50.

d. By means of formula (15), compute the value of D for a range of 20,000 yards and for displacements of every 50 yards from 0 to 500. The tabulation of these computations is shown in table 2.

e. Lay off the distances in column 6 along the proper tangents as shown in column 1, measuring all distances from the outer circle.

f. Connect the resulting points with a smooth curve which is the range curve for 20,000 yards. (See fig. 170.)

FIRE CONTROL AND POSITION FINDING

TABLE I

	Range (yards)	D (distance from circle of infinite range) (inches)	Corre- sponding points found in fig. 169
<i>d</i> = 10 yards	1,000	0.868	A
	2,000	.433	B
	3,000	.288	C
	4,000	.208	
	5,000	.172	
	50,000		
<i>d</i> = 20 yards	1,000	1.76	D
	2,000	.868	E
	3,000	.578	F
	4,000	.433	
	5,000	.347	
	50,000	.03	
<i>d</i> = 30 yards	1,000	2.66	G
	2,000	1.31	H
	3,000	.868	I
	4,000	.650	
	5,000	.519	
	50,000		
<i>d</i> = 40 yards	1,000	*3.02	
	2,000	1.76	J
	3,000	1.16	K
	4,000	.868	
	5,000	.694	
	50,000	.07	

*Since this distance is greater than the distance from the outer circle to the point of tangency, due to the fact that the parallax is more than 2° , it is not plotted. The value of the displacement *d* for which any range curve becomes tangent to the inner circle can be found by solving the equation $\frac{d}{R} = \tan 2^\circ$. The displacement for which the 1,000-yard curve touches the inner circle is found to be 34.92 yards. The angle corresponding to this displacement is found by the following formula:

$$\text{Angle} = d \times .69^\circ$$

Therefore, the angle corresponding to 34.92 yards is equal to $34.92 \times .69^\circ = 24.09^\circ$. This angle is laid off from point *O* in a clockwise direction to locate on the circumference of the outer circle the point corresponding to the displacement. The tangent is drawn through this point and the distance 3.13 inches is measured in along this tangent to locate the point of tangency *M*.

COAST ARTILLERY FIELD MANUAL

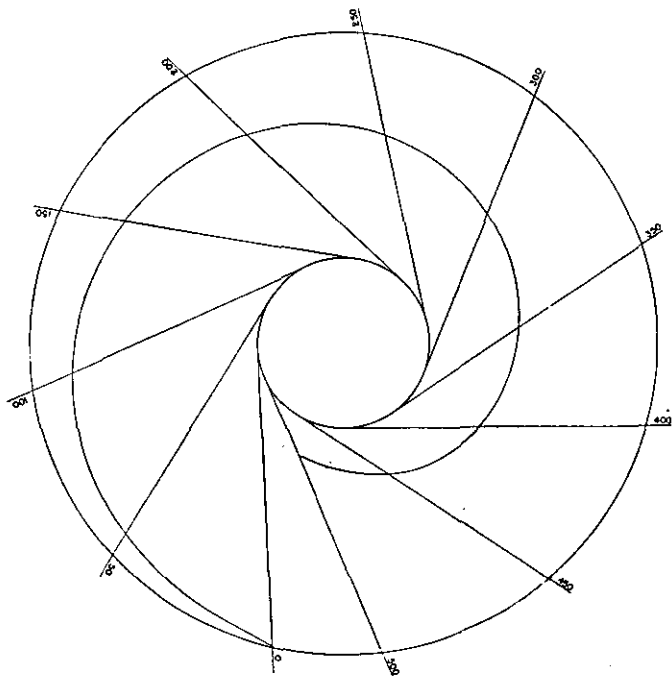

FIGURE 170.—Displacement corrector of deflection board M1, 20,000 yard range curve.

FIRE CONTROL AND POSITION FINDING

TABLE II

$D=0.62 \tan \left(9 \tan^{-1} \frac{d}{R} \right)$				$R=20,000$	
1 d	2 $\frac{d}{R}$	3 $\tan^{-1} \frac{d}{R}$	4 $9 \tan^{-1} \frac{d}{R}$	5 $\tan \left(9 \tan^{-1} \frac{d}{R} \right)$	6 $\frac{0.62 \tan \left(9 \tan^{-1} \frac{d}{R} \right)}{R}$
0	0	0	0	0	0
50	.0025	9'	1° 21'	.0236	.23
100	.0050	17'	2° 33'	.0445	.43
150	.0075	26'	3° 54'	.0682	.66
200	.0100	34'	5° 00'	.0892	.86
250	.0125	43'	6° 27'	.1131	1.09
300	.0150	52'	7° 48'	.1370	1.32
350	.0175	1° 00'	9° 00'	.1584	1.52
400	.0200	1° 09'	10° 21'	.1826	1.76
450	.0225	1° 17'	11° 33'	.2044	1.97
500	.0250	1° 26'	12° 54'	.2290	2.20

APPENDIX VI

CONSTRUCTION OF CHARTS AND SCALES FOR SEACOAST ARTILLERY FIRE CONTROL INSTRUMENTS

■ 1. GENERAL.—*a.* Many of the present fire control instruments for seacoast artillery contain charts or scales for the graphical solution of the various problems that arise in position finding and in the determination of firing data. This appendix explains the construction of these charts and scales so that when necessary their accuracy may be verified or new charts or scales constructed.

b. A graphical scale is a line either straight or curved, on which is marked a series of systematically spaced graduations corresponding to a set of numbers. The system used in the spacing of the graduations determines whether the scale is uniform or nonuniform. When the system of graduations is such that the distances between graduations are directly proportional to the differences in the numbers corresponding to those graduations, the scale is uniform. If the distances between graduations are not directly proportional, the scale is nonuniform. A uniform scale can be used to measure distances (the surveying tape), or, in combination with another similarly plotted scale, to add quantities together (the lateral adjustment scale on the universal deflection board).

■ 2. UNIFORM SCALE.—*a.* Let AB (fig. 171) be a straight line of indefinite length and let the point O represent the origin from which the construction of the scale will begin.

b. Select a unit of length MN and assume that the lengths measured from O to the right are positive and those to the left negative. Then if $X=+3$, locate the point X on the scale AB by measuring three unit lengths to the right from O . Similarly, if $X'=-3$, find the point X' on the scale by measuring three unit lengths to the left from O .

c. The unit length selected should be of such size that no two subdivisions of the scale are less than 0.04 inch apart;

that is, there should never be more than 25 graduations to each inch of the scale in order that it may be used readily. In a great many cases, it will be convenient to have fewer divisions per inch of the scale.

Example: Plot a uniform range scale at a scale of 500 yards to the inch. (See fig. 171.) Draw the straight line *AB*. Let

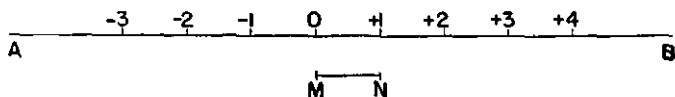

FIGURE 171.—Uniform scale.

the origin fall at *O*. This point should then be marked zero. One inch to the right of *O*, according to the selected unit length, will then represent a range of 500 yards and should be marked correspondingly. The divisions for 1,000, 1,500, 2,000, 2,500, and 3,000 yards should be placed at distances of 2, 3, 4, 5, and 6 inches from *O*, respectively. The intermediate graduations between the points *O* and 500 yards are located in the same manner; namely, the division for 50 yards is 0.1 inch to the right of *O*, for 100 yards it is 0.2 inch, and so forth. No attempt should be made to construct this scale with graduations representing less than 20 yards. Frequently, more satisfactory results will be obtained by making the least graduation 50 yards.

d. Uniform scales frequently are constructed on the arcs of circles. Typical examples of these scales are the azimuth circles of guns, plotting boards, and azimuth instruments. The unit of measurement for the graduation of circular uniform scales may be a unit of length measured along the arc of the circle, but it is more frequently an angular unit. On the azimuth circle of a gun the unit of graduation and the unit of marking are the same, that is, 1° . On the ordinary clock dial the unit of graduation and the unit of marking are not the same, as 6° represent 1 minute of time.

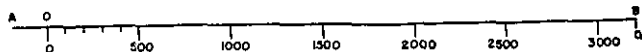

FIGURE 172.—Uniform range scale.

■ 3. NONUNIFORM SCALE.—*a.* It is often convenient to construct a scale uniformly with respect to one variable and then to mark it in terms of a second variable which is the function of the first. If the second variable is not directly proportional to the first, the scale then becomes a nonuniform scale. For example, on the wind and drift charts of the M1 deflection board, the time of flight scale on the side of the chart is an example of this type of nonuniform scale. The chart for the 6-inch seacoast gun M1903A2, firing shot AP Mk. XXXIII with fuze BD M60, Firing Tables 6-E-2, contains two scales, one showing elevation in mils and the other time of flight in seconds. The first is a uniform scale and the second a nonuniform scale. The data for constructing a portion of the second scale is given below. Column 1 gives the time of flight, column 2 gives the corresponding elevation, and column 3 gives the scale distance in inches from the origin. The scale factor is 1 inch=80 mils. Column 3 is found by multiplying the numbers in column 2 by .0125 inch.

1	2	3
Time of flight (seconds)	Elevation (mils)	Scale distance (1 inch=80 mils) (.0125 inch=1 mil)
0	0	0
5	30.4	.39
10	62.6	.78
15	97.8	1.22
20	135.2	1.69
25	175.7	2.20

b. The time of flight scale can be constructed in either of two ways:

(1) By laying off the distances in column 3 and marking them with the corresponding numbers in column 1.

(2) By first laying off the uniform elevation scale. Opposite the graduations corresponding to the numbers in column 2 mark and label the graduations corresponding to the numbers in column 1. (See fig. 173.)

c. Other typical nonuniform scales are the range-elevation scales on some universal deflection board charts. These are constructed on a uniform scale of ranges but with elevations shown for the corresponding ranges.

d. Like the uniform scales, nonuniform scales may be constructed equally well on straight lines or on arcs. Examples of nonuniform scales on arcs are the scales of circular slide rules and scales of range disks the graduations of which are on the periphery. In the latter case the ranges are marked on the range disks in place of the corresponding quadrant elevations at which the piece is pointed. The range disk thus acts as a range-elevation relation scale.

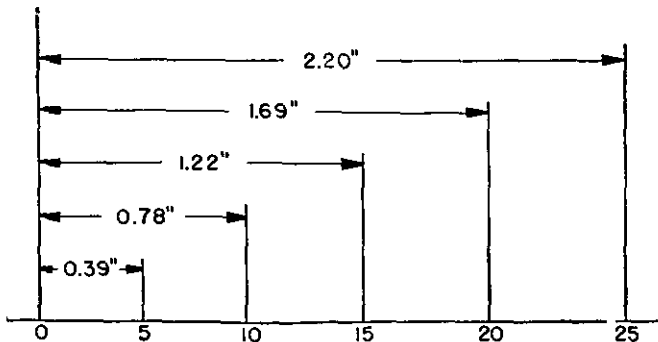

FIGURE 173.—Construction of nonuniform scale.

■ 4. LOGARITHMIC SCALE.—a. A logarithmic scale is a special type of nonuniform scale which is graduated in terms of the logarithm of the variable with which it is marked. In constructing a logarithmic scale, use is made of what is called a logarithmic unit which is equal to the logarithm of 10. In plotting a logarithmic scale, it is necessary to select some distance to represent one logarithmic unit. This distance is called the scale factor. Therefore, the distance between any two numbers the logarithms of which differ by one (for example, between 1 and 10, or between 100 and 1,000) must be equal to the scale factor.

Example.—It is desired to construct a logarithmic scale of numbers from 2.5 to 7.5, using a scale factor of 15 inches

equals 1 logarithmic unit. The following tabulation gives the information necessary to construct such a scale. Column 1 contains the numbers. Column 2 contains the corresponding logarithms obtained from logarithmic tables. Column 3 contains the scale distances obtained by multiplying the numbers in column 2 by the scale factor. The scale distance in column 3 could be used to lay out the scale if the graduation for the number in column 1 is located on the paper. However, since this scale is assumed to start at 2.5, it is necessary to subtract the scale distance for 2.5 from each of the other distances listed in column 3. The results of these subtractions are listed in column 4.

1 Numbers	2 Logarithms of numbers in column 1	3 Logarithms in column 2 \times scale factor	4 Scale distance in inches from 2.5 graduation
2.5	0.39794	5.96910	0
3.0	.47712	7.15680	1.18770
3.5	.54407	8.16105	2.19195
4.0	.60206	9.03090	3.06180
4.5	.65321	9.79795	3.82885
5.0	.69897	10.48455	4.51545
5.5	.74036	11.10540	5.13630
6.0	.77815	11.67225	5.70315
6.5	.81291	12.19365	6.22455
7.0	.84510	12.67650	6.70740
7.5	.87506	13.12590	7.15680

b. Selecting an origin *O* on a straight line *AB*, lay off the distances shown in column 4 to the right from *O* and label the graduations with the corresponding numbers in column 1. Intermediate points on the scale can be located in this manner.

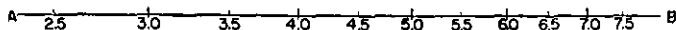

FIGURE 174.—Construction of logarithmic scale.

c. Such a logarithmic scale is obviously a nonuniform scale. This type of scale is frequently encountered in fire control equipment, since by graphical addition of the log-

arithms of any two quantities shown on such scales their product is obtained. The scales of an ordinary slide rule are of this type.

■ 5. DEFINITION OF CHART.—The term “chart” as used in this manual signifies a drawing or diagram by means of which graphical solutions are made. A chart differs from a scale in that the latter has only one dimension, namely, length, while charts have two dimensions, length and breadth. From a scale we may determine a quantity which depends upon one variable only, while from a chart we may determine quantities which depend on two separate variables. For example, from a range-elevation scale we may determine the elevation corresponding to any selected range, but from the chart of a range correction board we may determine the different range corrections required for a given muzzle velocity at any selected range.

■ 6. RECTANGULAR COORDINATES.—In figure 175, let XX' be a horizontal straight line and let YY' be a straight line

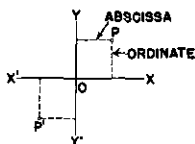

FIGURE 175.—Rectangular coordinates.

perpendicular to XX' at the point O . Any point in the plane is determined by its perpendicular distance from each of the lines XX' and YY' . The distance from any point P to YY' is measured parallel to XX' and is called the “abscissa” of the point P . Similarly, the distance from P to XX' is measured parallel to YY' and is called the “ordinate” of the point P . Together the abscissa and ordinate of P determine its location, and they are called “coordinates” of that point. The point O is called the “origin.” All points to the right of O have positive abscissas measured along the XX' axis and parallel to it, and all points to the left have negative abscissas measured along the XX' axis and parallel to it. All points above O have positive ordinates

measured along the YY' axis and parallel to it and those below have negative ordinates measured along the YY' axis and parallel to it. Thus, the points P and P' may have the same absolute values for their abscissas and ordinates, but the coordinates of P are both positive while those of P' are both negative.

■ 7. CONSTRUCTION OF CHART USING RECTANGULAR COORDINATES.—*a.* If it is desired to construct a chart from which it is possible to determine graphically the effect in range due to changes in muzzle velocity for a certain gun, projectile, and powder charge, such a chart would in effect be a section of a range correction board chart. The appropriate firing tables contain the following data:

EFFECT IN YARDS OF RANGE DUE TO INCREASE IN MUZZLE VELOCITY

Range (yards)	Increase in muzzle velocity (feet per second)			
	20	40	60	80
	Effects in yards of range			
2,000.....	33	66	98	132
4,000.....	65	130	194	259
6,000.....	96	191	287	383
8,000.....	125	250	374	500
10,000.....	152	303	455	607

b. Figure 176 shows one solution of the problem of representing graphically the data listed in the foregoing table. The range effects have been plotted as abscissas and the ranges as ordinates. The unit of measure chosen for the abscissa scale (X axis) is 1 inch equals 100 yards. The ordinate scale (Y axis) chosen is 1 inch equals 2,000 yards. Each curve showing the range effects at varying ranges for a selected increase in muzzle velocity is plotted in turn. For example, in plotting the curve for an increase in muzzle velocity of 20 foot-seconds, the first point is plotted with an abscissa (range effect) of 0.33 inch (33 yards) and an ordinate of 1 inch (2,000 yards); the next point is plotted with an abscissa of 0.65 inch (65 yards) and an ordinate

of 2 inches (4,000 yards). When all the points of this curve have been plotted, it will be found that they do not lie along a straight line, but when connected they form a curve which is slightly concave toward the Y axis. In such a case, when connecting the points by a single line, the curve should be made smooth and should be drawn as nearly as possible through all points. It is therefore the best representative line of quantities being plotted, and any single point lying at a distance on either side of the line will usually be the result of an error in plotting or an error in the data used in plotting. A glance at the completed chart shows the ease and rapidity with which the range effect for any change in muzzle velocity at any range may be determined graphically. For example, 20 foot-seconds' change in muzzle velocity at 9,000 yards will result in a range change of 140 yards; by interpolation between curves, 30 foot-seconds' change in muzzle velocity at 8,400 yards will result in a range change of 197 yards, and so forth. Other solutions of this problem may be obtained by using different units of measure in the abscissa and ordinate scales or by plotting different values as abscissa and ordinate.

c. From the foregoing discussion it is evident that there are several possible solutions for each problem in plotting.

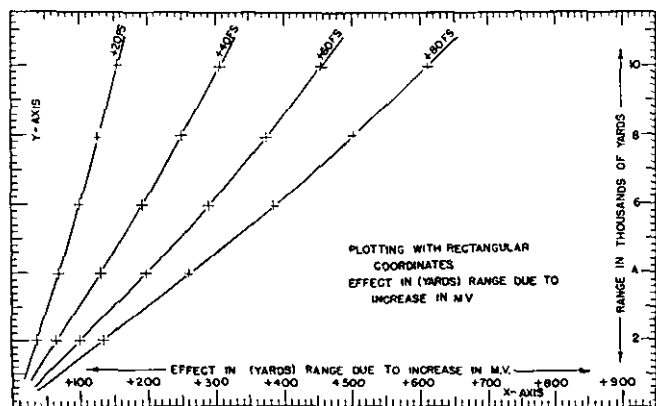

FIGURE 176.—Section of muzzle velocity effect curves with like rectangular coordinates.

The following points should be considered before commencing to plot:

(1) The accuracy required in the solutions to be obtained from the chart.

(2) The limiting (usually the maximum) size of the chart.

(3) The range of values which must be plotted.

d. With (1), (2), and (3) above in mind, the size of the scales used for abscissas and ordinates may be selected. When choosing these scales, it is permissible and usually desirable to have the scale of abscissas different from the scale of ordinates.

■ 8. POLAR COORDINATES.—*a.* Given any fixed point O , called the "pole," and any fixed line OA , passing through O and called the "polar axis," the location of any point P with respect to O may be determined by its distance from O ; that is, OP , and by the size of the angle AOP made by the intersection of the line OP with the polar axis OA . The distance OP is commonly called the "radius vector," and the angle AOP is called the "vectorial angle." Together, these quantities, an angle and a distance, are called the "polar coordinates" of the selected point. The vectorial angle can be increased by rotating either in a clockwise or a counterclockwise direction from the polar axis. It is evident that every pair of numbers representing respectively, a radius and a vectorial angle, determines a single point. This may be plotted as follows:

(1) Construct the terminal line of the vectorial angle by laying off with a protractor the vectorial angle with zero of the protractor held on the polar axis (initial line) and the center of the protractor at the pole.

(2) With a rule laid along the terminal line, plot the point

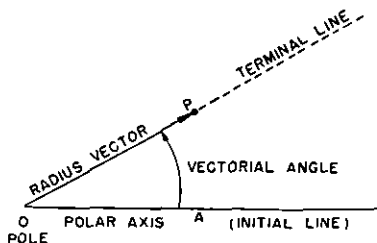

FIGURE 177.—Polar coordinates.

at the given distance from the pole establishing the radius vector.

b. The 110° plotting board illustrates clearly the use of polar coordinates. The data for determining each set-forward point on the 110° plotting board, namely its range and azimuth, constitute the polar coordinates of that set-forward point. The pole O on the 110° plotting board is the directing point. The polar axis is the line of zero azimuth through the directing point. The range in yards from the directing point to the set-forward point represents the radius vector, while the azimuth of the set-forward point measured from the directing point represents the vectorial angle. In coast artillery, azimuth is always measured in a clockwise direction from a polar axis (in this case, the south-end of a north-south line).

■ 9. CONSTRUCTION OF CHART USING POLAR COORDINATES.—Every plot of the course of a target that is made on a plotting board when a single station (DPF or radar) system of range finding is used illustrates chart construction with polar coordinates. The pole is the single station. The polar axis is the line of zero azimuth from this station. The radius vectors of the several plotted points along the course are measured ranges to the target, and the vectorial angles are the corresponding target azimuths. In the determination of wind velocities for the preparation of meteorological messages, the horizontal projection of the balloon's path is plotted by polar coordinates.

■ 10. RANGE-ELEVATION SCALE FOR PERCENTAGE CORRECTOR M1.—a. The purpose of a range-elevation scale used on a percentage corrector is two-fold. It must provide means not only for converting ranges into elevations for use in pointing a gun but also for applying percentage corrections to the ranges before conversion. Therefore, the range scale, which is the basic scale in this case, must be logarithmic. The elevation scale, which is the secondary scale in this case, consists of markings in terms of elevations placed opposite the corresponding ranges.

Example: It is desired to construct a section of the range-elevation scales for a 155-mm gun M1917, firing shell M101 equipped with PD fuze M51A1, charge normal, ranges be-

COAST ARTILLERY FIELD MANUAL

tween 13,500 and 14,600 yards, using a scale of 1 log unit equals 200 inches. The data contained in columns 1 and 2 of the following table were extracted from the appropriate firing tables (Firing Tables 155-U-1).

COMPUTATION OF DATA FOR RANGE-ELEVATION SCALE

1	2	3	4	5
Range (yards)	Elevation (mils)	Log range	Log range— log 13,500	Scale distance (inches) (column 4 x 200)
13,500	422.2	4.13033	0.00000	0
13,600	428.4	4.13354	.00321	.642
13,700	434.6	4.13672	.00639	1.273
13,800	440.8	4.13988	.00955	1.910
13,900	447.0	4.14301	.01268	2.536
14,000	453.4	4.14613	.01580	3.160
14,100	460.0	4.14922	.01889	3.778
14,200	466.6	4.15229	.02196	4.392
14,300	473.4	4.15534	.02501	5.002
14,400	480.2	4.15836	.02803	5.606
14,500	487.2	4.16137	.03104	6.208
14,600	494.4	4.16435	.03402	6.804

b. The 100-yard graduations of the range scale are plotted by measuring the distances tabulated in column 5 from any selected point marked 13,500. The graduations for each 20 yards of range may be plotted by straight interpolation between each 100-yard mark with sufficient accuracy for practical purposes. The 5-mil markings for the elevation scale must now be fitted by interpolation onto the scale in their proper relation between columns 1 and 2.

c. A graphical method of interpolation will be illustrated. From the range-elevation relation shown in columns 1 and 2 a curve may be plotted, as shown in figure 178, using ranges as abscissas and elevations as ordinates. Ranges should be shown to the nearest 10 yards and elevations to the nearest 0.1 mil but, because of lack of space, they are less exact in the figure. From such a curve, the range corresponding to any desired elevation may be read and the elevation marking placed opposite that range on the scale. For example, the elevation marking for 510 mils should be placed opposite the

FIRE CONTROL AND POSITION FINDING

range of 13,720 yards and that for 560 mils opposite the range of 14,285 yards. Figure 178 could be used for the location of all points on the elevation scale but such accuracy is unnecessary. After the markings for each multiple of 5 mils have been located, those for the intervening mils, to the nearest mil, may be put in by straight interpolation between the 5-mil marks.

d. When more than one type of projectile or powder

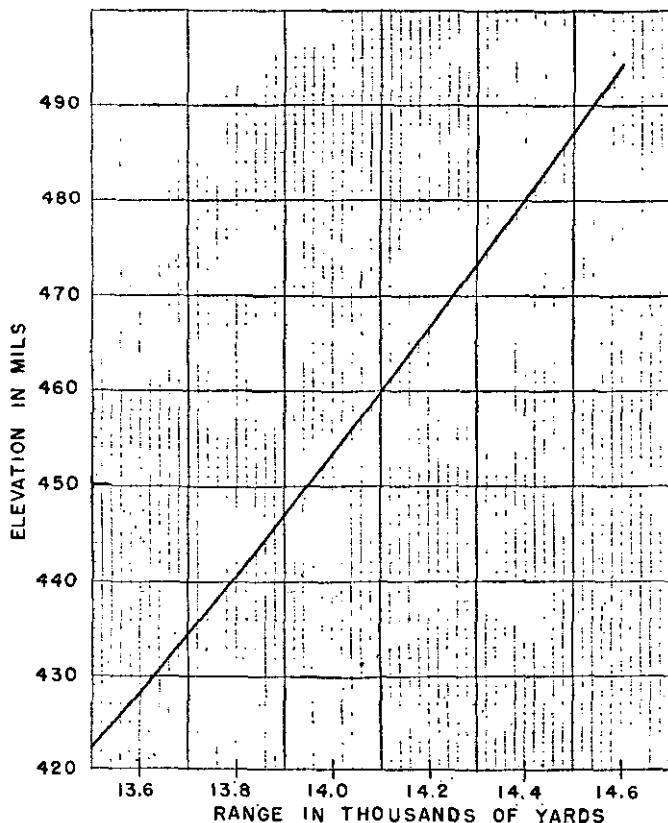

FIGURE 178.—Range-elevation curve.

charge is used, additional elevation scales must be constructed, using the same basic range scale. Some range-elevation tapes for a 155-mm gun, for instance, have an elevation scale for use when firing with the normal charge and another for use when firing with the supercharge.

■ 11. GRADUATION OF RANGE DISK.—*a.* Some fixed seacoast guns are still laid in elevation by means of a range disk whose readings are corrected for height of site. In these cases, ordnance personnel graduate the range disk when it is on the gun, according to a tabulation made from the firing tables. The method is given here in order that the instruction given in the following paragraph regarding the construction of range-range relation scales may be better understood.

b. Consider the following tabulation made for the 12-inch seacoast gun M1895 on 12-inch barbette carriage M1917, firing the 870-pound projectile from a height of site of 100 feet (Firing Table 12-L-4):

Map range (yards)	Height of site correction	Corrected range (yards)	Corresponding elevation (degrees)
9,000	-283	8,717	5° 16'
9,200	-272	8,926	5° 25'
9,400	-265	9,135	5° 47'

NOTE.—Elevations are given in degrees and minutes here so that the clinometer can be used to graduate the range disk and to check the range disk setting.

c. To graduate the range disk for 9,000 yards range, the gun is elevated to exactly 5° 16' as indicated by a clinometer, and opposite the index on the range disk a graduation is marked and labeled 9,000. Similarly, the 9,200 and 9,400 graduations are marked on the range disk when the gun is at 5° 25' and 5° 47' elevation, respectively. The tabulation is extended and the procedure continued until the disk is graduated from minimum to maximum range.

d. The use of the range disk so graduated is simple. Corrected range from the percentage corrector is sent to the gun and set directly on the range disk. The problem is

complicated, however, if the gun has different types of ammunition with different range-elevation relationships. For convenience, the ammunition for which the range disk is graduated is called "standard," and the other type of ammunition fired by the gun is called "nonstandard." It is evident that the range disk graduated above could not be used without correction when the gun is to fire a nonstandard projectile which will attain a range different from 9,000 yards if fired at $5^{\circ} 16'$. In some cases guns have a range disk for each projectile, fuze, muzzle velocity, and height of site. When a change of ammunition is ordered, the range disks are changed accordingly. In other cases, a gun using different types of ammunition is furnished with only one range disk. The problem of properly pointing such a gun in elevation when firing an ammunition different from that for which the range disk is graduated is solved by using a special tape known as a range-range relation tape in the percentage corrector. This special tape differs from a standard range-elevation scale only in the fact that elevations at which the gun is to be set are shown on the tape in terms of range. These range readings indicate the range settings on the range disks which will produce the desired quadrant elevations.

■ 12. CONSTRUCTION OF RANGE-RANGE RELATION TAPE.—*a.* The range-range relation tape consists of two range scales. One range scale may be considered as the range-to-target scale. It is an ordinary range scale, constructed logarithmically (as described for the basic range scale, par. 4) in order that ballistic and adjustment corrections may be applied as percentages. The read scale consists of settings to which the range disk must be turned in order to lay the gun at the quadrant elevations corresponding to the ranges on the range-to-target scale; it is not a logarithmic scale, since the divisions are not located according to that law, and percentage corrections must be applied to the first scale before conversion.

b. (1) The first step in construction is the computation from the firing tables of the relationship existing between the ranges (corrected for height of site) for the two combinations of projectile and powder charge. This process is illustrated in the following tabulation:

COAST ARTILLERY FIELD MANUAL

COMPUTATION FOR THE RANGE-RANGE RELATION TAPE

(12-inch seacoast gun, M1895, on 12-inch barbette carriage, M1917; height of site, 100 feet; range disks graduated for 870-pound AP projectile (Firing Tables 12-L-4); nonstandard ammunition, 975-pound AP projectile (Firing Tables 12-F-3))

1	Nonstandard ammunition			Standard ammunition			Nonstandard ammunition	
	2	3	4	5	6	7		
Map range (yards)	Correction for height of site (yards)	Corrected range (yards)	Corresponding elevation (mils)	Correction for height of site (yards)	Corrected range (yards)	Corresponding elevation (mils)	Ranges that will be attained with the nonstandard ammunition when the range disk is set to value given in column 1	
9,000	274	8,726	100.0	283	8,717	93.6	8 Ranges that will be attained with the nonstandard ammunition when the range disk is set to value given in column 1	
9,500	254	9,246	107.2	261	9,239	100.7		
10,000	236	9,764	114.5	241	9,759	107.8		
10,500	220	10,280	122.1	223	10,277	115.2		
11,000	205	10,795	129.7	207	10,793	122.7		
11,500	192	11,308	137.5	192	11,308	130.5		
12,000	179	11,821	145.5	179	11,821	138.5		
Source	Part 2, table B, FT 12-F-3.	Column 1 minus column 2.	Part 2, table A, FT 12-F-3.	Part 2, table B, FT 12-L-4.	Column 1 minus column 5.	Part 2, table A, FT 12-L-4.		Interpolation between columns 1 and 4.

Note.—Firing tables show elevations in degrees and minutes as well as in mils and tenths of mils. Computation in mils and tenths of mils is preferable.

FIRE CONTROL AND POSITION FINDING

(2) Column 1 represents the map range to the target. Columns 3 and 6 represent the range corrected for height of site for the two types of ammunition, and columns 4 and 7 represent the elevations corresponding to these corrected ranges. In addition, column 7 shows the quadrant elevation at which the gun will be pointed when the range disk is set to the value shown in column 1. The range attained with nonstandard ammunition when the gun is set at the elevation shown in column 7 is found by interpolating in columns 4 and 1. For example, if the range disk is set at 9,500 yards the corresponding quadrant elevation will be 100.7 mils. Therefore, the actual range attained is 9,050 yards and is found by interpolating 100.7 between 100.0 and 107.2 in column 4 to get the value of 9,050 between 9,000 and 9,500 in column 1. This value is marked in column 8 opposite 100.7 in column 7. The other values are found by the same method. Thus, for the range disk settings shown in column 1, the corresponding ranges attainable with nonstandard ammunition are shown in column 8.

(3) The logarithmic range scale can be considered as the range-to-target scale. The range disk reading scale is plotted beside the range-to-target scale in the following manner: On the logarithmic scale find the graduation corresponding to the range shown in column 8. Opposite this graduation plot a graduation and label it with the range shown in column 1. The entire table is completed, but only a comparatively few graduations, perhaps those at each 500 yards, must be calculated and plotted as explained. The intermediate graduations of the range disk scale may be conveniently plotted by use of a log scale that already has been constructed. Move the log scale along the range-range relation scale until the proper number of graduations are intercepted and plot the graduations accordingly. For instance, between the 9,500-yard graduation and the 10,000-yard graduation there should be twenty-four 20-yard graduations.

(4) The range-range relation tape is used on the percentage corrector in the same manner as the range-elevation tape. Uncorrected ranges from the plotting board are set on the logarithmic range scale. After corrections from the

COAST ARTILLERY FIELD MANUAL

range correction and fire adjustment boards have been applied, the proper range disk setting is read from the range disk scale opposite the read pointer and sent to the guns.

c. *Graphical solution.*—(1) The range-range relation can also be determined by graphical means. Assume that a bat-

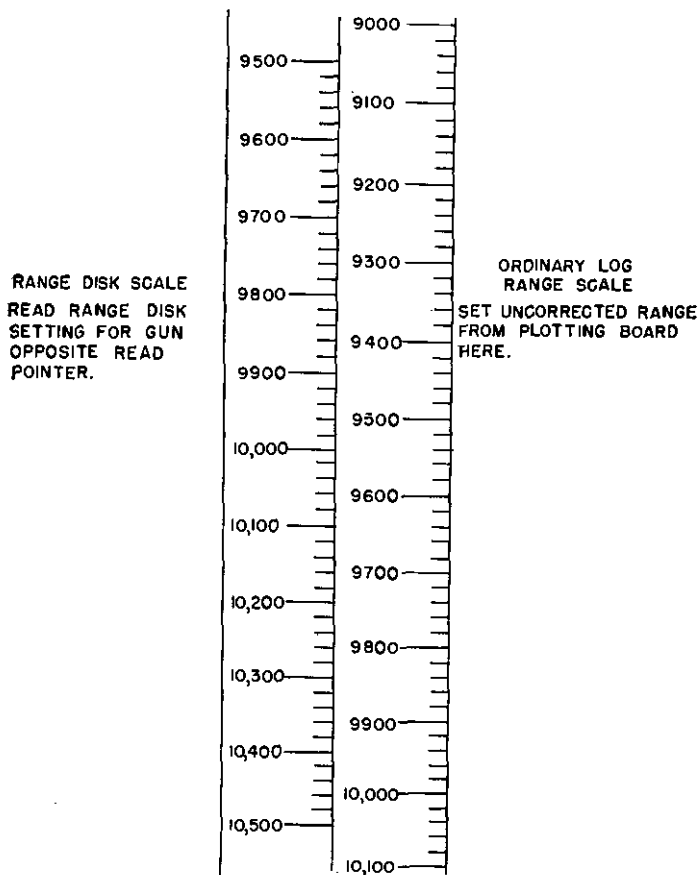

FIGURE 179.—Range-range relation tape (par. 12b).

FIRE CONTROL AND POSITION FINDING

tery of 12-inch seacoast guns mounted on barbette carriages M1917, 100 feet above sea level, is furnished with 975-pound AP projectiles (Firing Tables 12-F-3 and 1,070-pound AP projectiles (Firing Tables 12-K-2), but is equipped with range disks for 1,070-pound projectiles. The illustration given here covers map ranges between 9,000 and 10,000 yards with corrected ranges and elevations in mils computed for every 100 yards of map range. The height of site corrections are taken from the appropriate firing tables and the corresponding level point ranges and elevations are determined as before. The map range-elevation relation curve for each type of ammunition is plotted as shown in figure 180. The following is a table of data computed from the firing tables.

Standard (firing tables 12-K-2)				Nonstandard (firing tables 12-F-3)		
1	2	3	4	5	6	7
Map range (yards)	Correc-tion for height of site (yards)	Corrected range	Corre-sponding elevation (mils)	Correc-tion for height of site (yards)	Corrected range (yards)	Corre-sponding elevation (mils)
9,000	270	8,730	103.0	274	8,726	100.0
9,100	266	8,834	104.5	270	8,830	101.4
9,200	262	8,938	105.9	266	8,934	102.9
9,300	257	9,043	107.4	262	9,038	104.3
9,400	253	9,147	109.1	258	9,142	105.8
9,500	249	9,251	110.6	254	9,246	107.2
9,600	245	9,355	112.0	250	9,350	108.7
9,700	242	9,458	113.7	247	9,453	110.1
9,800	238	9,562	115.1	243	9,557	111.6
9,900	235	9,665	116.6	240	9,660	113.0
10,000	231	9,769	118.2	236	9,764	114.5

(2) In figure 180, the horizontal scale is graduated in ranges from 9,000 to 10,000 yards. The vertical scale is graduated in mils of elevation from 100 to 120. The elevations are plotted against the corresponding map ranges and these points are connected by a smooth curve. The curve lettered *B* represents the curve for nonstandard ammunition which was plotted from columns 1 and 7. The curve lettered

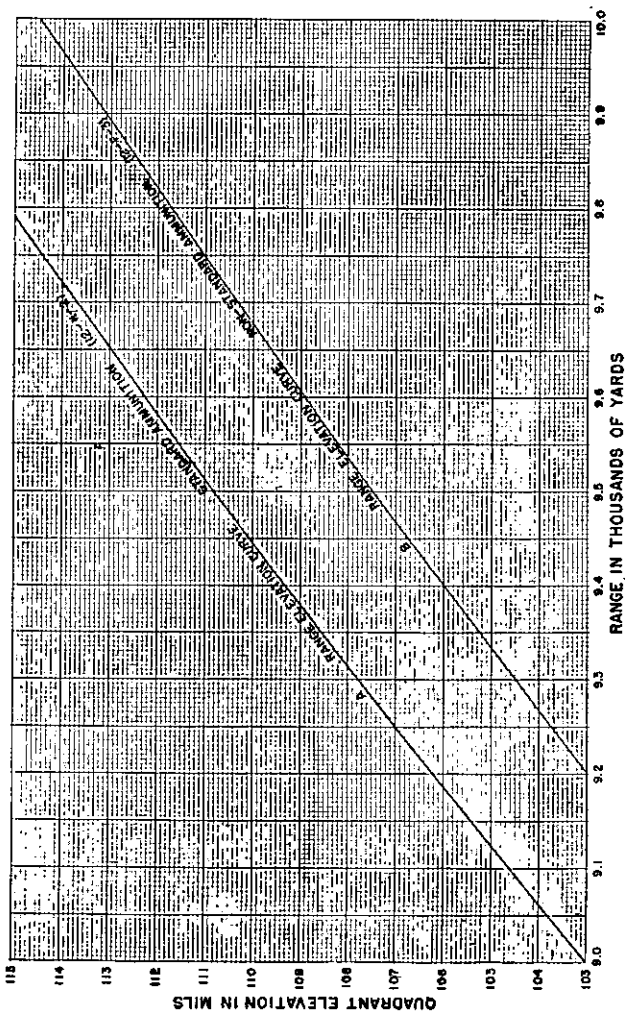

FIGURE 180.—Graphical method for obtaining range-range relation scale.

A represents the curve for the standard ammunition and was plotted from columns 1 and 4.

(3) In order to construct a range-range relation scale, figure 180 is used to determine where to place range disk settings using nonstandard ammunition with respect to the map range on the logarithmic scale. In constructing the scales, first construct a logarithmic scale of the ranges to be covered. Assume a range disk reading. It is necessary to determine the relative position of the logarithmic scale and the range disk setting scale. For example, if the range disk reading is assumed to be 9,200 yards, the elevation as determined from curve *A* is 106.2 mils. The range corresponding to this elevation on curve *B* is 9,415 yards. Opposite 9,415 on the logarithmic scale, place the 9,200 graduation on the range disk setting scale. This is continued until all the desired range graduations are located. The 20-yard graduations can be placed by the same method or by spacing uniformly between the 100-yard graduations. Figure 181 is a range-range relation scale plotted from figure 180.

NOTE.—Theoretically, the 20-yard graduations should not be spaced uniformly. However, the error caused by so locating these marks is so small that it may be neglected except below 2,000 yards. Below 2,000 yards, the 20-yard graduations should be determined individually as was done for the 100-yard graduations.

■ 13. PLOTTING THE WIND AND DRIFT CHART FOR M1 DEFLECTION BOARD.—*a.* Since the wind pointer on the M1 deflection board is at a 12-inch radius from the pintle of the board and operates in arcs of that radius, the data for one of the coordinates on the ballistic correction chart must be plotted along arcs of this radius. Also, the magnitude of the units used in plotting on this coordinate must be taken to the scale of the board.

b. Considering first the ordinate scale: This is a uniform scale marked either in yards of range or mils or degrees of elevation, depending on the type of graduations utilized in laying the gun in elevation. While the range or elevation scale is uniform for any one chart, it varies with different charts; the choice of the scale is a question of convenience and the accuracy desired. The range or elevation scale must be constructed parallel to the vertical center line of the chart

and must be displaced downward one-half inch (see fig. 182) because the elevation pointer on the M1 deflection board has been moved down by that amount to allow clearance for full movement of the wind pointer.

c. In the example in *f* below, the reference line for the wind and drift curves is taken on the center line of the chart. It may be placed elsewhere for convenience, but it must be parallel to the vertical center line of the chart.

d. When the wind and drift pointer is on the reference line, the board is adjusted so that there is no correction for wind and drift; but, when the pointer is moved away from the reference line by any angular distance, the azimuth read index (on the other side of the board) is displaced through the same angle. The displacement of the wind and drift pointer thus adds algebraically the wind and drift cor-

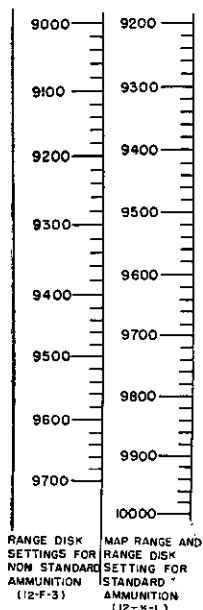

FIGURE 181.—Range-range relation scale (par. 12c).

rection to the uncorrected azimuth for case III firing. In case II firing the correction is added to the deflection through movement of the deflection scale. The problem is to draw the curves on the chart so that when the pointer is moved to any given curve, the azimuth read index or the deflection scale will be displaced by an amount indicated in the firing tables.

e. In plotting the variables measured along the arcs, the scale depends on whether mils or degrees are used. In the first case 200 mils of deflection correction equals 90° on the arcs, and in the second case 10° of deflection correction equals 90° on the arcs.

f. The plotting of the curve is explained best by an example. It is desired to plot the wind and drift correction chart for the 6-inch seacoast gun M1903A2 on barbette carriage M1, firing shot AP Mk. XXXIII with BD fuse M60 (Firing Tables 6-E-2). The data for wind and drift effects are taken from the firing tables and tabulated in the two tables following.

(1) Since the drift effects are given in steps of $.05^\circ$ and one particular value of drift may be listed for ranges differing by as much as 3,000 yards, it is necessary to take an average of the highest and lowest ranges given for any particular value of drift. For example, in the Firing Tables 6-E-2 mentioned, the drift for 4,500 yards and 7,500 yards is given as $.05^\circ$. Therefore, the average range would be 6,000 yards. Likewise for a drift of $.10^\circ$, the range taken is an average between 8,000 and 10,000 or 9,000 yards. It will be sufficiently accurate to take these averages to the nearest 100 yards. The average range for each value of drift is determined from the firing tables and tabulated. The quadrant elevations corresponding to these ranges are extracted from the tables and tabulated opposite the ranges and the drift effects. These values are shown in the following table.

COAST ARTILLERY FIELD MANUAL

TABLE I.—*Drift effects*

1	2	3
Range (yards)	Elevation (mils)	Drift effect (degrees)
0	0	0
6,000	48.0	.05
9,000	83.4	.10
11,000	113.8	.15
12,500	141.0	.20
14,000	172.6	.25
15,200	201.6	.30
17,200	257.4	.40
18,700	305.6	.50
20,200	358.8	.60
21,500	409.6	.70
22,500	452.6	.80
24,000	526.4	1.00
25,500	618.2	1.25
26,500	702.2	1.50
27,150	834.8	1.85

(2) From the firing tables, the cross wind effects for each 10 miles per hour of wind and for each 3,000 yards of range are tabulated. These effects are shown in columns 3 to 7 in the following table. These columns can be considered as giving effects either to the right or to the left. The elevations corresponding to the ranges in column 1 are given in column 2.

TABLE II.—*Wind effects*

1	2	3	4	5	6	7
Range (yards)	Eleva- tion (mils)	10	20	30	40	50
0	0	0	0	0	0	0
3,000	21.2	.03	.06	.09	.12	.15
6,000	48.0	.06	.12	.19	.25	.32
9,000	83.4	.10	.21	.31	.42	.52
12,000	131.4	.15	.30	.46	.61	.77
15,000	196.6	.21	.42	.62	.83	1.04
18,000	282.4	.26	.52	.78	1.04	1.31
21,000	389.4	.31	.61	.92	1.23	1.54
24,000	526.4	.35	.70	1.06	1.41	1.77
27,150	834.8	.45	.90	1.35	1.80	2.26

FIRE CONTROL AND POSITION FINDING

(3) Next, the scales to be used in constructing the chart must be selected. The angular scale is fixed by the construction of the board at 9° (on the chart) to 1° (on the ground). The ordinate scale, which in this case is to be a uniform elevation scale, can be plotted conveniently at 1 inch to 80 mils. The center line is used as a reference line for plotting the drift curve in this particular case. The following is the procedure to follow in constructing the ballistic correction chart:

(a) Draw the center line of the chart and select a starting point (origin) for the curves on the center line.

(b) Using the starting point as the origin, plot downward on the center line to a scale of 1 inch to 80 mils, the values of the elevations in column 2, table I, and label each point temporarily with the corresponding elevation.

(c) Through each of these points, draw an arc having a radius of 12 inches and a center on the center line above the point. These arcs will be referred to as the elevation arcs.

(d) Plot the drift curve in the following manner:

1. Along each elevation arc lay off an arc equal to nine times the drift effect (column 3, table I) for the corresponding elevation (column 2) measuring to the right from the reference line.

2. Through these points draw a smooth curve. This is the drift curve or 50 line (zero wind effect).

(4) The arcs on which the drift curve was laid out can now be erased. Using the same origin for the elevation scale, scale off the elevations listed in column 2 of table II and label as before. Through each of these points draw an arc having a radius of 12 inches and a center on the center line above the point. Plot the 40 line by laying off along each elevation arc to the right of the 50 line an arc equal to nine times the corresponding wind effect shown in column 3 of table II. Connect the points with a smooth curve which is marked 40. Plot the 30, 20, 10, and 0 lines in the same manner, using the effects in columns 4, 5, 6, and 7, respectively, and measuring each time to the right of the 50 line. The 60, 70, 80, 90, and 100 lines are plotted in the same manner, using columns 3, 4, 5, 6, and 7, respectively, except that the

COAST ARTILLERY FIELD MANUAL

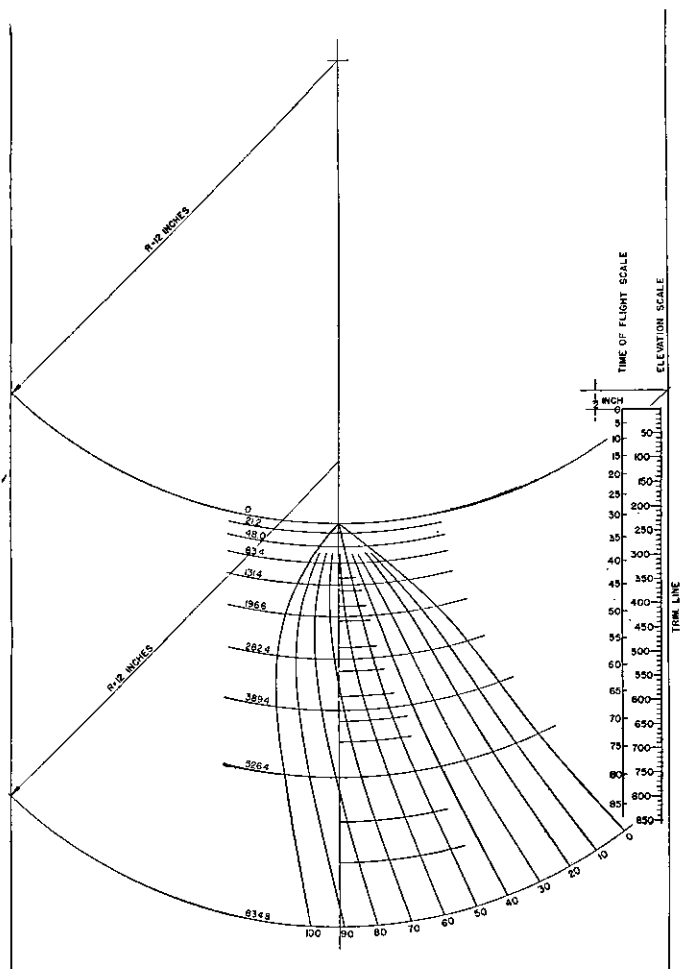

FIGURE 182.—Plotting of wind and drift chart, deflection board M1.

FIRE CONTROL AND POSITION FINDING

arcs are laid off to the left of the 50 line. When completed, number the lines consecutively from 0 to 100 in steps of 10 with the numbers increasing from right to the left.

(5) Theoretically, all curves will pass through the origin. To avoid congestion, however, some are cut off before they reach the origin. A trim line is drawn parallel to the center line and 8.375 inches on either side of it. The arc corresponding to zero elevation is extended to the trim lines. The uniform elevation scale is constructed 0.2 inch to the left of the right-hand trim line. The point of origin of the elevation scale is on a horizontal line 0.5 inch below the point of intersection of the trim line and the arc through the origin of the curves. This is necessary because the range or elevation pointer is displaced 0.5 inch to allow the wind pointer to pass it. The time of flight scale is plotted opposite the elevation scale as explained in paragraph 3b. On some charts (for long range guns) the wind effects are so great that if the center line of the chart is used as a reference line for plotting the 50 line, the lower portion of the series of curves will extend too far to the right. To avoid this difficulty, a reference line is drawn to the left of and parallel to the center line and the 50 line is plotted from this reference line. The other wind curves are plotted from the 50 line as before. It should be noted that in this case the origin of all curves will lie on the reference line, but the elevation arcs will still be centered on the center line.

g. In the example just given, the ordinate scale was a uniform elevation scale because the gun was laid in elevation by means of angular units. For guns set by means of range disks, a range scale could be plotted opposite the elevation scale in the same manner as was done with the time of flight scale, or the ordinate scale could have been made a uniform range scale and the curves plotted accordingly. The procedure is exactly the same in either case.

APPENDIX VII

INSTRUCTIONS FOR OBTAINING CHARTS AND SCALES FOR SEACOAST FIRE CONTROL INSTRUMENTS FROM THE COAST ARTILLERY BOARD, FORT MONROE, VIR- GINIA

■ 1. GENERAL.—Many of the present plotting room instruments for seacoast artillery fire control make use of charts or scales for the graphical determination of firing data. This appendix has been prepared to assist in obtaining charts and scales which may be requested directly from the Coast Artillery Board, Fort Monroe, Virginia. Care should be taken in submitting requests that sufficient information is supplied to identify properly the charts and scales desired. All concerned should avoid requesting excess quantities, duplicating requests, or submitting requests for which no need exists. Wherever possible, before submitting requests, a check should be made to ascertain that the charts and scales desired are not already on hand in the office of the local ordnance officer or artillery engineer.

■ 2. PREPARING REQUESTS.—*a.* Requests for charts and scales should be submitted in duplicate.

b. In all cases, the number required, the name of the chart or scale, and the name and model of the fire control instrument to which it applies should be given.

c. Particular care should be taken to submit sufficient data to enable prompt filling of the request.

■ 3. AVAILABLE CHARTS AND SCALES.—Table A lists charts and scales available at the Coast Artillery Board, Fort Monroe, Virginia. This list will assist officers in preparing requests and also should aid in avoiding errors in nomenclature when writing these requests. The numerals following each item listed should be used in entering table B to determine the information which should be submitted to identify properly the chart or scale desired. The examples cited illustrate the care with which requests for charts and scales should be worded to include all necessary information.

FIRE CONTROL AND POSITION FINDING

TABLE I.—Available charts, scales, and plans

1. Range correction board M1, M1A1, Pratt M1905, and improvised range correction board.

a. Range correction chart (1) (2) (3).

Example: 2 each—Range correction chart for range correction board M1 for 6-inch gun M1903A2 on 6-inch barbette carriage M1, firing 105-pound armor-piercing projectile Mk. XXXIII with base-detonating fuze M60, muzzle velocity 2,750 f/s and based on Firing Tables 6-E-2.

b. Plans and assembly drawing for local construction of an improvised range correction board (0).

2. Improvised range correction board (for 3-inch and 90-mm guns only).

a. Range correction chart (1) (2) (3).

b. Plans and assembly drawing for local construction of an improvised range correction board for 3-inch and 90-mm seacoast batteries (0).

3. Percentage corrector M1.

a. Logarithmic range scale (8).¹

b. Range elevation scale (1) (2) (3) (4) (6).²

Example: 2 each—Range elevation scale for percentage corrector M1 for 16-inch gun Mk. II (Navy) on barbette carriage 16-inch M1919M1, firing 2,240-pound armor-piercing projectile Mk. 12 with base-detonating fuze Mk. X, muzzle velocity 1,900 f/s and 2,650 f/s, based on Firing Tables 16-E-1, calculated for a height of site of 26 feet, and graduated in mills of elevation.

c. Range-range relation scale (1) (2) (3) (4) (6) (7).³

Example: 2 each—Range-range relation scale for percentage corrector M1 for 12-inch gun M1895M1 on barbette carriage M1917, firing 975-pound armor-piercing projectile Mk. XVI with base-detonating fuze Mk. X, muzzle velocity 2,275 f/s, based on Firing Tables 12-F-3, and for a height of site of 19 feet. Range disks are graduated in yards for same gun and carriage designated above, firing 1,070-pound armor-piercing projectile (shot) with base-detonating fuze Mk. X, muzzle velocity 2,250 f/s, based on Firing Tables 12-K-2 and graduated for a height of site of 19 feet.

d. Interpolator tape (4).

e. Adjustment and ballistic correction scales (0).

f. Plans and assembly drawing for local construction of an improvised percentage corrector (0).

4. Deflection board M1.

a. Wind and drift chart (1) (2) (3) (4) (5).

¹ A scale with ranges plotted logarithmically, used only with guns having a range disk graduated correctly in yards for the particular combination of gun, gun carriage, projectile, fuze, and powder charge being used and for the height of site above mean low water of the trunnions of the gun.

² A scale with ranges plotted logarithmically and with corresponding elevations in mills or degrees plotted correctly opposite the ranges for the particular combination of gun, gun carriage, projectile, fuze, and powder charge being used and for the height of site above mean low water of the trunnions of the gun.

³ A scale used to determine the correct range disk settings for firing a combination of projectile, fuze and powder charge other than the combination for which the range disk being used is graduated and, in some cases, for a height of site different from that for which the range disk is graduated.

COAST ARTILLERY FIELD MANUAL

TABLE I.—*Available charts, scales, and plans*—Continued

Example: 2 each—Wind and drift chart for deflection board M1 for 155-mm guns M1 and M1A1 on mobile carriage M1, firing high-explosive shell M101 with point-detonating fuze M51, normal and supercharge, based on Firing Tables 155-S-1, azimuth in degrees and hundredths, elevations in mills.

- b. Angular travel chart (0).
- 5. *Universal deflection board.*
- a. Wind and drift chart (1) (2) (3) (4) (5).
- b. Azimuth scales (5).
- c. Adjustment correction scales (5).
- d. Deflection scales for case II pointing (5).
- 6. *Set-forward rule.*
- Scales and plans for local construction (0).
- 7. *Set-forward scales* (9) (10) (11).
- 8. *Angular travel computer.*

Plans, and assembly drawing for local construction (0).

9. *Dispersion device.*

- a. Plans and assembly drawing for local construction (0).
- b. Dispersion tape (0).
- c. Adjustment correction scale (0).
- 10. *Improvised spotting board.*

Plans and assembly drawing for local construction (including all necessary charts and scales) (0).

■ 4. INFORMATION TO BE SUPPLIED.—Table II immediately following lists information to be supplied in order to obtain the charts and scales listed in table I. Entering table II with numerals listed after each item in table I, it can be determined what information must be supplied to identify properly the chart or scale desired.

TABLE II.—*Information which should be supplied in order to obtain charts, scales, and plans listed in table I*

General.—In all cases the quantity of each, the name of the chart, scale, or plan, and the name and model of the fire control instrument to which it applies should be specified.

(0) No information required; this item applies to any combination of gun, ammunition, firing tables, units of graduation, height of site.

(1) *Gun and carriage.**

- a. Caliber.
- b. Gun (mark or model designation).
- c. Gun carriage (mark or model designation.)

(2) *Ammunition.**

*These data can usually be obtained from the following sources:

- (a) Name plates on gun and carriage, or emplacement book.
- (b) Ammunition data card.
- (c) Appropriate firing tables, Field Manuals, and Technical Manuals.
- (d) Ordnance Department SNL F-69.
- (e) Local ordnance officer.
- (f) Local artillery engineer.

FIRE CONTROL AND POSITION FINDING

TABLE II.—*Information which should be supplied in order to obtain charts, scales, and plans listed in table I—Continued*

- (a) *Projectile.*
 1. Kind (shell, projectile, shrapnel, shot, practice, etc.).
 2. Type (armor-piercing, high-explosive, low-explosive, chemical).
 3. Mark or model designation.
 4. Weight.
- (b) *Fuze.*
 1. Kind (base-detonating or point-detonating).
 2. Mark or model designation.
- (c) *Charge.*—Reduced, normal, supercharge, or standard muzzle velocity. (In the case of mortar ammunition, state whether charges are aliquot part charges or base and increment charges.)
 - (3) *Firing tables which apply.*
 - (4) *Units of elevation used* (mils, degrees, or yards).
 - (5) *Units of azimuth used* (mils or degrees).
 - (6) *Height of site of the trunnions of the gun*, to the nearest foot for fixed seacoast batteries, to the nearest 100 feet for mobile batteries, measured from mean low water.
 - (7) *Basis of graduation of range disks used.*—When range disks are graduated in yards of range it is necessary to supply information on items (1) (2) (3) (4) and (6) as referred specifically to the range disk graduations since these graduations are based on a particular combination of gun, gun carriage, projectile, fuze, propelling charge, firing tables, and height of site. Where range disks are graduated in angular units of quadrant elevation (i. e. mil or degree units) the above additional information is not necessary since such graduations represent true quadrant elevations and are independent of any particular combination of armament, ammunition, and height of site.
 - (8) *Maximum range* (in yards).
 - (9) *Observing interval* (in seconds)
 - (10) *Dead time* (in seconds).
 - (11) *Measuring interval* (in seconds).

■ 5. URGENT REQUESTS.—It is recognized that occasions may arise when charts and scales are needed urgently where complete information is not available locally. In such cases, requests should state this fact, since on occasion it is possible that the Coast Artillery Board can supply the missing items of information.

■ 6. SPECIAL REQUESTS.—The most frequently used charts and scales are listed in table I. Actually, additional items are available which are not listed since requests for them rarely occur. The fact that some special item desired is not listed should not interfere with a prompt request to the Coast Artillery Board for this special item.

■ 7. CONCLUSION.—Careful attention to the instructions submitted in this appendix should expedite delivery of charts and scales to batteries.

APPENDIX VIII

BASIC THEORY OF SPOTTING BOARDS M2, M3, AND M7

■ 1. BASIC ASSUMPTIONS.—In figure 183, T represents the target. The spotting stations, S^1 and S^2 , and the directing point are not represented, but direction lines to those stations are shown. In designing the board the following assumptions were made: That as the line of sight from any station moves away from the target it moves parallel to itself; and that, in the vicinity of the target, points of equal range from each station are on straight lines perpendicular to the lines of sight. These assumptions are approximately true for the normal ranges to the target. Suppose the deviations ΔS^1 and ΔS^2 of a splash are reported from the spotting stations. According to the assumptions the lines of sight to the splash, BS and AS , are parallel to TS^1 and TS^2 , respectively, and BT and AT are perpendicular to TS^2 and TS^1 , respectively. S represents the position of the splash.

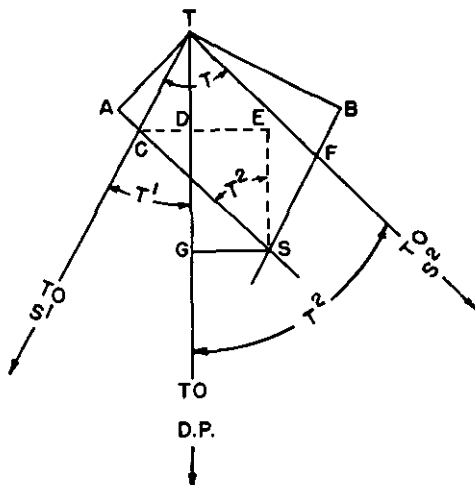

FIGURE 183.—Basic assumptions, spotting board.

■ 2. DERIVATION OF FORMULAS.—The derivation of the formulas is as follows: In figure 183, if R^1 and R^2 are the ranges to the target from the spotting stations S^1 and S^2 , respectively, we have—

Equation for range deviation TG:

$$\begin{aligned}
 AT &= R^2 \tan \Delta S^2 \\
 CT &= \frac{AT}{\cos(90^\circ - T)} = \frac{AT}{\sin T} = \frac{R^2 \tan \Delta S^2}{\sin T} \\
 TD &= CT \cos T^1 = \frac{R^2 \tan \Delta S^2 \cos T^1}{\sin T} \\
 BT &= R^1 \tan \Delta S^1 \\
 TF &= \frac{BT}{\cos(90^\circ - T)} = \frac{BT}{\sin T} = \frac{R^1 \tan \Delta S^1}{\sin T} \\
 CS &= TF = \frac{R^1 \tan \Delta S^1}{\sin T} \\
 DG &= ES = CS \cos T^2 = \frac{R^1 \tan \Delta S^1 \cos T^2}{\sin T} \\
 TG &= TD + DG \\
 TG &= \frac{R^2 \tan \Delta S^2 \cos T^1}{\sin T} + \frac{R^1 \tan \Delta S^1 \cos T^2}{\sin T} \quad (1)
 \end{aligned}$$

Equation for lateral deviation GS:

$$\begin{aligned}
 BT &= R^1 \tan \Delta S^1 \\
 TF &= \frac{BT}{\cos(90^\circ - T)} = \frac{R^1 \tan \Delta S^1}{\sin T} \\
 CS &= TF \\
 CE &= CS \sin T^2 = \frac{R^1 \tan \Delta S^1 \sin T^2}{\sin T} \\
 AT &= R^2 \tan \Delta S^2 \\
 CT &= \frac{AT}{\cos(90^\circ - T)} = \frac{R^2 \tan \Delta S^2}{\sin T} \\
 CD &= CT \sin T^1 = \frac{R^2 \tan \Delta S^2 \sin T^1}{\sin T} \\
 GS &= CE - (-CD) \\
 GS &= \frac{R^1 \tan \Delta S^1 \sin T^2}{\sin T} - \frac{R^2 \tan \Delta S^2 \sin T^1}{\sin T} \quad (2)
 \end{aligned}$$

Formulas (1) and (2) may be rewritten as follows:

$$TG = \frac{\pm R^1 \cos T^2}{\sin T} \tan \Delta S^1 \pm \frac{R^2 \cos T^1}{\sin T} \tan \Delta S^2 \quad (3)$$

$$GS = \frac{\pm R^1 \sin T^2}{\sin T} \tan \Delta S^1 \pm \frac{R^2 \sin T^1}{\sin T} \tan \Delta S^2 \quad (4)$$

In equations (3) and (4), TG and GS are in linear units corresponding to those used for R^1 and R^2 . The sign of each right-hand member of the equations depends on the direction in which ΔS^1 or ΔS^2 is measured and must be determined by inspection. In the situation illustrated in the figure, both ΔS^1 and ΔS^2 are negative in range effect, while in lateral effect ΔS^1 is positive and ΔS^2 negative.

Representing TG and GS by the terms ΔR and ΔL , respectively, and dividing by R , we get

$$\frac{\Delta R}{R} = \pm \frac{R^1}{R} \times \frac{\cos T^2}{\sin T} \tan \Delta S^1 \pm \frac{R^2}{R} \times \frac{\cos T^1}{\sin T} \tan \Delta S^2 \quad (3)$$

$$\frac{\Delta L}{R} = \pm \frac{R^1}{R} \times \frac{\sin T^2}{\sin T} \tan \Delta S^1 \pm \frac{R^2}{R} \times \frac{\sin T^1}{\sin T} \tan \Delta S^2 \quad (4)$$

But $\frac{\Delta R}{R}$ is proportional to the percentage deviation in range, and $\frac{\Delta L}{R}$ is very nearly equal to the lateral deviation in radians. The board may therefore be made to read range deviations in percentages and lateral deviations in angular units by giving the platen the proper graduations and setting the disks according to the ratios $\frac{R^1}{R}$ and $\frac{R^2}{R}$ instead of R^1 and R^2 . Provision is made for this on the spotting board.

APPENDIX IX

POINTING 155-MM GUNS WITH FIELD ARTILLERY TELESCOPES

■ 1. Some 155-mm gun seacoast batteries are provided with field artillery panoramic telescopes. These telescopes are graduated differently from coast artillery telescopes and, since their azimuth scales cannot be slipped, they present a problem when using standard coast artillery fire control and position finding equipment. The problem resolves itself into the application of coast artillery data to the field artillery panoramic telescope. This must be accomplished accurately and easily within the proper time interval.

■ 2. To understand the problem a short review of the requirements for coast artillery telescopes is essential. The requirements divide themselves into two categories: those for case II pointing and those for case III pointing. In case II pointing, deflections are involved. These deflections are determined in terms of reference numbers, the normal reference number being 200 for telescope scales graduated in mils and 10 for telescope scales graduated in degrees. In case III pointing, actual firing azimuths are involved; consequently, the telescope azimuth scale must be uniformly graduated in a complete circle. When using mils, these graduations must be from 0 through 6300 back to 0; when using degrees, the graduations must be from 0 through 350 back to 0. In addition, the graduations must increase progressively in such a direction that the gun will follow the firing azimuths while the telescope is kept in alinement with an aiming point. This requirement calls for an increase of the graduations in a clockwise direction. Since it is highly desirable that one telescope be adaptable to the requirements for both case II and case III pointing, it is necessary that the azimuth scale be adjustable to any reading when the line of sight and the axis of the bore are established in a given relationship.

■ 3. The coast artillery panoramic telescopes M2A1 and M8 are designed to meet the requirements for case II and case III pointing. The M2A1 telescope uses the mil system of graduations and the M8 telescope uses the degree system of graduations. Both have azimuth scales which can be slipped and which are graduated in a clockwise direction. The M8 telescope has, in addition, a separate deflection scale which permits an initial orientation for both case II and case III pointing and does not require reorientation, as does the M2A1 telescope, when switching from case II to case III pointing, or vice versa.

■ 4. Field artillery panoramic telescopes, one model of which is shown in figure 184, are provided with mil graduations and do not meet the coast artillery requirements in two respects. First, the azimuth scale is not adjustable; hence, for case II pointing, the scale cannot be made to read 200 when the line of sight is parallel to the axis of the bore (the field artillery azimuth scale is constructed to read 0 when the line of sight is parallel to the axis of the bore). For case III pointing, the scale cannot be made to read the azimuth of the axis of the bore when the line of sight is alined on an aiming point. Second, the azimuth scale of the field artillery panoramic telescope is graduated counterclockwise, 0 to 3100, 0 to 3100, instead of clockwise, 0 through 6300 mils, back to 0. (See fig. 185.) The 3200 graduation does not appear as it is represented by 0. Therefore, when the line of sight is to the front, parallel to the axis of the bore, a 0 appears at the azimuth scale index; also, when the line of sight is reversed, or to the rear, parallel to the axis of the bore, a 0 appears at the azimuth scale index. This necessitates reversing the coast artilleryman's rule, "Right, raise—left, lower," to Left, add; right, subtract," which is the rule used in field artillery gunnery;

In order to adapt the field artillery panoramic telescope to the coast artillery problem, the following suggestions are made. It is assumed that the plotting room is equipped with the deflection board M1 and a range percentage corrector.

a. In case II pointing, the difference between the telescopes can be taken care of by changing the graduation numbers on the deflection scale of the deflection board. Remembering

that on the field artillery telescope the reading is 0 when the line of sight is parallel to the axis of the bore, it will be readily understood that the output from the deflection board must read 0 when the deflection is normal. This conversion is most easily made by changing the graduation numbers on the deflection scale of the deflection board.

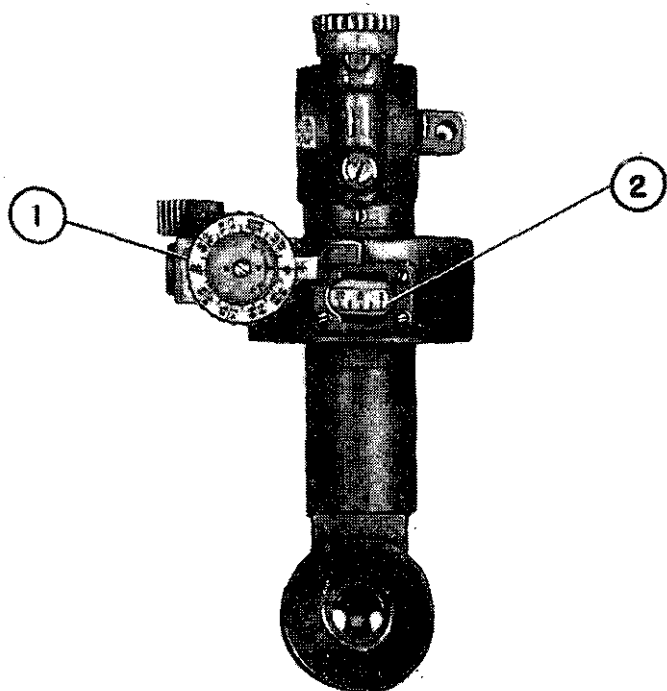

FIGURE 184.—Field artillery panoramic telescope M6.

(1) If the base-end observations are in degrees, the input to and the output from the plotting board should be in degrees for simplicity of operation. The deflection board, therefore, should be set up to operate in degrees. Assume that the deflection scale, with 10 as normal, is mounted on the deflection board. In order to obtain deflection readings which

can be set on the field artillery panoramic telescope, the deflection scale graduations must be changed. To do this, obtain a good grade of smooth paper (drawing paper preferred) and cut it to the size and shape of a deflection scale. Lay the cut paper over the deflection scale, slipping the paper slightly toward the center of the board, thus exposing the graduation markings of the metal scale. In this position

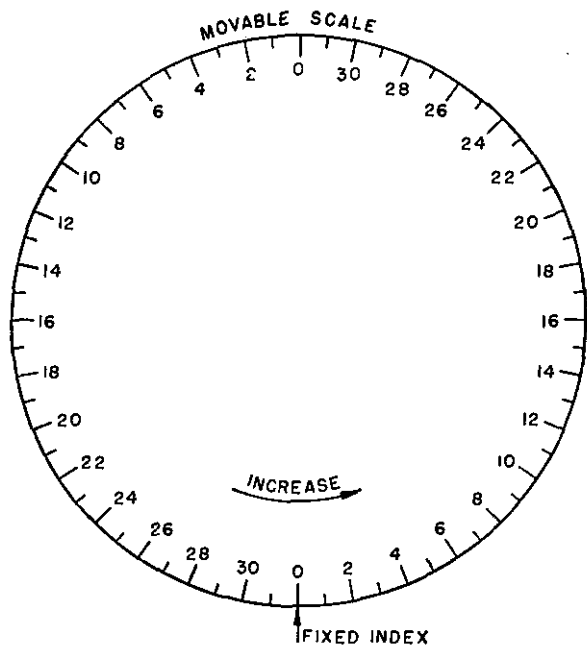

FIGURE 185.—Method of graduating field artillery panoramic telescope azimuth scale in mils.

clamp the paper to the scale with some device such as spring paper clamps. In line with the 10 graduation of the deflection scale, make a marking on the paper and label it 0. Next mark the paper in line with the 12.25 and 7.75 graduations on the output scale, and label these markings 3160 and 40, respectively. Similarly, mark the paper in line with the

FIRE CONTROL AND POSITION FINDING

14.50 and 5.50 graduations on the output scale, and label these markings 3120 and 80, respectively. Then remove the paper and accurately subdivide the spacings between 0 and 40, 40 and 80, 0 and 3160, and 3160 and 3120 into 40 equal parts. Make each fifth marking slightly longer than the rest and each tenth marking longer than the fifth markings. Label the tenth markings as follows:

Starting at 0 and progressing to the right—3190, 3180,
3170, 3160*, 3150, 3140, 3130, 3120*.

Starting at 0 and progressing to the left—10, 20, 30,
40*, 50, 60, 70, 80*.

Each graduation equals a mil, and each tenth graduation is labeled. This paper scale is now pasted over the output scale of the deflection board, the 0 graduation of the paper scale being carefully matched over the 10 graduation on the output scale of the board. (See fig. 186.)

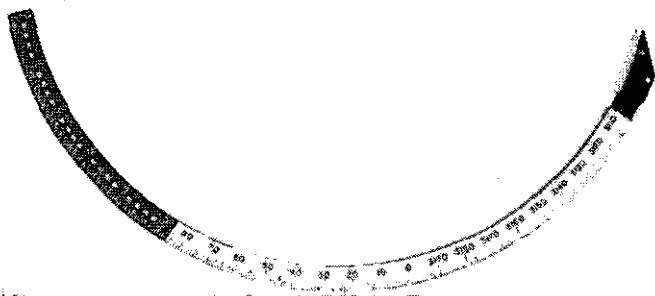

FIGURE 186.—Conversion scale completely graduated and labeled.

NOTE.—*Left deflections* (those made when the bore of the gun is pointing to the left of the target) are marked with numbers in ascending numerical order and *right deflections* are marked with numbers in descending order. The deflection readings now taken from the deflection board can be sent directly to the gun pointer for setting on the field artillery panoramic telescope.

(2) On the other hand, if base-end observations are in mils, the plotting board and deflection board should be set up to operate in mils. In this case a blank piece of smooth paper should be cut and placed over the labeling on the

*Already labeled from previous operations.

deflection scale (200 normal). The graduations should remain exposed. Then change the labeling of the graduations as follows (see fig. 187) :

<i>Original labeling</i>	<i>New labeling</i>
200	0
210	3190
220	3180
230	3170, etc.
190	10
180	20
170	30, etc.

NOTE.—Deflections are graduated in the same manner as described above. The readings from the deflection board can now be applied directly to the field artillery panoramic telescope.

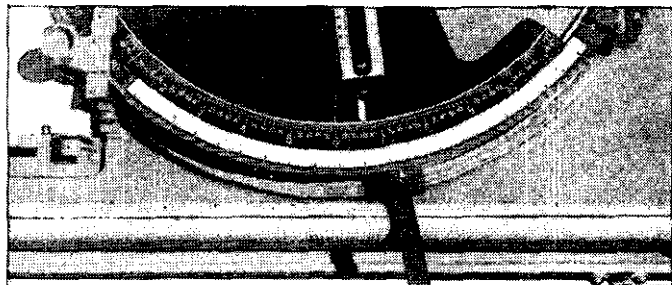

FIGURE 187.—Deflection board M1 converted to operate with field artillery panoramic telescope.

b. When using case III pointing, a different problem is presented by the fact that the azimuth scale on the field artillery panoramic telescope cannot be slipped; that is, the azimuth set on the telescope cannot be changed without moving the line of sight. Therefore, some alternate means must be provided to change the firing azimuths into telescope settings. To accomplish this, a conversion tape similar to a percentage corrector tape is used. One scale on this tape has azimuth readings covering the field of fire. The other scale has telescope readings. The 0 reading of the telescope scale on the tape must be opposite the azimuth of the aiming point on the azimuth scale. The relation between the two scales then depends upon the azimuth of the aiming point to be

FIRE CONTROL AND POSITION FINDING

used. The telescope scale readings must increase as the azimuth scale readings decrease. If the corrected azimuth is computed in mils in the plotting room, both scales are plotted to the same scale factor in opposite directions. If the corrected azimuth is computed in degrees, the scales should be plotted to a degree-mil relationship, again in opposite directions. An operator, by means of this device, converts corrected azimuths to telescope readings.

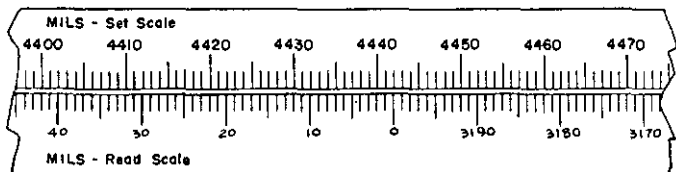

FIGURE 188.—Mil-mil scale.

■ 5. The two types of tape are illustrated in figures 188 and 189.

a. To make the tape shown in figure 188, two horizontal lines are drawn on the tape. Above the upper line, azimuths are plotted in mils to a convenient scale, say 10 mils to 1 inch. The scale should be long enough to cover the entire field of fire and should be labeled "set scale." Beneath the lower line, the 0 is plotted opposite the "set" reading which is the azimuth from the directing point to the aiming point. This is labeled the "read scale." In figure 188 it has been assumed that the azimuth of the aiming point is 4,442 mils. The mil graduations on the "read scale" are plotted to the scale of 10 mils to 1 inch, with 0 as a starting point, following the rule that graduations on the "read scale" decrease as azimuths on the "set scale" increase. The graduations are labeled so there can be no reading above 3,199 mils on the "read scale." However, there will be two 0 readings: one opposite the aiming point azimuth reading on the "set scale" and one opposite the reading on the "set scale" which differs from the aiming point azimuth by 3,200 mils.

b. To prepare a degree-mil conversion tape (see fig. 189), degrees are plotted on the upper line to a scale of 1° equals 1.778 inches. This is derived from applying the mil-degree

relation to the basic scale of 10 mils equal 1 inch. The 0 of the "read scale" is located opposite the "set scale" reading which is the azimuth of the aiming point (in this case assumed to be 250.12°). "Read scale" graduations are then plotted on either side of the 0 to a scale of 10 mils to the inch. In labeling these graduations, follow the rule that the graduations on the "read scale" decrease as the azimuths on the "set scale" increase.

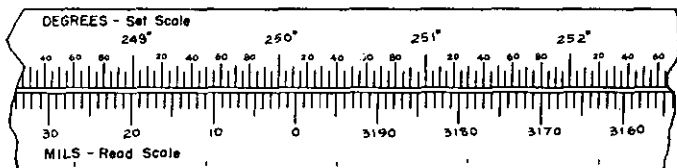

FIGURE 189.—Degree-mil scale.

c. In situations where the field of fire is limited, and the aiming point is in a direction to the rear of the guns, considerable footage of unusable tape can be saved by plotting the 0 of the "read scale" opposite the reading on the "set scale" which is 3200 mils greater or less than the azimuth of the sight-aiming point line; greater if the azimuth is less than 3200 mils, and less if the azimuth is greater than 3200 mils. The gun pointer in these cases must be instructed to start with the azimuth scale set to 0 and the telescope pointing to the rear.

■ 6. Conversion scales can be obtained from the Coast Artillery Board, Fort Monroe, Virginia. Requests for these conversion scales should state the number required and whether azimuths are determined in degrees or mils since this will determine whether degree-mil or mil-mil scales will be supplied. The conversion scales supplied are blank scales suitably graduated but not labeled (except in the case of the mil-mil scale on which the azimuth or "set scale" is already graduated). These are illustrated in figures 190 and 191. On receipt of these scales it is necessary for the individual battery to label the appropriate graduations with the proper numerical values and to extend every appropriate 20th gradu-

ation on the degree scale and every 10th graduation on the mil scale (see figs. 190 and 191). This is done with an ordinary writing pen and pen holder using a concentrated solution of soda bicarbonate as the labeling solution. White, yellow, or silver crayon or pencil may also be used.

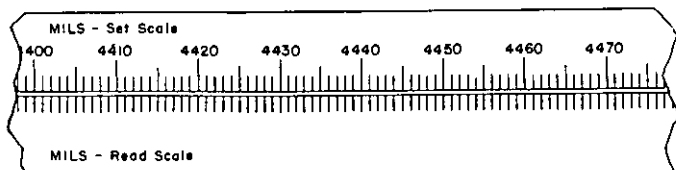

FIGURE 190.—Mil-mil scale supplied by Coast Artillery Board.

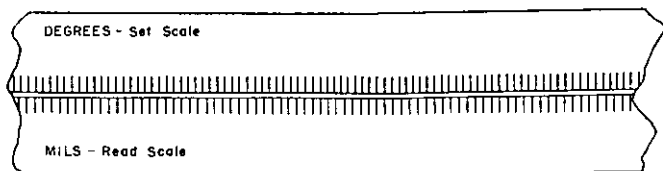

FIGURE 191.—Degree-mil scale supplied by Coast Artillery Board.

■ 7. A new conversion scale with a different relationship between the "set scale" (azimuths) and "read scale" (telescope settings) must be constructed for each separate aiming point. The relationship between the "set scale" and "read scale" is determined by the azimuth of the aiming point from the directing point. In all cases 0 on the set scale is located opposite the azimuth of the aiming point. If the azimuth of the aiming point is unknown, the reading of the panoramic telescope with the bore of the gun sighted at some known datum point should be located on the "read scale" opposite the azimuth from the directing point to the datum point.

a. When constructing a degree-mil conversion scale, 0 of the "read scale" should be located opposite the exact azimuth of the aiming point or, as described above, the telescope setting should be located opposite the exact azimuth of the gun tube as determined by boresighting. Care should be taken to choose a mil graduation on the "read scale" which coincides with the exact azimuth on the "set scale." For example

(see fig. 189), assuming an aiming point at an azimuth of 250.12° , 0 on the "read scale" would be located at a mil graduation on the "read scale" which is situated approximately two-fifths of the distance between any two $.05^\circ$ graduations on the "set scale." The left $.05^\circ$ graduation will then correspond to 250.10° and the $.05^\circ$ graduation to the right will correspond to 250.15° . In this way an exact initial relationship is established between the "set scale" and the "read scale."

b. When constructing a mil-mil conversion scale, 0 of the "read scale" should likewise be located opposite the exact azimuth of the aiming point. For example (see fig. 188), assuming an aiming point at an azimuth of 4442 mils, 0 on the "read scale" would be located opposite 4442 mils on the "set scale."

■ 8. Once the initial matching of the conversion scales has been established, labeling and extending of graduations should be carried out as described previously and as illustrated in figures 188 and 189. Much time can be saved by constructing the conversion scale of sufficient length to include only azimuths and telescope settings actually in the field of fire for which the aiming point is used.

■ 9. When corrected azimuths are determined with the deflection board M1 the conversion scales should be mounted in a small box with two rollers and a reading index. Plans for construction of this conversion scale box can be obtained from the Coast Artillery Board, Fort Monroe, Virginia. This box is used only when determining correct telescope settings for case III firing.

■ 10. Changing from one aiming point to another in an emergency can be accomplished by using a second box containing the appropriate tape or having the azimuth output operator in the plotting room change from one tape to another. Tapes for all aiming points should be constructed before the battery goes into position. The use of this conversion tape will necessitate the assignment of a special operator. The output operator on the deflection board does not have time to take care of this tape in addition to his other duties. Therefore, a man should be trained in the operation

of the conversion tape and assigned to it, so there will be no confusion when the battery uses case III pointing in either drill or actual firing.

■ 11. When corrected azimuths are determined with the universal deflection board, the conversion scales should be substituted for the standard azimuth and deflection scales normally mounted on the two rollers at either end of the board. In this manner, azimuths obtained from the plotting board are set on the "set scale" and the readings to be set on the panoramic telescope are obtained from the lower "read scale." This procedure effects the necessary conversion from azimuth to telescope setting. When firing with case II, the deflection scales found at the end of each tape should be used in the normal manner discussed in chapter 13. It is to be noted that, when using the angular travel computer to determine deflection settings for angular travel, the deflection scale used on the angular travel computer should conform to the universal deflection board deflection scale which is itself determined by the panoramic telescope being used.

APPENDIX X

DERIVATION OF PREDICTION FOR GUN DATA COMPUTER M1

■ 1. SYMBOLS.—The following symbols are used to indicate the elements of data (see figs. 192 and 194) :

<i>A, B, C</i>	Points locating the positions of observation stations.
<i>G₁</i>	Point locating the position of the directing point or gun No. 1.
<i>G₂</i>	Point locating the position of gun No. 2.
<i>A Az</i>	Azimuth of line <i>A T₀</i> .
<i>B Az</i>	Azimuth of line <i>B T₀</i> .
<i>C Az</i>	Azimuth of line <i>C T₀</i> .
<i>Az G₁</i>	Firing azimuth, gun No. 1.
<i>Az G₂</i>	Firing azimuth, gun No. 2.
<i>A₀</i>	Azimuth of the line from <i>G₁</i> to <i>T₀</i> (the present azimuth).
<i>A₀</i>	Angular rate of change of present azimuth (radians per second).
<i>A_p</i>	Azimuth of the line from <i>G₁</i> to <i>T_p</i> (the predicted azimuth).
ΔA	(<i>A_p</i> - <i>A₀</i>) (uncorrected deflection).
<i>AT</i>	Distance <i>A</i> to <i>T₀</i> .
<i>BT</i>	Distance <i>B</i> to <i>T₀</i> .
<i>CT</i>	Distance <i>C</i> to <i>T₀</i> .
<i>R₀</i>	Distance <i>G₁</i> to <i>T₀</i> (present range).
<i>R₀</i>	Rate of change of <i>R₀</i> (yards per second).
<i>R_p</i>	Distance <i>G₁</i> to <i>T_p</i> (predicted range).
<i>R'_p</i>	Corrected predicted range.
<i>R₀A₀</i>	Linear rate of lateral displacement (yards per second).
<i>t</i>	Time of flight to <i>T_p</i> .
<i>T_p</i>	Predicted position of target.
<i>T₀</i>	Present position of target.

■ 2. PREDICTION FORMULA FOR *R_p*.—*a.* In the gun data computer M1, continuous tracking produces a known rate of change of the target position.

FIRE CONTROL AND POSITION FINDING

b. At the instant the target is at T_0 , establish a line between G_1 and T_0 , which will be designated as the X axis in a system of rectangular coordinates (see fig. 192). Because of previous observation, the rate of change of present range is known, which, at this instant, is along the X axis.

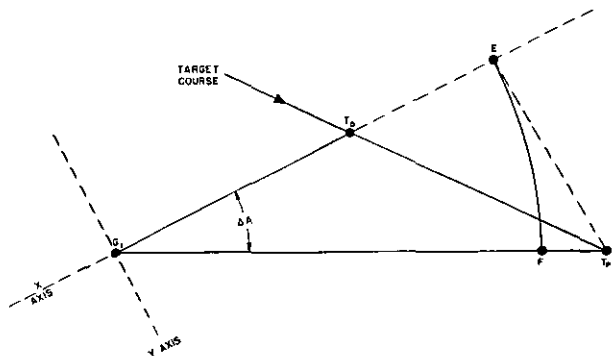

FIGURE 192.—Range prediction, outgoing target.

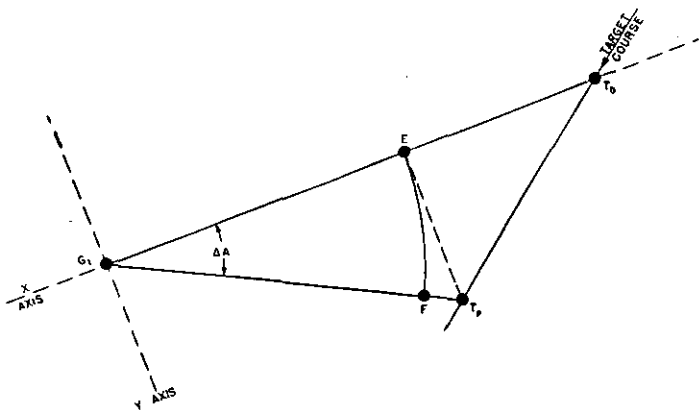

FIGURE 193.—Range prediction, incoming target.

c. From T_p , the predicted position of the target (fig. 192), drop a perpendicular to G_1T_0 , which intersects at E . Now ET_0 represents the product $R_0 \dot{t}$. With G_1 as center, swing an arc with radius G_1E .

NOTE.— ET_0 is the projection of the target's motion on the line G_1T_0 and is, therefore, the range component along the line G_1T_0 .

Then

$$R_p = R_0 + T_0E + FT_p \quad (1)$$

$$ET_0 = R_0 \dot{t} \quad (\text{sec above}) \quad (2)$$

$$FT_p = R_p - G_1F = R_p - G_1E \quad (3)$$

$$G_1E = R_p \cos \Delta A \quad (4)$$

Substituting the value from (4) in (3)

$$FT_p = R_p - R_p \cos \Delta A = R_p (1 - \cos \Delta A) \quad (5)$$

From the trigonometric series

$$\cos \Delta A = 1 - \frac{\Delta A^2}{2!} + \frac{\Delta A^4}{4!} - \frac{\Delta A^6}{6!} + \dots \quad (6)$$

NOTE.— ΔA is in radians.

The terms beyond $\frac{\Delta A^2}{2!}$ may be dropped without appreciable error because of the small angles involved.

Therefore

$$\cos \Delta A = 1 - \frac{\Delta A^2}{2} \quad (7)$$

and

$$1 - \cos \Delta A = 1 - \left(1 - \frac{\Delta A^2}{2}\right) = \frac{\Delta A^2}{2} \quad (8)$$

Substituting from (8) in (5)

$$FT_p = R_p \frac{\Delta A^2}{2} \quad (9)$$

Substituting these values from (2) and (9) in (1)

$$R_p = R_0 + R_0 \dot{t} + R_p \frac{\Delta A^2}{2} \quad (10)$$

By substitution of the entire right-hand side of equation (10) for the value of R_p in the last term of (10), we get

$$\begin{aligned} R_p &= R_o + R^{o_o}t + \left(R_o + R^{o_o}t + R_p \frac{\Delta A^2}{2} \right) \frac{\Delta A^2}{2} \\ &= R_o + R^{o_o}t + R_o \frac{\Delta A^2}{2} + R^{o_o}t \frac{\Delta A^2}{2} + R_p \frac{\Delta A^4}{4} \end{aligned} \quad (11)$$

Since $R_p \frac{\Delta A^4}{4}$ is very small, the term may be dropped

Then

$$R_p = R_o + R^{o_o}t + R_o \frac{\Delta A^2}{2} + R^{o_o}t \frac{\Delta A^2}{2} \quad (12)$$

Then, by factoring

$$R_p = (R_o + R^{o_o}t) \left(1 + \frac{\Delta A^2}{2} \right) \quad (13)$$

Equation (13) gives the predicted range for all courses of the target. If the range is decreasing, R^{o_o} will be negative. (See fig. 193.)

■ 3. PREDICTION FORMULA FOR A_p .—In figure 194, establish an X and Y axis as was done in the case of range prediction.

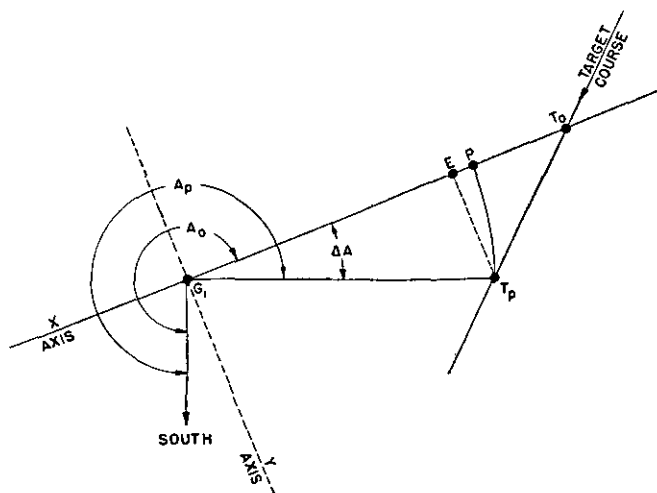

FIGURE 194.—Azimuth prediction.

$$ET_p = R_o A_o t \quad (14)$$

$$R_p \Delta A = PT_p \quad (15)$$

$$ET_p = PT_p \text{ (for small angles, the sine equals the arc)}$$

$$R_p \Delta A = ET_p \text{ (by substitution)} \quad (16)$$

$$R_p \Delta A = R_o A_o t \text{ (from (14))} \quad (17)$$

$$\Delta A = \frac{R_o A_o t}{R_p} \quad (18)$$

$$A_p = A_o + \Delta A \text{ (by definition)} \quad (19)$$

$$A_p = A_o + \frac{R_o A_o t}{R_p} \quad (20)$$

a. This assumes an increase in azimuth; that is, A_o is positive. If travel is counterclockwise, A_o will be minus.

b. Both predicted range and predicted azimuth are corrected for nonstandard ballistic conditions in the final solution.

APPENDIX XI

LIST OF REFERENCES

- Auxiliary fire-control instruments (field glasses, eyeglasses, telescopes, and watches) ----- TM 9-575.
- Azimuth instruments:
- Azimuth instruments M1910 and M1910A1_ TM 9-1675.
- Azimuth instruments M1918 and M1918A2_ TM 9-1680.
- Care and maintenance of the 155-mm gun GPF:
- Part VII—Checking the cross level of the quadrant sight ----- TF 4-1009.
- VIII—Orienting the panoramic telescope M2A1 for case II pointing ----- TF 4-1010.
- IX—Orienting the panoramic telescope M2A1 for case III pointing ----- TF 4-1011.
- X—Checking and adjusting the telescope mount M6A1 ----- TF 4-1012.
- XI—Orienting the panoramic telescope M8 for case II pointing_ TF 4-1013.
- XII—Orienting the panoramic telescope M8 for case III pointing ----- TF 4-1014.
- Coast artillery gunner's instruction:
- Fixed seacoast artillery, expert gunners_ TM 4-310.
- Fixed seacoast artillery, first and second class gunners ----- TM 4-305.
- Mobile seacoast artillery, expert gunners_ TM 4-320.
- Mobile seacoast artillery, first and second class gunners ----- TM 4-315.
- Depression position finders:
- Depression position finder M1_----- TM 9-1695.
- Depression position finder M1907_----- TM 9-1685.
- Elevation quadrant M1_----- TM 9-1557.

COAST ARTILLERY FIELD MANUAL

Fire control and position finding for seacoast artillery:

Part I—Position finding systems.....	TF 4-917.
II—Nonstandard ballistic conditions.....	TF 4-918.
III—Computing and setting firing data.....	TF 4-919.
IV—Pointing methods and reference numbers.....	TF 4-920.
V—M1 plotting board and M1 range correction devices.....	TF 4-921.
VI—M1 deflection board.....	TF 4-922.
VII—Dispersion, errors, and spotting systems.....	TF 4-923.
VIII—M3 spotting board.....	TF 4-924.
IX—Fire adjustment, the magnitude correction method and lateral adjustment.....	TF 4-925.
X—Fire adjustment, the bracketing method.....	TF 4-926.

Fire control and position finding for seacoast artillery—Continued.

Part I—Basic principles.....	FS 4-27.
II—Azimuth instruments.....	FS 4-63.
III—Horizontal base system.....	FS 4-64.
IV—Theory of the vertical base system.....	FS 4-65.
V—Orientation, range adjustment, and operation of depression position finder M1907.....	FS 4-66.
VI—Orientation, range adjustment, and operation of depression position finder M1.....	FS 4-69.
VII—How the coincidence range finder works.....	FS 4-70.
VIII—The 9-foot coincidence range finder.....	FS 4-71.
IX—The 15-foot coincidence range finder, adjustment.....	FS 4-72.
X—The 15-foot coincidence range finder, operation.....	FS 4-73.

FIRE CONTROL AND POSITION FINDING

Fire control and position finding, seacoast artillery—Continued.

XI—110° plotting board M1915, description and operation.....	FS 4-74.
XII—Clope and M1 plotting boards, description.....	FS 4-75.
XIII—Clope and M1 plotting boards orientation, section I.....	FS 4-76.
XIV—Clope and M1 plotting boards, orientation, section II.....	FS 4-77.
XV—Clope and M1 plotting boards, operation.....	FS 4-78.
XVI—Theory of prediction.....	FS 4-79.
XVII—Prediction devices.....	FS 4-80.
XVIII—Nonstandard ballistic conditions.....	FS 4-81.
XIX—Meteorological message.....	FS 4-82.
XX—Firing Tables.....	FS 4-83.
XXIII—Percentage corrector M1.....	FS 4-86.
XXIV—Wind component indicator.....	FS 4-87.
Formations, inspections, service, and care of matériel.....	FM 4-20.
Gunnery.....	FM 4-10.
Height finder M1.....	TM 9-2623.
	TM 9-1623.
Adjustment prior to operations.....	TF 4-586.
Care and maintenance.....	TF 4-589.
Drill.....	TF 4-587.
March order.....	TF 4-588.
Use.....	TF 4-585.
Identification of merchant ships.....	FS 4-28.
Meteorology for coast artillery.....	TM 4-240.
Orientation.....	TM 4-225.
Panoramic telescopes:	
Panoramic telescope M8.....	TM 9-1582.
Panoramic telescopes M1917, M1, M2A1, M3A1, M4, M5A2, M5A3, M5A4, M5A5, M5A6, M6.....	TM 9-1553.
	TM 9-1583.
Plotting boards:	
Plotting boards for seacoast artillery.....	TM 9-1570.
Plotting boards M3 and M4.....	TM 9-2681.

COAST ARTILLERY FIELD MANUAL

Quadrant sights M1917, M1917A1, M1918, M1918A1	TM 9-1555.
Spotting board M3	TM 9-2682.
Stereoscopic range and height finding	TM 4-250.
Surveying tables	TM 5-236.
Target practice, coast artillery	TM 4-235.
Telescope mounts:	
Telescope mount M18A1	TM 9-1553.
Telescope mount M6A1	TM 9-1554.
12-inch gun battery, barbette carriage:	
Part III—Checks for base ring and range disk	TF 4-632.
VIII—Checks for pointing and direc- tion	TF 4-948.

INDEX

	Paragraph	Page
Adjustment of fire. (See Fire adjustment.)		
Aiming point-----	127	220
Aiming rule:		
Adjustment-----	132	238
Description-----	132	238
Operation-----	132	238
Use in case III adjustment-----	127	220
Alternate base lines-----	18	14
Alternate fire control methods:		
Central control-----	173, 174	320
Gun commander's control-----	175, 176	324, 325
Modified one-station method-----	172	315
One-station fire control system-----	166-171	303
Principles-----	165	300
Temporary and stand-by control, 90-mm-----	177, 178	326
Alternate stations-----	18	14
Alternate systems-----	19	14
Angular system-----	11	8
Angular travel:		
Lateral corrections, 3-inch guns-----	161	296
Reference numbers-----	60	92
Angular travel computer:		
Description-----	101	169
Operation-----	102	171
Angular units-----	12	8
Approximate data. (See Data.)		
Areas. (See Harbor defense water areas.)		
Assignment of targets. (See Target.)		
Atmospheric refraction-----	48	50
Auxiliary matériel:		
Gun data computer M1-----	206	348
Gun data computer M8-----	220	362
Axis of bore. (See Azimuth of axis of bore.)		
Azimuth circles:		
Adjustment-----	133	242
Description-----	133	242
Operation-----	133	242
Azimuth, corrections-----	24	19
Azimuth difference:		
Application-----	31	25
Chart-----	30	22
Formulas-----	28, 29	21, 22
Azimuth instrument:		
M1910A1:		
Adjustment and orientation-----	46	41
Description-----	46	41
Operation-----	46	41
M1918-----	47	48
M2-----	205, 206	348
Azimuth instruments-----	46, 47, 205, 206	41, 48, 348
Azimuth measurement-----	11, 12	8

INDEX

	Paragraph	Page
Azimuth of axis of bore.....	134	245
Azimuth prediction, gun data computer M1.....	App. X	478
Base lines. (See Alternate base lines.)		
Battery personnel.....	235-237	380
Boresights:		
Care and preservation.....	130	228
Description.....	130	228
Operation.....	130, 134	228, 245
Bracketing adjustment chart.....	155-157	287
Construction.....	156	288
Operation.....	157	291
Cases of pointing. (See Pointing.)		
Central control.....	173, 174	320
Charts:		
Azimuth difference.....	30	22
Bracketing adjustment.....	155-157	287
Construction:		
Using rectangular coordinates.....	App. VI	434
Using polar coordinates.....	App. VI	434
Wind and drift, deflection board M1.....	App. VI	434
Definition.....	App. VI	434
Elevation difference.....	36	30
Instructions for obtaining.....	App. VII	460
Range difference.....	33	21
Circle. (See Azimuth circle.)		
Clinometer.....	116	204
Clinometer rest.....	116	204
Coincidence range finders.....	54-56	71
15-foot.....	55	71
9-foot.....	56	82
Commands, contents.....	8	5
Communications, landward firing.....	196	340
Computer. (See Angular travel computer.)		
Coordinates:		
Polar.....	App. VI	434
Rectangular.....	App. VI	434
Corrected firing data, calculation.....	250	391
Corrections:		
Azimuth.....	24	19
Deflection.....	24	19
Range.....	23	17
Corrector M1, percentage. (See Percentage corrector M1.)		
Data:		
Approximate.....	249	390
Corrected.....	250	391
Furnishing.....	43	38
Preliminary steps.....	248	389
Preparation for calculation.....	247	388
Uncorrected.....	20, 21	15, 16
Data transmission systems, electrical:		
Gun data computer M1.....	205	348
Gun data computer M8.....	219	362
Indicators.....	137	253

INDEX

	Paragraph	Page
Definitions	App. I	399
Deflection board M1:		
Azimuth mechanism, corrective measures.....	109	199
Conversion to operation in mils.....	108	197
Description.....	104	171
Displacement corrector, theory.....	App. V	422
Lateral adjustment scale.....	106	191
Mounting charts.....	105	188
Operation.....	107	192
Wind and drift chart.....	App. VI	434
Deflection boards, subcaliber practice.....	259	394
Deflection boards. (See Universal deflection board.)		
Deflection, corrections.....	24	19
Depression position finder:		
M1907:		
Adjustment and orientation.....	51	60
Description.....	51	60
Operation.....	51	60
M1:		
Adjustment for range.....	52	65
Description.....	52	65
Operation.....	52	65
Orientation (azimuth).....	52	65
M2.....	205, 206	348
Depression position finder. (See Swasey position finder.)		
Depression position finders.....	48-52, 205, 206	50, 348
Orientation above waterline.....	App. III	412
Destruction of equipment.....	267	397
Details:		
Observing.....	232	373
Plotting room.....	234	375
Range section.....	232-234	373
Spotting.....	233	374
Directing point:		
Two-gun batteries.....	27	21
Four-gun batteries.....	27	21
Direction. (See Pointing.)		
Displacement corrector, deflection board M1.....	App. V	422
Distances to horizon. (See Horizon.)		
Drill.....	244	384
Electrical data transmission systems. (See Data transmission systems.)		
Elevation, determination for 3-inch guns.....	160	295
Elevation difference:		
Application.....	37	33
Chart.....	36	30
Formula.....	35	30
Elevation quadrant M1917:		
Adjustment.....	119	211
Description.....	119	211
Operation.....	119	211
Elevation scales.....	123	218
Elevation. (See Pointing.)		
Emplacements, landward firing.....	197	340

INDEX

Equipment:	Paragraph	Page
Care.....	263-267	395
Destruction.....	267	397
Preservation.....	263-267	395
Used:		
Landward firing.....	199	341
90-mm AMTB batteries.....	180	328
Radar.....	227	368
Erdman compensator.....	50	55
Field artillery telescopes.....	136	253
Used with 155-mm guns.....	App. IX	467
15-foot coincidence range finder:		
Adjustment.....	55	71
Description.....	55	71
Operation.....	55	71
Theory.....	55	71
Fire adjustment:		
Landward firing.....	194	339
Lateral.....	154	280
90-mm AMTB batteries.....	185	333
Range.....	154, 157	280, 291
3-inch guns.....	162	296
Fire adjustment board M1:		
Description.....	152	278
Operation.....	154	280
Purpose.....	151	278
Setting up board.....	153	279
Fire control methods. (See Alternate fire control methods.)		
Firing data:		
Corrected.....	250	391
Gun data computer M8.....	224	365
Landward firing.....	192	338
Uncorrected.....	20, 21	15, 16
Firing data chart, 3-inch guns.....	159, 163	294, 297
Gun commander's control.....	175, 176	324, 325
Gun data computer M1.....	200-213	343
Auxiliary matériel.....	206	348
Description.....	202	344
Electrical data transmission systems.....	205	348
Horizontal base problem.....	208-211	350
Operation.....	204, 213	347, 356
Physical characteristics.....	201	344
Prediction formulas, derivation.....	App. X	478
Stand-by equipment.....	203	347
Time interval system.....	207	349
Gun data computer M8.....	214-224	358
Auxiliary matériel.....	220	362
Batteries.....	215	358
Components, description.....	216, 217	358, 359
Electrical data transmission systems.....	219	362
Operation.....	218	360
Prediction.....	223	365
Stand-by equipment.....	221	363
Theory.....	222-224	364
Gunner's Quadrant.....	122	215

INDEX

	Paragraph	Page
Gunner's Quadrant M1.....	122	215
Gunner's Quadrant, models (M1897, M1898, and M1918).....	122	215
Harbor defense water areas.....	7	2
Horizon, distances to.....	App. II	411
Horizontal base problem, gun data computer M1.....	208-211	350
Horizontal base system.....	14	10
Gun data computer M1.....	209, 212	350, 355
Operation, 90-mm AMTB batteries.....	183	331
Subcaliber practice.....	258	394
Hypothetical courses, use.....	243	384
Indicator, wind component. (See Wind component indicators.)		
Interval. (See Time intervals.)		
Lateral adjustment.....	154	280
Lateral adjustment scale. (See Deflection board M1.)		
Level of base ring, check.....	117	204
Level of trunnions.....	115, 125	203, 219
Logarithmic scales. (See Scales.)		
Lubrication.....	265	300
Maps, harbor defense.....	10	6
Maps, landward firing.....	191	337
Measurement of azimuth. (See Azimuth measurement.)		
Meteorological message.....	81	139
Application.....	81	139
Description.....	81	139
Modified one-station method.....	172	315
Modified range correction board M1923.....	92	154
Naval vessels, maneuverability.....	App. IV	414
Nine-foot coincidence range finder:		
Adjustment.....	56	82
Description.....	56	82
Operation.....	56	82
Theory.....	56	82
Nonstandard ballistic conditions.....	22	17
Observation, landward firing.....	193	338
Observer training.....	6, 232, 240	2, 373, 382
Observing and aiming point.....	9	5
Observing details.....	232	373
Observing interval, choice.....	42	37
110° plotting boards, M1915 and M1918:		
Description.....	71	107
Operation.....	73	111
Orientation.....	72	110
One-station fire control system.....	166-171	303
Application.....	171	314
Illustrative examples.....	168	307
Modified, using time-range board.....	172	315
Procedure.....	167	305

INDEX

	Paragraph	Page
One-station fire control system—Continued.		
Rules.....	170	313
Training.....	169	313
Optical parts.....	266	396
Panoramic telescopes.....	131	229
Description.....	131	229
M8.....	131	229
Panoramic telescope M8.....	131	229
Adjustment.....	131	229
Description.....	131	229
Operation.....	131	229
Percentage corrector M1:		
Description.....	94	154
Operation.....	95	158
Range-elevation scale.....	App. VI	434
Range-range relation tape.....	App. VI	434
Subcaliber practice.....	261	394
Plotter:		
Duties.....	234	375
Training.....	239	382
Plotting and relocating board:		
M1923 (cloke):		
Description.....	76	121
Operation.....	78	134
Orientation.....	77	127
M1.....	79	135
Plotting board accessories.....	64-70	96
Plotting boards.....	71-79, 253	107, 392
Plotting boards:		
M3 and M4:		
Description.....	74	112
Optical station arm.....	75	115
(See 110° plotting boards M1915 and M1918.)		
Plotting room details.....	234	375
Voice procedure.....	251	392
Pointing:		
Definition.....	110	202
Direction.....	112, 124-137	202, 219
Accuracy required.....	124	219
Adjustments for mobile artillery.....	135	248
By deflection angle.....	128	221
Case I and case II adjustment.....	126	220
Case III adjustment.....	127	220
Theory of pointing.....	128	221
Elevation.....	110, 114-123	202, 203
Adjustments for mobile artillery.....	120	212
Polar coordinates.....	App. VI	434
Position finding systems, standard.....	10	6
Pratt range correction board M1905 (modified).....	90	153
Prediction.....	63	94
Prediction formulas, gun data computer M1.....	210, App. X	478
Prediction scale.....	67	97
Description.....	67	97
Operation.....	67	97
Use.....	252	392
Prediction tests.....	245	384

INDEX

Quadrant sight M1918A1:		
Adjustment	121	213
Description	121	213
Operation	121	213
Quadrant. (See Elevation quadrant.)		
Quadrant. (See Gunner's quadrant.)		
Radar	17	14
Theory	226	367
Equipment	227	368
Use of equipment	228	368
Range adjustment	154, 157	280, 291
Range correction board:		
M1	93	154
M1923	91	154
M1A1:		
Accuracy tests	88	152
Adjustment	86	150
Description	85	147
Operation	87	151
Range correction board with 3-inch guns	164	297
Range correction boards, subcaliber practice	260	295
Range corrections	23	17
Range corrections, reference numbers	62	93
Range difference:		
Application	34	29
Chart	33	27
Formula	32	27
Range disks	118	208
Adjustment	118	208
Description	118	208
Graduation	App. VI	434
Operation	118	208
Range finding:		
Depression angle method	48	50
Systems, advantages	179	326
3-inch guns	160	295
Range officer	234	275
Range prediction, gun data computer M1	App. X	478
Range rake	150	276
Range section:		
Definition	229	370
Duties	231-234	372
Organization	230	370
Training	238-245	381
Reader:		
Duties	232	373
Training	241	383
Reconnaissance, landward firing	195	340
Rectangular coordinates	App. VI	434
References	App. XI	483
Refraction corrections	48	50
Relocation	7, 26	2, 20

INDEX

	Paragraph	Page
Scale, set-forward. (See Set-forward scale.)		
Scales:		
Construction:		
Logarithmic-----	App. VI	434
Nonuniform-----	App. VI	434
Range-elevation, percentage corrector		
M1-----	App. VI	434
Range-range relation tape, percentage corrector M1-----	App. VI	434
Uniform-----	App. VI	434
Instructions for obtaining-----	App. VII	411
Searchlights-----	187	334
Self-contained base system-----	16	13
Self-contained range finders-----	53-57	70
Set-forward devices-----	262	394
Set-forward point, location-----	63	94
Set-forward rule-----	67, 68	97, 100
Construction-----	68	100
Description-----	67	97
Operation-----	67	97
Set-forward scale-----	65, 66	96, 97
Construction-----	66	97
Description-----	65	96
Operation-----	65	96
Sight, quadrant. (See Quadrant sight.)		
Sights. (See Telescopes.)		
Single station system, 90-mm AMTB batteries-----	182	329
Spotting:		
Basic assumptions-----	App. VIII	464
Formulas-----	App. VIII	464
Landward firing-----	193	338
Purpose-----	138	256
Spotting board:		
M2-----	148	274
M3-----	142-147	261
Description-----	143	262
Mechanical adjustment-----	147	273
Mechanical check-----	146	272
Operation-----	145	271
Orientation-----	144	268
M7-----	149	275
Spotting boards-----	142-149	261
Theory-----	App. VIII	464
Spotting details-----	233	374
Spotting observers-----	139, 233	257, 374
Spotting stations-----	140	258
Spotting systems-----	141	258
Functioning-----	256	393
Stations. (See Alternate stations.)		
Stereoscopic range finder-----	57	88
Subcaliber practice-----	257-262	394
Swasey depression position finder:		
Adjustment and orientation-----	49	53
Description-----	49	53
Operation-----	49	53

INDEX

	Paragraph	Page
Targ-----	69	102
Target:		
Assignment-----	7	2
Recognition-----	5-9	2
Telescope M31. (See Telescopes.)		
Telescopes:		
Field artillery-----	136	253
Panoramic-----	131	229
Used in pointing:		
Adjustment-----	129	225
Description-----	129	225
Telescope M31-----	129	225
Temporary and stand-by fire control system,		
90-mm AMTB batteries-----	177-188	326
Timing-----	38-44	34
Examples-----	44	38
Operations-----	40	35
Time interval bells-----	39	34
Time intervals-----	41	36
Time interval system, gun data computer M1-----	207	349
Time-range board:		
Construction-----	70	102
Description-----	70	102
Modified one-station method, use-----	172	315
Operation-----	70	102
Tracking-----	13-19	9
Training:		
Battery personnel-----	238-245	381
Landward firing-----	198	341
90-mm AMTB batteries-----	188	335
Travel computer. (See Angular travel computer.)		
Uncorrected firing data:		
Elements-----	20	15
Determination-----	21	16
Universal deflection board:		
Accuracy tests-----	100	169
Description-----	97	162
Operation-----	99	163
Use-----	254	392
Zeroing-----	98	167
Wind component indicator:		
Description-----	83	143
Orientation and operation-----	84	144
Problem of wind correction-----	82	143
Use-----	255	392
Wind, reference numbers-----	61	92